

Air Flow Logger

AD-1641



Air Flow
(0 to 1.00 m/s)

Weighing Data
(from A&D's
balance/scale)



Cable length: 2 m

Temperature
(0 to 60 °C)

Humidity
(0 to 100% RH)

**Barometric
Pressure**
(500 to 1100 hPa)

Vibration
(0 to 2000 Gal)

***Not just a simple air flow logger, but the world's
most versatile environmental data logger!***



AND ...Clearly a Better Value
A&D Company, Limited
<http://www.aandd.jp>

Five Kinds Of Environmental Data With One Device!?

Now you can precisely capture **low-velocity air flows** of 0 to 1.00 m/s – together with **temperature, humidity, barometric pressure** and even **vibration** all at the same time – using nothing more than this single, portable and easy-to-mount device!

Diverse array of possible applications

For constant monitoring of the wind speed of a containment enclosure, laminar flow cabinet, etc.

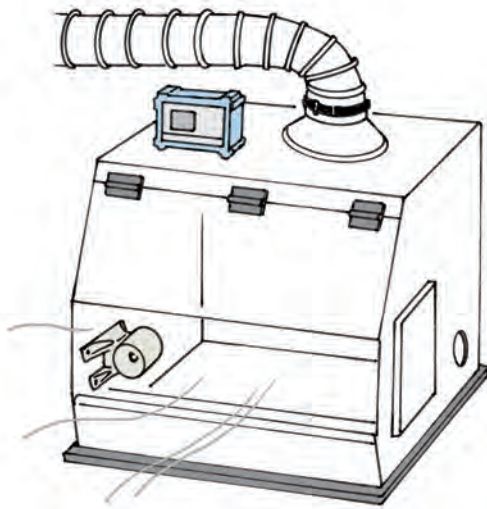

For managing the environmental factors that affect the stability of high-precision weighing instruments (e.g. microbalances)

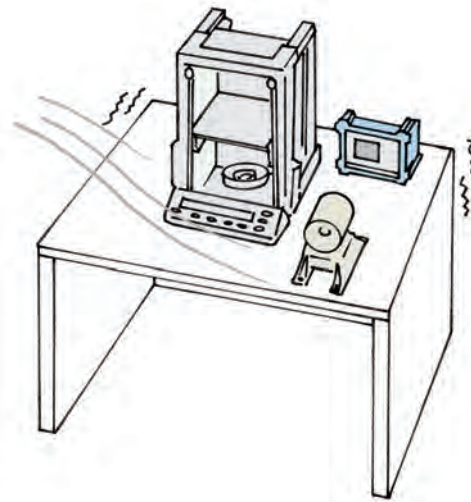

For creating and/or studying environments for nurturing delicate animals or plants

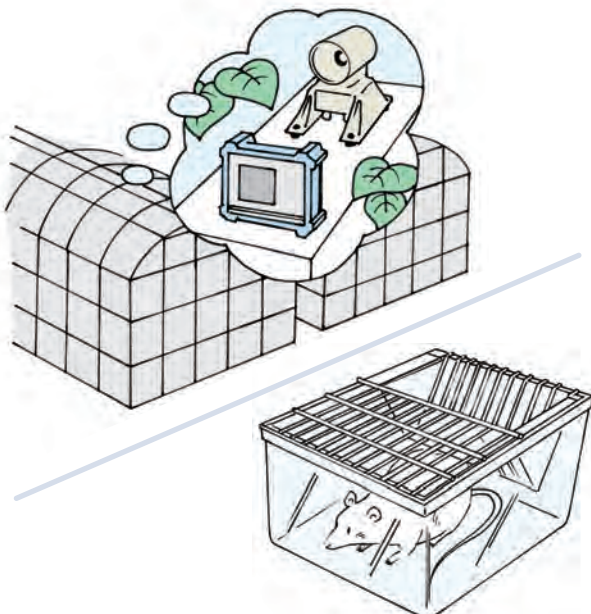

For controlling ambient conditions in laboratories, workshops, industrial processes, etc.

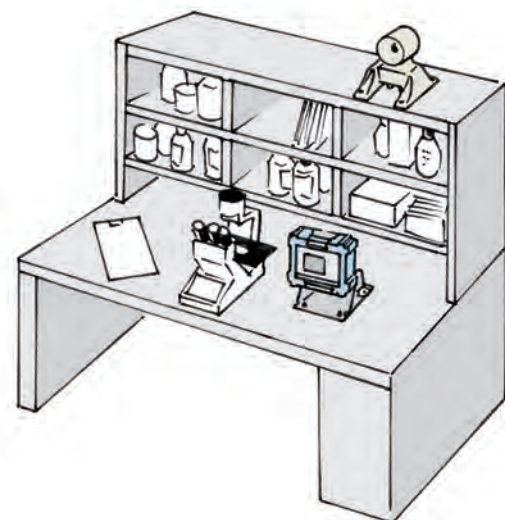

And so forth

Alarm for abnormal values (comparator function)

The AD-1641 lets you know by buzzer*¹ as well as by display if the selected environmental value (air flow, temperature, humidity or barometric pressure) has fallen outside the set upper and lower limits for the selected period of time (3 seconds, 10 seconds, or at once). This function is especially useful for ensuring the safety of containment systems.

*¹ Attached to the air flow sensor unit

Simultaneous logging of environmental and weighing data

When connected to an A&D balance/scale, the AD-1641 can save*² mass values sent from the balance/scale while simultaneously collecting the five kinds of environmental data, all with date and time of recording. There will no longer be the hassle of manually integrating data from different devices for later analysis and documentation.

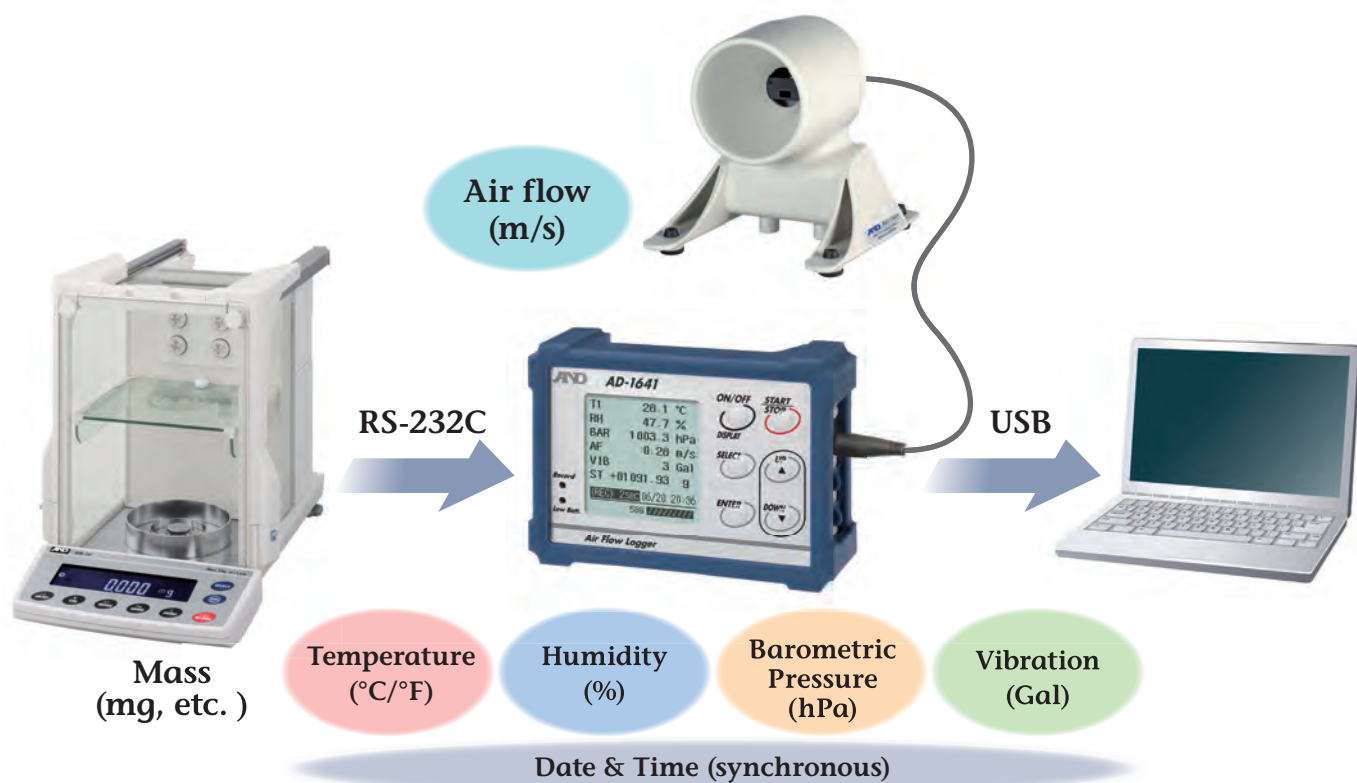

*² Up to 10,000 data sets, which is roughly 100 days' worth of continuous recording at a 15-minute interval

Quick data saving to a PC requiring no special software

The PC instantly recognizes the AD-1641 as USB storage. The data is stored in CSV format and can be opened using spreadsheet software such as Microsoft Excel, allowing for easy processing and graphing.

■ Real-time transmission mode

The AD-1641 can transfer environmental data (with or without weighing data) to a PC in real time instead of saving it on the device itself.

Protector against dust & water (IP65) as well as 1.5 m drop impacts

With the provided protective cover, the main unit of the AD-1641 becomes IP65 dust and waterproof for use under tough conditions. It also absorbs impact shocks enough to avoid breakage from falls from as high as 1.5 m.

Various display modes

You can choose to set the AD-1641 to display only two preferred data items instead of all for easier reading and monitoring (primary data mode), and display data by trend graphs instead of figures so as to intuitively grasp chronological variations or spot irregular changes (trend graph mode).

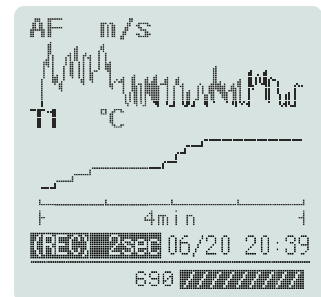
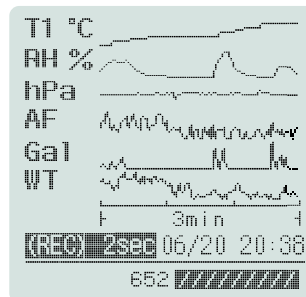
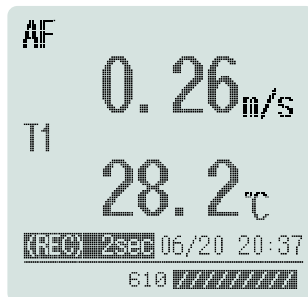
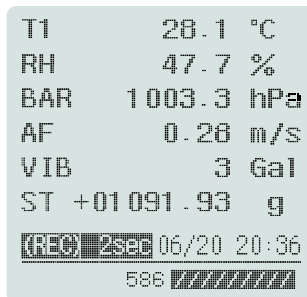

Specifications

	Resolution	Measurement range	Accuracy
Air flow	0.01 m/s	0 to 1.00 m/s	±0.05 m/s (0.10 to 1.00 m/s)
Temperature	0.1 °C 0.1 °F	0 to 60 °C 32 to 140 °F	±0.5 °C (20 to 30 °C) ±0.9 °F (68 to 86 °F)
Humidity	0.1% RH	0 to 100% RH	±3% (20 to 80%)
Barometric pressure	0.1 hPa	500 to 1100 hPa	±3 hPa (0 to 60 °C)
Vibration	1 Gal	0 to 2000 Gal	±20%, static acceleration

Data capacity	Maximum 10,000 sets (including date and time)
Interval time	1, 2, 5, 10, 15, 20, 30 seconds, 1, 2, 5, 10, 15, 20, 30, 60 minutes
Power supply	Two LR6 (AA) batteries or USB*1
Battery life	Approx. 20 hours (with alkaline batteries)
Clock accuracy	Maximum ±1 minute/month
Compatible operating systems	Windows 2000/XP/Vista/7/8 (32/64 bit)
Operating environment	0 to 60 °C/32 to 140 °F, 85% RH or less (no condensation)
Dimensions / weight	Main unit: 127 (W) × 90 (H) × 36 (D) mm (including the protector) / 275 g (including batteries and the protector) Air flow sensor unit: 90 (W) × 90 (H) × 91 (D) mm / 89.7 g
Standard accessories	<ul style="list-style-type: none"> Three RS-232C cables for weighing instruments (9-pin D-Sub, 25-pin D-Sub, and 7-pin DIN, 1 m) USB cable (2 m) Cable for the air flow sensor unit (2 m) Two R6 (AA) batteries (for operation check) Protector (for the main unit) Instruction manual

*1 No battery is required when connected to a PC or AC adapter (optional) via USB.

Options & Accessories

- AD-1687-22 Desktop/wall-mount stand
- AX-KO3986-150 Waterproof extension cable (1.5 m) for the thermo-hygrometer
- AX-TB265 AC adapter (AC 100 - 240 V; Interchangeable plugs - A/BF/C/S)



AD-1687-22



A&D Company, Limited
 3-23-14 Higashi-Ikebukuro, Toshima-ku, Tokyo 170-0013 JAPAN
 Telephone:[81](3) 5391-6132 Fax:[81](3) 5391-6148
<http://www.aandd.jp>

A&D ENGINEERING, INC.
 1756 Automation Parkway, San Jose, CA 95131 U.S.A.
 Telephone:[1](408) 263-5333 Fax:[1](408) 263-0119

A&D Australasia Pty Ltd.
 32 Dew Street, Thebarton, South Australia 5031 AUSTRALIA
 Telephone:[61](8) 8301-8100 Fax:[61](8) 8352-7409

A&D INSTRUMENTS LTD.
 Unit 24/26 Blacklands Way Abingdon Business Park,
 Abingdon, Oxon OX14 1DY UNITED KINGDOM
 Telephone:[44](1235) 550420 Fax:[44](1235) 550485

<German Sales Office>
 Hamburger Straße 30 D-22926 Ahrensburg GERMANY
 Telephone:[49](0) 4102 459230 Fax:[49](0) 4102 459231

A&D KOREA Limited
 817, Manhattan Bldg., 33, Gukjegeumyung-ro 6-gil,
 Yeongdeungpo-gu, Seoul, 150-749, KOREA
 Telephone:[82](2) 780-4101 Fax:[82](2) 782-4280

A&D RUS CO., LTD.
 Vereyskaya str.17, Moscow, 121357 RUSSIA
 Telephone: [7] (495) 937-33-44 Fax: [7] (495) 937-55-66

A&D Instruments India Private Limited
 509 Udyog Vihar Phase V
 Gurgaon-122 016, Haryana, INDIA
 Telephone: [91](124) 471-5555 Fax: [91](124) 471-5599