

RV-10000A

Vibro Rheometer

INSTRUCTION MANUAL



1WMPD4002930B

© 2015 A&D Company, Limited All rights reserved.

No part of this publication may be reproduced, transmitted, transcribed, or translated into any language in any form by any means without the written permission of A&D Company, Limited.

The contents of this manual and the specifications of the instrument covered by this manual are subject to change for improvement without notice.

CONTENTS

1. INTRODUCTION	5
1-1 Compliance.....	5
1-2 Features.....	6
2. UNPACKING THE RHEOMETER	8
2-1 Part names	8
2-2 Connecting the controller to the main unit.....	11
2-3 Connecting a USB memory	11
3. SYSTEM CONFIGURATION	12
3-1 Measurement by automatic amplitude changes using the controller	12
3-2 Measurement using a personal computer	13
4. DISPLAY AND KEYS	14
4-1 Main unit Display	14
4-2 Keys.....	15
4-3 Controller screen and operation	16
4-4 Displaying the Viscosity Values	17
5. PRECAUTIONS	18
5-1 General Precautions	18
5-2 During Use.....	19
5-3 After Use	20
5-4 About viscosity measured with the RV	22
5-5 About the relation among amplitude value, shear rate and viscosity	24
6. MEASUREMENT	25
6-1 Preparing the Sample.....	25
6-2 Measurement using the controller (Auto mode)	27
6-3 Measurement using the controller (Program mode).....	31
6-4 Graphing CSV data	35
6-5 Measurement using only the main unit.....	36
7. USING THE WATER JACKET	40
7-1 Introduction	40
7-2 Installation.....	41
7-3 How to Use	43
7-4 Measuring the Absolute Value of Viscosity Using the Small Sample Cup	44
7-5 Maintenance	44
7-6 Specifications	44
8. USING THE DISPOSABLE CUP	45
8-1 Introduction	45
8-2 How to Use	45
8-3 Measuring the Absolute Value of Viscosity Using the Disposable Cup	46
8-4 Specifications	46
9. VISCOSITY CALIBRATION	47
9-1 Notes on Viscosity Calibration.....	48
9-2 Calibration Procedure	49

10. MAIN UNIT FUNCTION SETTING	55
10-1 Operation	55
10-2 Details of the Function Items	57
10-3 Description of Items	58
10-4 Data Output Format Examples	66
11. SETTING THE CONTROLLER.....	72
11-1 Setting the date and time	73
11-2 Setting the display backlight brightness	74
11-3 Numerical value entry dialog	75
11-4 Character entry dialog	76
11-5 Pulldown selection dialog	76
12. CONNECTION TO A PERSONAL COMPUTER.....	77
12-1 Introduction	77
12-2 Installation of WinCT-Viscosity	77
12-3 Connection to a personal computer	77
12-4 Configuration of the COM port	78
12-5 Controlling the measurement using a personal computer.....	79
13. CONNECTION TO A PRINTER.....	80
14. RS-232C INTERFACE	81
15. COMMAND LIST	83
16. TROUBLESHOOTING.....	84
16-1 When measurement values do not become stable	84
16-2 When measurement values are not correct	86
16-3 When more precise measurement is required:	87
16-4 When the temperature values are not correct.....	87
16-5 When water viscosity is to be measured	87
16-6 When the controller and the main unit are not communicating.....	87
17. ERROR DISPLAY	88
18. SPECIFICATIONS	89
19. OPTIONAL ACCESSORIES.....	91
20. EXTERNAL DIMENSIONS	98

1. INTRODUCTION

This manual describes how the rheometer RV-10000A works and how to get the most out of it in terms of performance.

Read this manual thoroughly before using the rheometer and keep it at hand for future reference.

1-1 Compliance

Compliance with FCC Rules

Please note that this equipment generates, uses and can radiate radio frequency energy. This equipment has been tested and has been found to comply with the limits of Class A digital devices pursuant to Part 15 of FCC rules. These rules are designed to provide reasonable protection against interference when equipment is operated in a commercial environment. If this unit is operated in a residential area, it may cause some interference and under these circumstances the user would be required to take, at his own expense, whatever measures are necessary to eliminate the interference. (FCC = Federal Communications Commission in the U.S.A.)

1-2 Features

- High accuracy
The Vibro Rheometer adopting the Tuning-fork Vibration Method, achieves a high measurement accuracy of 1% (repeatability) over the full range.
- Because the amplitude of the sensor plates can be changed automatically with the provided controller, viscosity changes can be measured by the changes in the shear rate and graphs can be confirmed on the controller in real time.
- Measurement results can be output to a USB memory in CSV or JPEG format.
- Because amplitude with the sensor plates can be changed, viscosity change can be measured by change in shear rate.
- The sensor plates are made of corrosion resistant titanium. Although titanium is a chemically stable material, it is corroded by some liquid such as sulfuric acid. So, handle it with much care.
- Wide range continuous measurement
Continuous measurement over the whole measuring range is possible, without replacing the viscosity detection sensor plates.
- Standard temperature sensor
The temperature sensor to measure the sample temperature is installed as standard. The temperature sensor is located between the two sensor plates. So, the accurate detection of the relation between temperature and viscosity is possible.
- Accurate measurement
Due to the low heat capacity of the viscosity detection unit (sensor plates and temperature sensor), the time required for temperature equilibrium is short. Thus, the sample viscosity can be measured accurately in a short time.
- Long continuous measurement time
The sensor plates, with a low frequency of 30 Hz, apply very little load to the sample. So, the rheometer can continuously obtain stable viscosity values without causing a temperature rise or damaging the sample.
- The sine-wave vibro rheometer (viscometer) measures “viscosity × density”. While viscosity (mPa·s) is used as the unit for measuring, this is displayed assuming that density is 1g/cm³.
- Measurement of a non-Newtonian fluid/foaming sample
The thin sensor plates allow little deformation of the sample texture. Thus, non-Newtonian fluid can be measured in a stable way. And, foaming samples (whipped cream, etc.)) can be measured without breaking minute foam particles and with less influence scattering large foam particles.
When measuring tap water, bubbles may accumulate on the sensor plates, increasing the viscosity.
- Viscosity measurement of a flowing sample
The two sensor plates oscillate in the opposite direction. So, even when a sample is in motion, errors are eliminated. This allows measurement of a sample while being stirred. Therefore, the rheometer can be used for a continuously flowing product line, which enables field management with identical data used at the laboratories.

- Calibration
The rheometer can be calibrated using a standard viscosity fluid or a sample of a known viscosity. Calibration allows the rheometer to maintain the accuracy constantly.
- Simplified calibration when measuring the viscosity near 1 mPa·s
Simplified calibration using purified water is a one-key operation. The rheometer has a built-in function to measure the temperature of the purified water using the temperature sensor and calculates the viscosity value of the purified water at that temperature.
At this time, be careful not to influence the viscosity value by generating bubbles.
- Standard windows communication tools WinCT-Viscosity
Windows communication tools WinCT-Viscosity (CD-ROM) is provided as standard. The CD-ROM includes the graphing program RsVisco, which imports the data into a personal computer and displays the results as a graph in real time. With RsVisco, changes in viscosity over time and temperature dependency of viscosity can be observed easily and the obtained data can be saved in files.
- When using the accessory serial-USB converter, the personal computer can input the data using the personal computer's USB port.
- The cup, that the sample is to be measured in, can be the plastic sample cup and the glass sample cup. When measuring an organic solvent, use the glass sample cup.
- The 7-inch color LCD controller touch panel provides excellent visibility and operability.

2. UNPACKING THE RHEOMETER

- The rheometer is a precision instrument. Unpack the rheometer carefully. Keep the packing material to be used for transporting the rheometer in the future.

2-1 Part names

* The illustration below is after assembling.

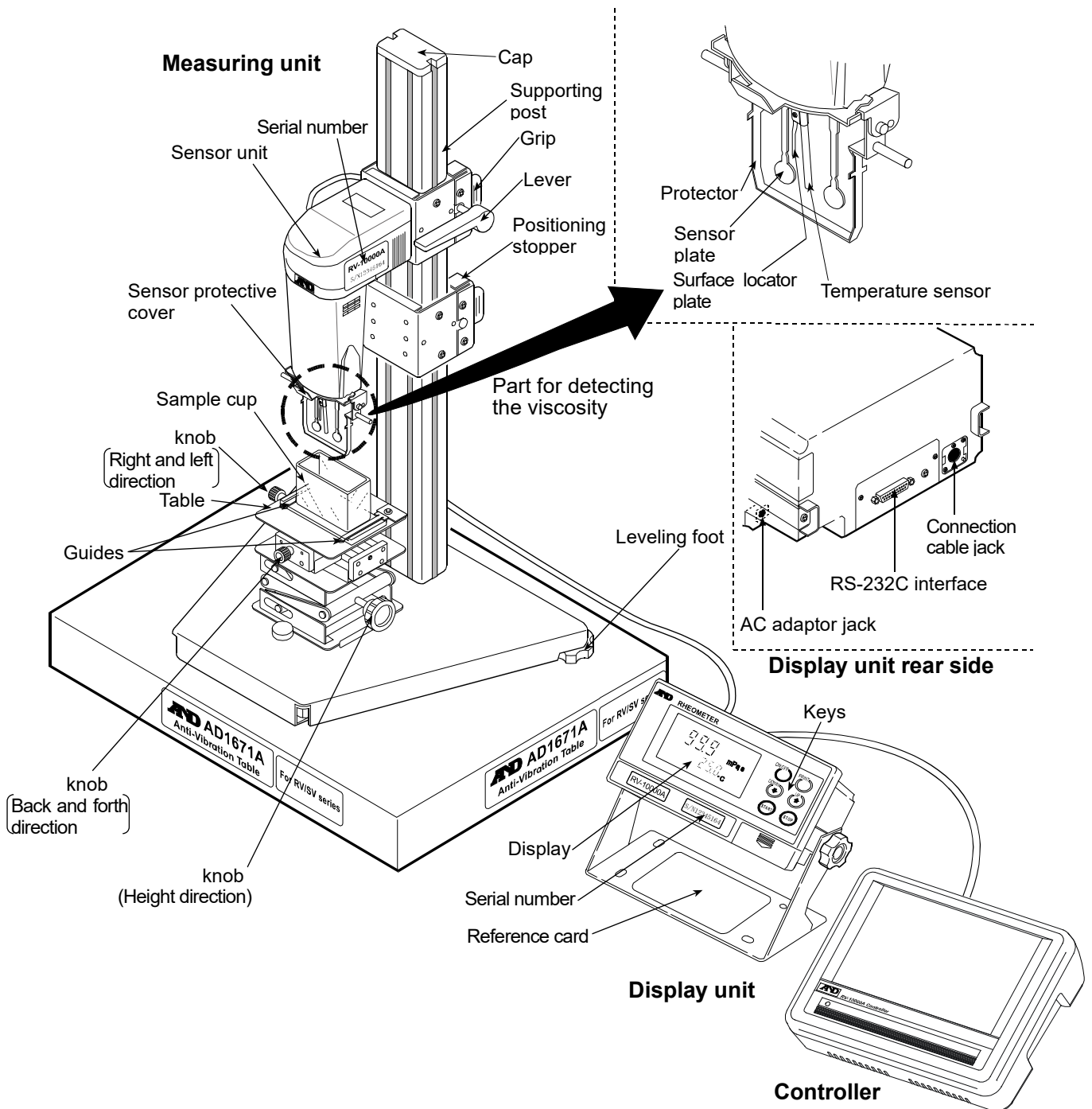

Accessories

Connection cable (1 pc)

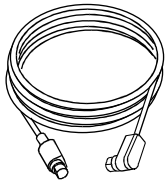

AC adapter (1 pc)

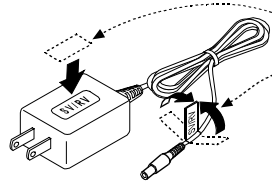

AC adapter label

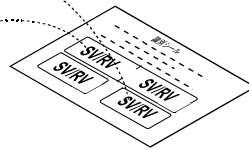

Note:
Affix the labels to the AC adapter, as illustrated here.

Sample cup
(Polycarbonate, Capacity: 45 mL,
5 pcs)

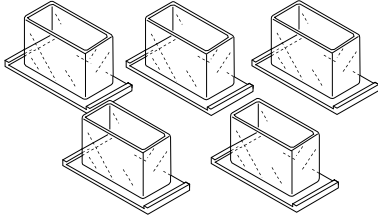

Small sample cup
(Polycarbonate, Capacity: 10 mL,
5 pcs)

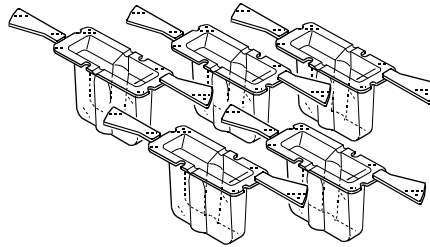

Small sample cup cover
(Polycarbonate, 5 pcs)

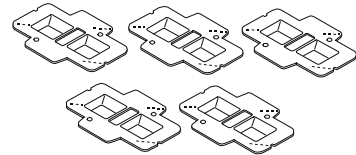

Disposable cup
(Polyethylene terephthalate,
Capacity: 10 mL, 5 pcs)

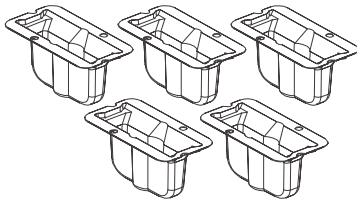

Glass sample cup
(Capacity: 13 mL, 2 pcs)

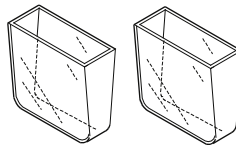

The position about 25 mm
above the cup bottom
indicates 13 mL.

Glass sample
cup holder
(1 pc)

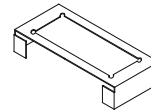

Water jacket (1 pc)

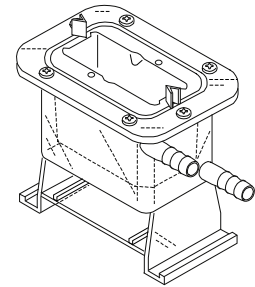

Windows communication tools
WinCT-Viscosity (CD-ROM) (1 pc)

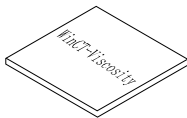

RS-232C cable (1 pc)
25P-9P for modem

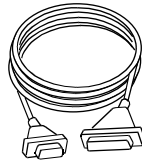

Serial-USB converter (1 pc)

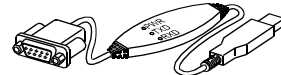

Stand for securing the sensor unit (1 pc)
Positioning stopper (1 pc)

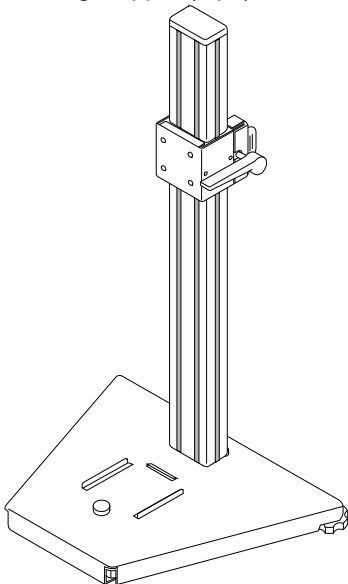

X-Y-Z stage (1 pc)

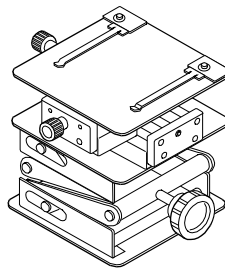

Anti-vibration table (1 pc)
AD1671A

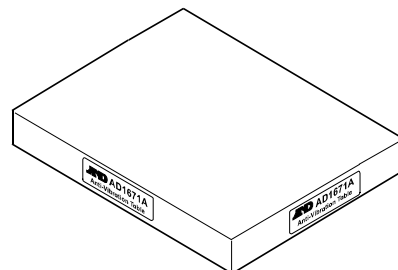

Dust Cover (for the Measuring unit, Display unit and Controller of RV-10000A)
 (Material: Nylon, Color: Light gray)

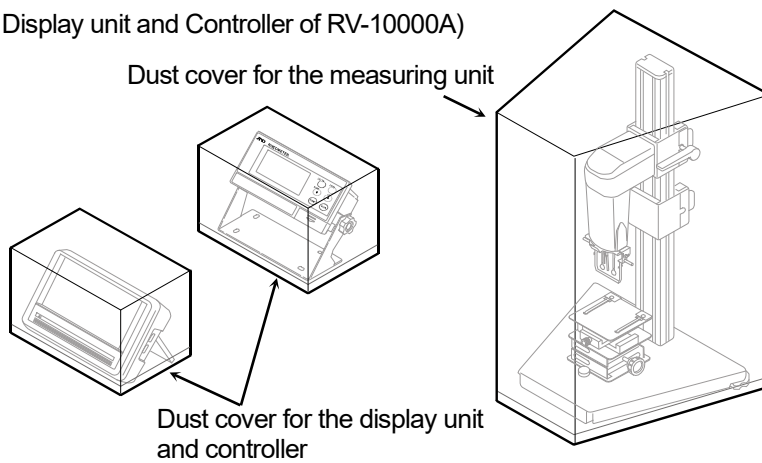

Controller

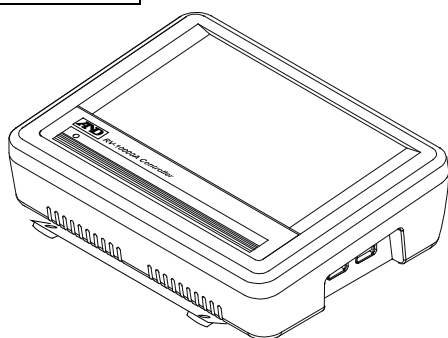

Right side view

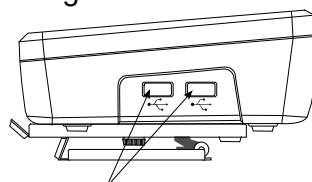

USB interface
 (To connect a USB memory)

Rear view

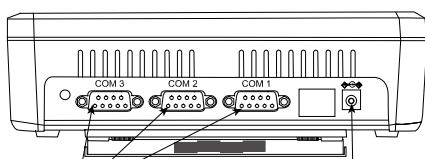

RS-232C interface

AC adapter jack

Left side view

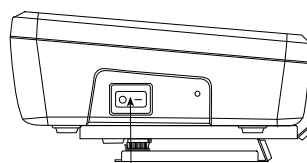

Power switch

Accessories

AC adapter (1 pc)

Note:

Affix the labels to the AC adapter, as illustrated below.

Touch pen (1 pc)

Touch pen holder (1 pc)

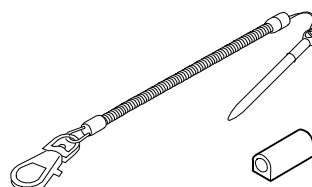
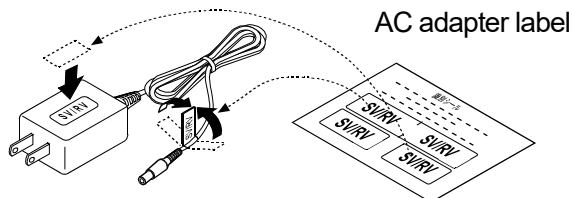

Note

- Please confirm that the AC adapter type is correct for your local voltage and receptacle type.
- Use the dedicated AC adapter specified for the rheometer.
- Do not use the AC adapter provided with the rheometer for equipment with which the AC adapter may not be compatible.
- If you use the wrong AC adapter, the rheometer and other equipment may not operate properly.

2-2 Connecting the controller to the main unit

Use the provided RS-232C cable to connect the controller to the main unit.

Use one of COM1 to COM3 connectors on the rear side.

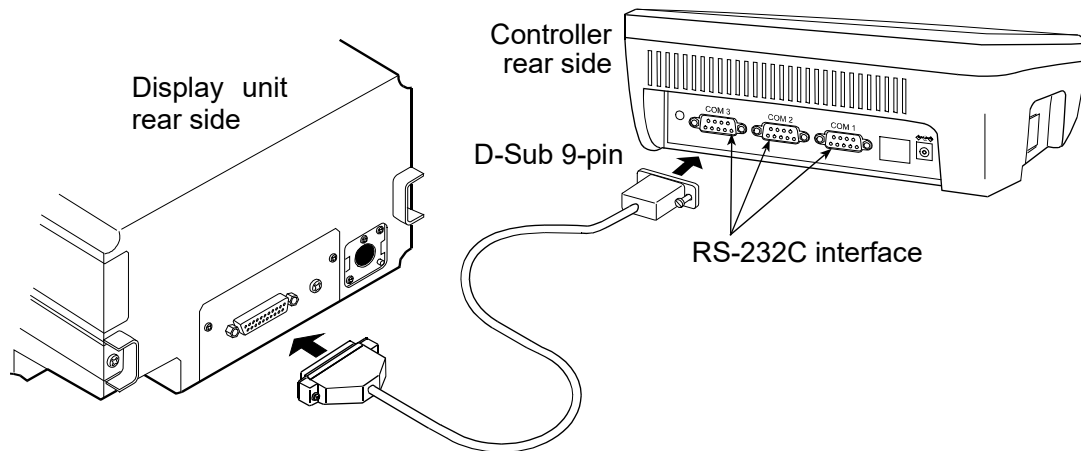

2-3 Connecting a USB memory

Measurement results can be output to a USB memory as a JPEG file or a CSV file. Using a personal computer, those data can be managed or printed.

Insert a USB memory into the USB interface located on the controller right side.

Use either one of the two USB interfaces. The two interfaces cannot be used at the same time.

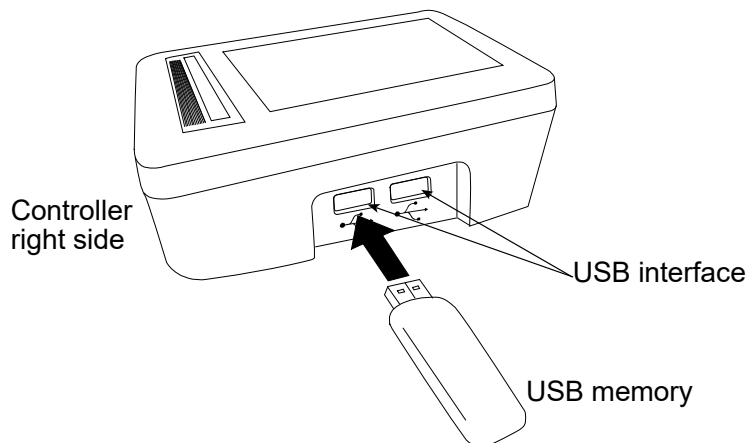

3. SYSTEM CONFIGURATION

3-1 Measurement by automatic amplitude changes using the controller

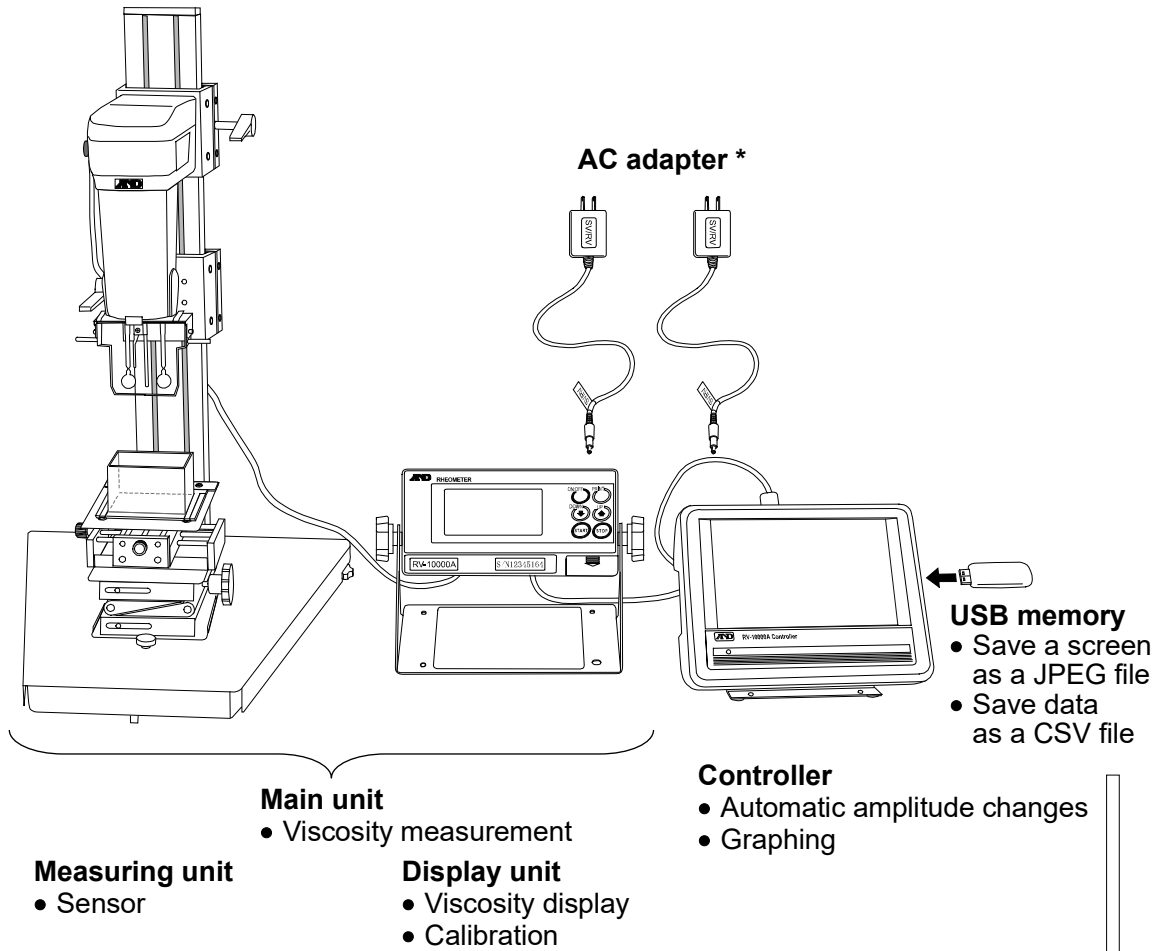

* After connecting the connection cables, insert the AC adapters into both the controller and display unit. (AC adapters have the same catalog number.)

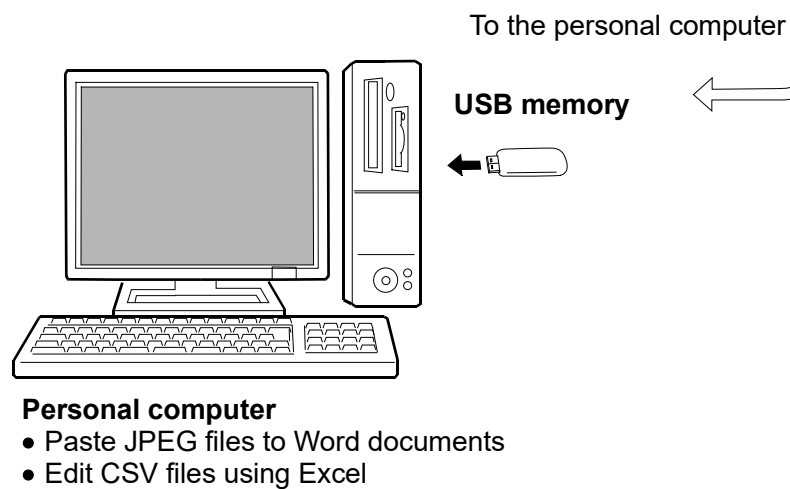

3-2 Measurement using a personal computer

* The amplitude cannot be changed automatically.

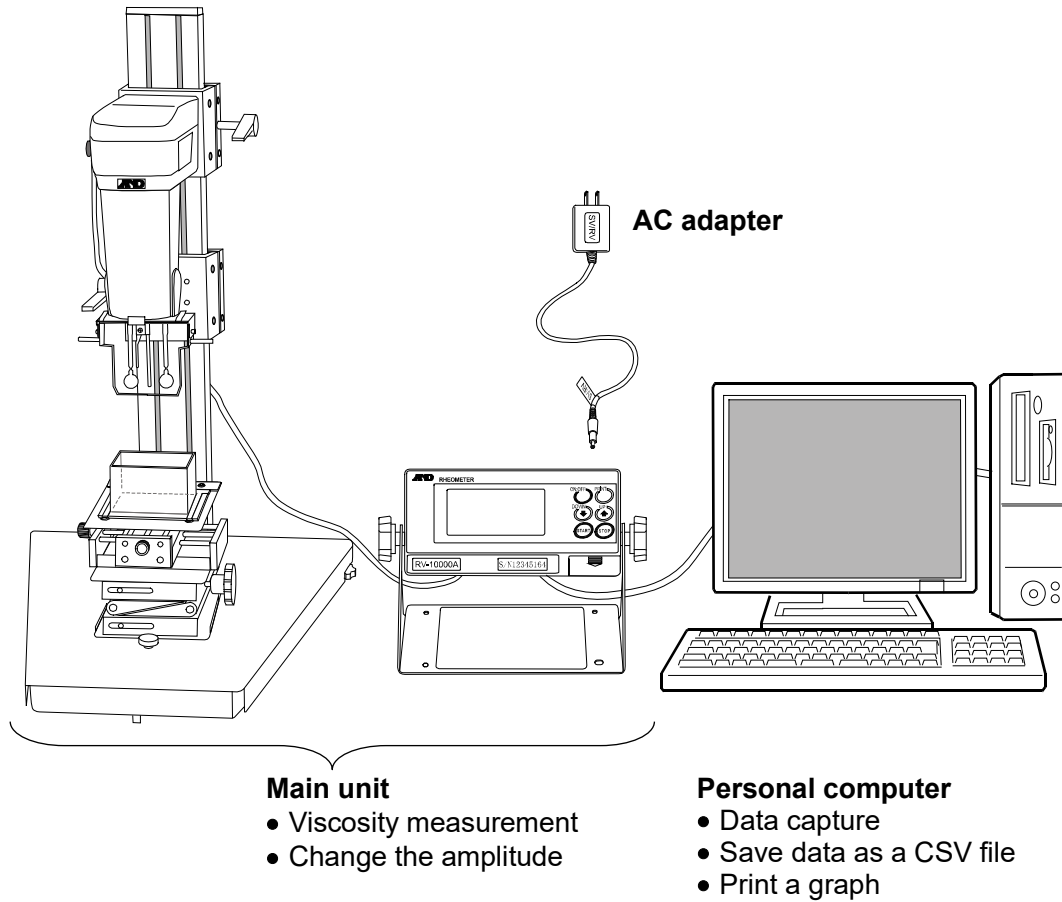

For measurements using a personal computer, Windows communication tools "WinCT-Viscosity" is required. Please install it using the provided CD-ROM.

4. DISPLAY AND KEYS



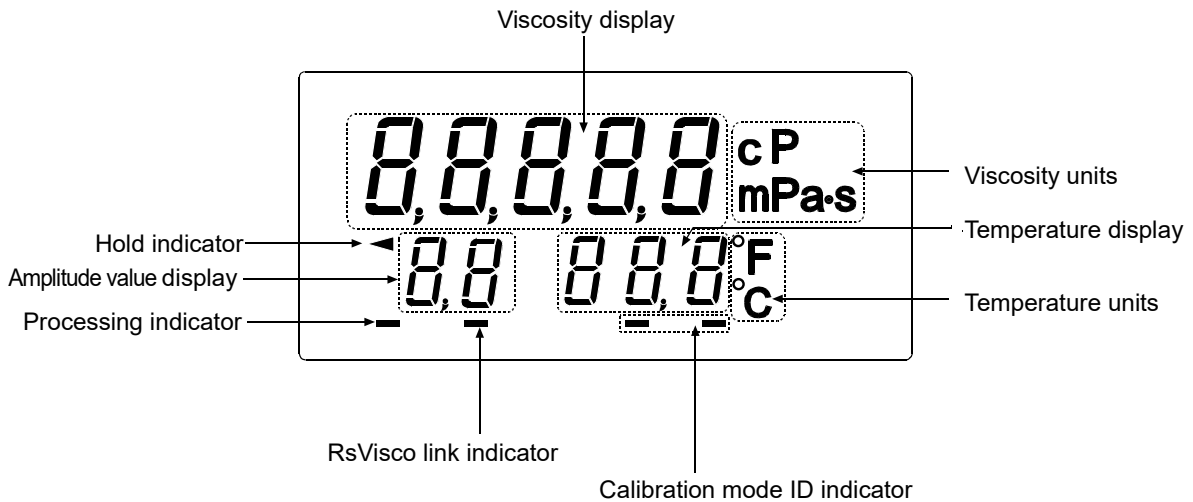

4-1 Main unit Display

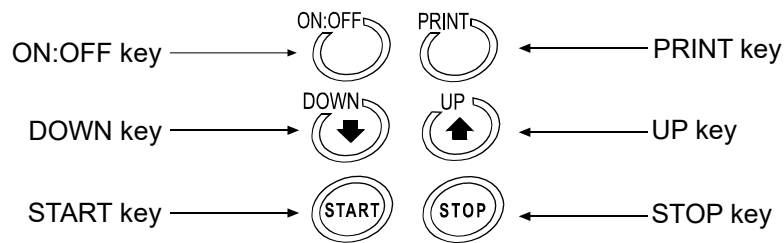

Name	Description		
Viscosity display	Standby mode	Displays [- - - -].	
	Measurement mode	Displays the viscosity value in real time.	
Viscosity units	Displays the unit of viscosity.		
Temperature display	Standby mode	Displays the temperature value in real time.	
	Measurement mode		
Temperature units	Displays the unit of temperature.		
Processing indicator	Blinks while the measurement is being performed. (While the sensor plates are in vibrating motion)		
RsVisco link indicator	Illuminates when connected to the controller or while measurement is being performed using "RsVisco", the graphing program included in the WinCT-Viscosity (CD-ROM).		
Calibration indicator	Displays " [" in the calibration mode.		
Calibration mode ID indicator	At one-point calibration	Blank display []	
	At two-point calibration	Inputting first point	Displays [- -].
		Inputting second point	Displays [- -].
Amplitude value display	Displays the amplitude value.		

4-2 Keys

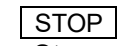
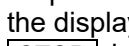
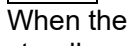

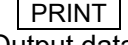
Key	Description
 Power	Turns the power on and off. When the power is turned on, the rheometer enters the standby mode ([- - - -] is displayed.)
 Start measurement	Start a measurement. (The processing indicator blinks.) Displays the viscosity and temperature values in real time during measurement. If the display is set to HOLD, release it by pressing the  key.
 Stop measurement	Stops the measurement (The processing indicator is off) and freezes the display of the viscosity and temperature values at the time the  key is pressed during measurement. When the  key is pressed again, the rheometer enters the standby mode.
 Decrease amplitude value	Press and release: Decreases the amplitude value gradually. Press and hold: Enters the calibration mode.
 Increase amplitude value	Press and release: Increases the amplitude value gradually. Press and hold: Puts into function setting mode.
 Output data	Outputs the measurement data.

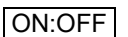
* When using the controller for measurements, use only the  key.

4-3 Controller screen and operation

Turn the Power switch on (I side). After the startup screen, the HOME screen appears.

4-3-1 Home screen

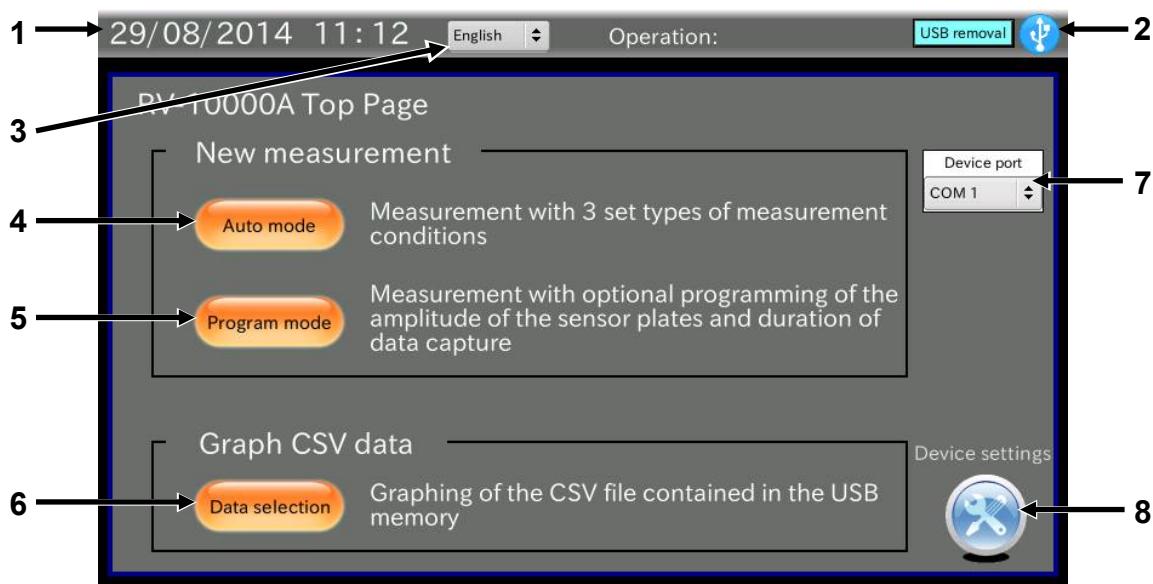

No.	Name	Description
1	Date·Time	Displays the date and time in the format specified in the Date, Time settings screen. Set the date and time using the "11. SETTING THE CONTROLLER".
2	USB mark	Displays the connection status to a USB memory. When being not connected, the symbol is crossed out with an X. When removing a USB memory, please touch the USB removal , or data may be damaged.
3	Language	Select English or Japanese.
4	Auto mode button	Measurement with 3 set types of measurement conditions. Refer to "6-2 Measurement using the controller (Auto mode)".
5	Program mode button	Measurement with optional programming of the amplitude of the sensor plates and duration of data capture. Refer to "6-3 Measurement using the controller (Program mode)".
6	Data selection button	Graphing the measurement data collected (CSV file) with the controller.
7	Device port	Select a COM port to connect the main unit.
8	Device settings	Sets the controller date and time, and LCD backlight brightness.

4-4 Displaying the Viscosity Values

The viscosity values are displayed as below, depending on the viscosity range and the unit selected in the main unit function setting.

The correlation of the units are as follows: 1 mPas = 0.001 Pa·s = 1 cP = 0.01 P

It is possible to switch between mPa·s (Millipascal second) and Pa·s (Pascal second), or between cP (Centipoise) and P (Poise), using the main unit function setting. (Refer to “10. MAIN UNIT FUNCTION SETTING”.)

The unit selected at the factory before shipment is mPa·s.

When the viscosity unit is mPa·s or Pa·s:

Viscosity measured	Unit selected								
	mmPa·s				Pa·s				
MmPa·s	Display	Minimum display	Unit	Remarks	Display	Minimum display	Unit	Remarks	
1	0.30 1.00 9.99	0.01	mmPa·s		0.0003	0.0001	Pa·s	Digit indicating 0.01 mPa·s is not displayed	
10	10.0 99.9	0.1			0.0010				0.0099
100	100 999	1			0.100				0.0999
1000	1.00 10.00	0.01			1.00 10.00				0.001
10000			Pa·s	Switches to Pa·s					

When the viscosity unit is cP or P:

Viscosity measured	Unit selected								
	CcP				P				
MmPa·s	Display	Minimum display	Unit	Remarks	Display	Minimum display	Unit	Remarks	
1	0.30 1.00 9.99	0.01	CcP		0.0030	0.0001	P		
10	10.0 99.9	0.1			0.0100				0.0999
100	100 999	1			0.100				0.999
1000	10.0 100.0	0.1			1.00 10.0				0.01
10000			P	Switches to P					

5. PRECAUTIONS

To get the optimum performance from the rheometer and acquire accurate measurement data, note the following:

5-1 General Precautions

For accurate measurement, use care with the following conditions.

- Install the rheometer in an environment where the temperature and humidity are not excessive. The best operating temperature is $25^{\circ}\text{C} \pm 2^{\circ}\text{C}$ at 45 - 60% relative humidity.
- For precise measurement, install the rheometer where there are no great changes in temperature and humidity.
- Install the rheometer where it is free of dust.
- The rheometer uses the Tuning-fork Vibration Method. So, use much care to avoid external vibration, especially when measuring low viscosity.

Places where the rheometer is prone to vibration are:

Second or higher floor, soft ground, near busy highways or rail lines.

Avoid these places as a measuring site. If measurement is to be performed in such a place, use an anti-vibration table that is available as an option (AD-1671A).

- Do not measure where heaters or air conditioners can affect the measurement.
- Do not measure where direct sunlight can affect the measurement.
- Install the rheometer away from equipment which produces magnetic fields.
- Protect the internal parts from liquid spills and excessive dust.
- Do not disassemble the rheometer.
- When precise measurement is required, acclimatize the rheometer to the measuring environment. After installation, plug in the AC adapter and warm up the rheometer for one hour or more.

5-2 During Use

- The RV-10000A rheometer, designed for very accurate measurement, is sensitive to vibration or shock during transportation, as that may cause a display value error. Before measurement, calibrate the rheometer using the sample cup that will be used for measurement.
- To level the surface of the sample, adjust the leveling feet. (Height adjustment of the right and left leveling feet.)

How to adjust the level

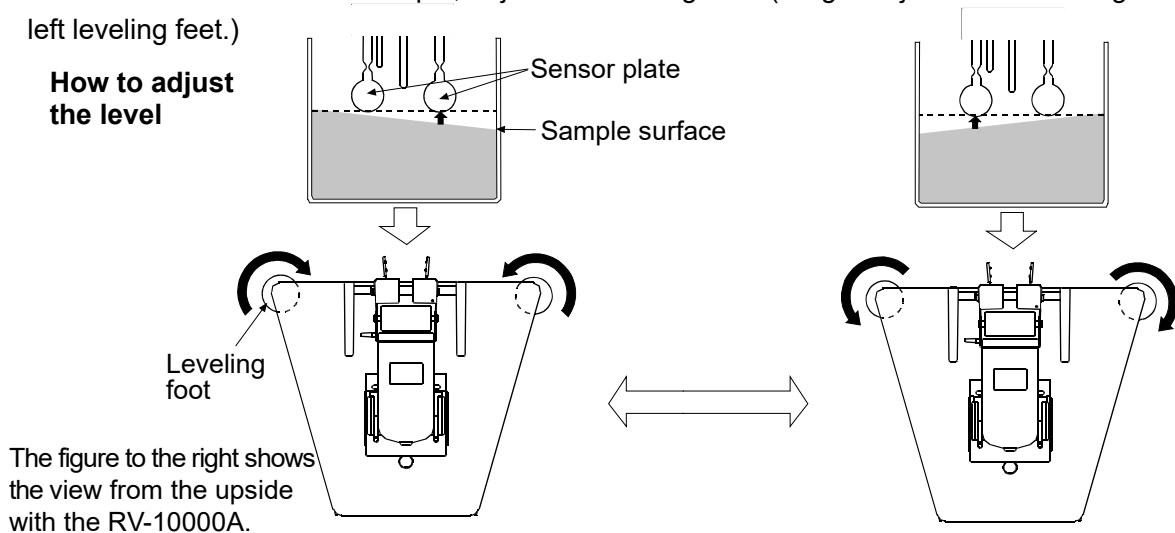

- In general, a viscosity value with a liquid changes in accordance with temperature change (In general, if increasing the temperature, the viscosity value decreases about 2 to 10 percent per degree Celsius). Take changes in the liquid temperature into consideration for an accurate measurement.
- Be sure to calibrate using the standard viscosity fluid or purified water before measurement. In a measurement that takes a long time, perform calibration periodically, as necessary.
- Ensure a stable power source when using the AC adapter.
- Placing the sensor plates and the temperature sensor in the sample may change the sample temperature. For precise measurement, leave the sample as is for a while, after placing the sensor plates and the temperature sensor, to ensure no changes to the sample temperature. And then, start a measurement.
- Use only your finger to press the keys. Using a sharp instrument such as a pen may damage keys.
- Handle the sensor plates with care.
- If the sensor plates, or the protector, touch the inner wall of the sample cup, it may cause measurement error. When measuring, be sure to adjust the spacing between the sensor plates and the inner walls of the sample cup.
- The sample cups are made of polycarbonate (PC) or glass. When using organic solvents, we recommend the use of the glass sample cup (accessory or sold separately) or a commercially available glass beaker.
Raise or remove the protector if necessary.

Precautions to be taken with the sample cup used

When the sample cup for measuring is changed, that may cause a change in the displayed viscosity value. Therefore, we recommend that you calibrate the rheometer using standard viscosity fluid. (Refer to [“7-4 Measuring the Absolute Value of Viscosity Using the Small Sample Cup”](#) for details.)

How to remove the protector:

Press the left and right side frames lightly in the direction indicated as 1 to remove the rotational axis. Pull the protector in the direction indicated as 2 to remove.

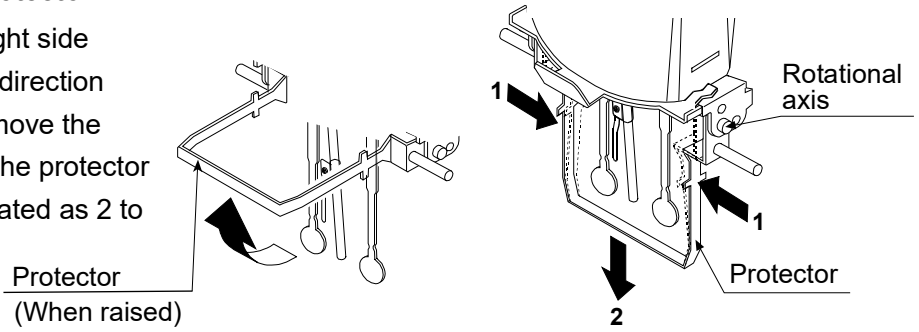

5-3 After Use

- Remove any residual sample material from the sensor plates, temperature sensor and protector using alcohol. Using the sensor plates, temperature sensor and protector with residue of an old sample left on will cause a measurement error. Clean the sensor plates carefully to avoid bending them. The sensor plates and the temperature sensor are made of titanium.

How to clean the sensor plates and temperature sensor

Hold the sensor plate or temperature sensor with tissue paper. Move the tissue paper downward to remove the sample. Then, use tissue paper moistened with alcohol, to remove any residual sample material.

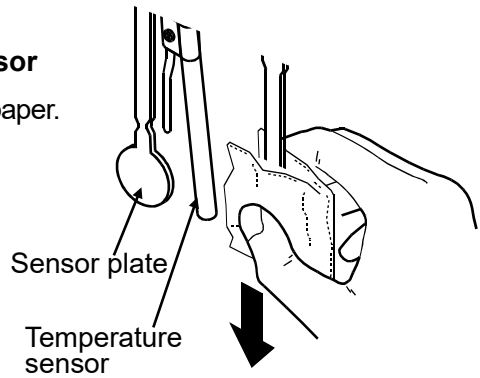

- Clean the sample cup as necessary.
- Unlock the cable connector before disconnecting the connection the cable.

How to unlock the cable connector

Display unit

Hold the cable connector to unlock

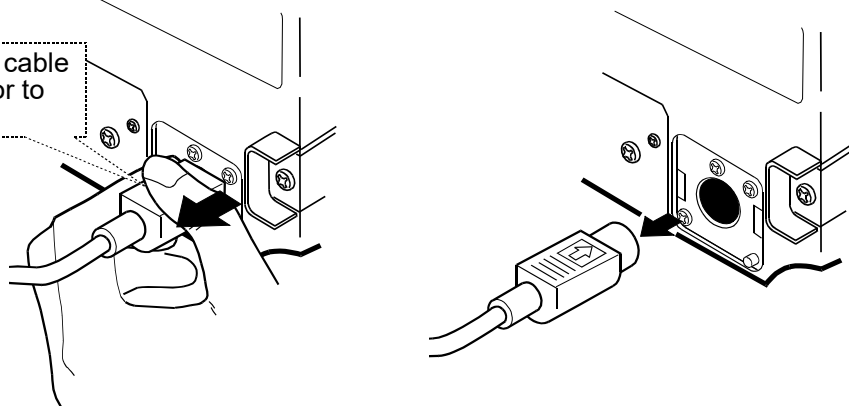

Sensor unit

Press the protrusion to unlock.

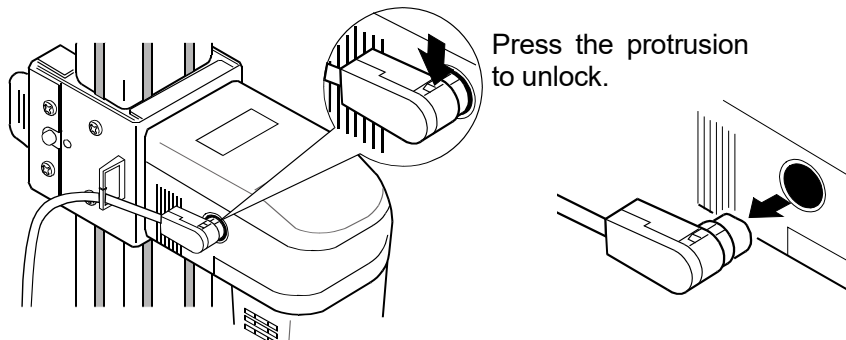

Storing the rheometer

Use the dust cover to protect the instrument from dust and dirt during storage.

- Place the rheometer where it is free of dust.
- The dust cover can be used while the rheometer is connected to the AC adapter and other cables.
- When removing the dust cover, take care not to get its edge caught on the rheometer.
- Specifications

Material: Nylon

Color: Light gray

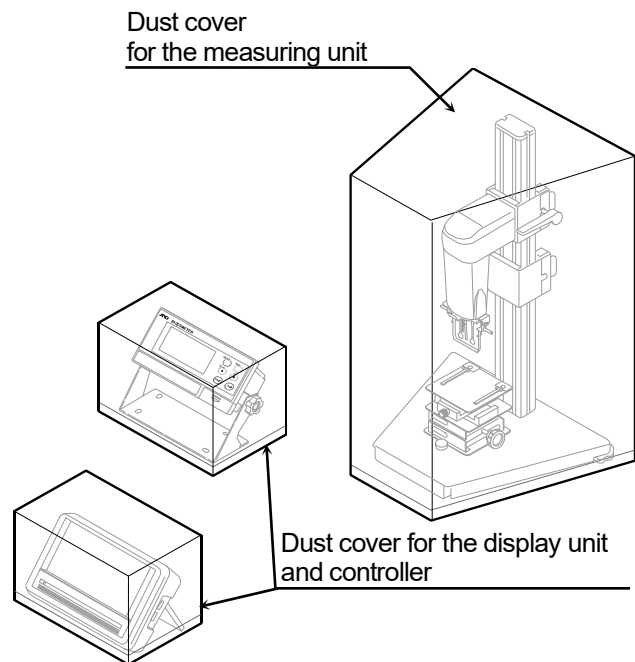

5-4 About viscosity measured with the RV

When the sample cup for measuring is not a sample cup with 45mL capacity, viscosity will change at a value where viscosity is several thousand mPa·s or more. Therefore, calibrate using standard viscosity fluid by the cup used.

The RV-10000A Sine-wave Vibro Rheometer, as a measuring principle, detects the product of viscosity and density (defined as “static viscosity”).

$$\text{Static viscosity} = \text{Viscosity} \times \text{Density} \dots\dots [1]$$

While the displayed value has a unit of mPa·s, it indicates the product of viscosity and density.

Example (1) When a sample has a viscosity of 2.00 mPa·s and density of 1.000:

$$\begin{aligned} \text{Displayed value} &= 2.00 \text{ [mPa}\cdot\text{s]} \times 1.000 \\ &= 2.00 \text{ [mPa}\cdot\text{s]} \end{aligned}$$

(2) When a sample has a viscosity of 2.00 mPa·s and density of 0.800:

$$\begin{aligned} \text{Displayed value} &= 2.00 \text{ [mPa}\cdot\text{s]} \times 0.800 \\ &= 1.60 \text{ [mPa}\cdot\text{s]} \end{aligned}$$

Note

The density can be measured, using the density determination kit, AD-1653 in combination with a balance.

To obtain the absolute viscosity value precisely, do as follows:

5-4-1 At Measurement

Divide the static viscosity by the sample density to obtain the viscosity.

Example (1) Measure the sample and confirm the static viscosity.

Here, 736 mPa·s as an example.

(2) Check the sample density at the temperature when the sample is measured.

Here, 0.856 as an example.

(3) Divide the static viscosity by the sample density to obtain the viscosity.

Here, 860 mPa·s is obtained as the viscosity.

$$\begin{aligned} \text{Viscosity} &= \frac{\text{Static viscosity}}{\text{Sample density}} \\ &= \frac{736}{0.856} \cong 860 \text{ mPa}\cdot\text{s} \end{aligned}$$

5-4-2 At Calibration

When calibrating, enter the product of the absolute viscosity value and the density of the standard viscosity fluid used for calibration, as a correction value.

The standard viscosity fluid has the calculation sheet of kinetic viscosity and viscosity at various temperatures attached. To obtain the correction value using this sheet, do as follows:

$$\text{Kinetic viscosity} = \frac{\text{Viscosity}}{\text{Density}} \quad \text{From this, Density} = \frac{\text{Viscosity}}{\text{Kinetic viscosity}} \dots\dots [2]$$

$$\text{Correction value} = \text{Viscosity} \times \text{Density} \dots\dots [3]$$

When substituting [2] for the density in [3], the following equation is obtained.

$$\text{Correction value} = \frac{\text{Viscosity}^2}{\text{Kinetic viscosity}} \dots\dots [4]$$

Example 1: To calibrate the rheometer using a standard viscosity fluid:

Using the calculation sheet, calculate the value used for calibration.

- (1) Check the kinetic viscosity and the viscosity at the temperature when the calibration is performed.

Here, 1011 mm²/s for the kinetic viscosity and 889 mPa·s for the viscosity at 20°C as an example.

- (2) Substitute the values above into equation [4].

$$\frac{889^2}{1011} \cong 781$$

781 mPa·s is obtained as a correction value used for calibration.

- (3) After calibration, measure the viscosity of the standard viscosity fluid used. In this example, a value similar to “781 mPa·s” is confirmed as static viscosity, and calibration then ends.

Example 2: To calibrate using a standard viscosity fluid with known values of viscosity and density.

In this example, a standard viscosity fluid with a viscosity of 889 mPa·s at 20°C is used.

- (1) Check the viscosity value and the density of the standard viscosity fluid at the temperature when the calibration is performed.

Here, 889 mPa·s for the viscosity and 0.878 for the density at 20°C as an example.

- (2) Substitute the values above into equation [3].

$$889 \times 0.878 \cong 781$$

781 mPa·s is obtained as a correction value used for calibration.

- (3) After calibration, measure the viscosity of the standard viscosity fluid used. In this example, a value similar to “781 mPa·s” is confirmed as static viscosity, and calibration then ends.

5-5 About the relation among amplitude value, shear rate and viscosity

When measuring with a non-Newtonian fluid, a viscosity can not be judged without deciding a value for shear rate or shear stress because there is no proportional relation between shear rate and shear stress. When measuring with the RV-10000A, vibration is repeatedly applied to the sample using sine vibration, and viscosity is expressed by converting into an effective value the shear rate that is constantly changing due to vibration.

Refer to the following charts for details of the relation among amplitude value, shear rate and viscosity with the RV-10000A.

The second chart below shows the relation between the viscosity measurement range at each amplitude and shear rate.

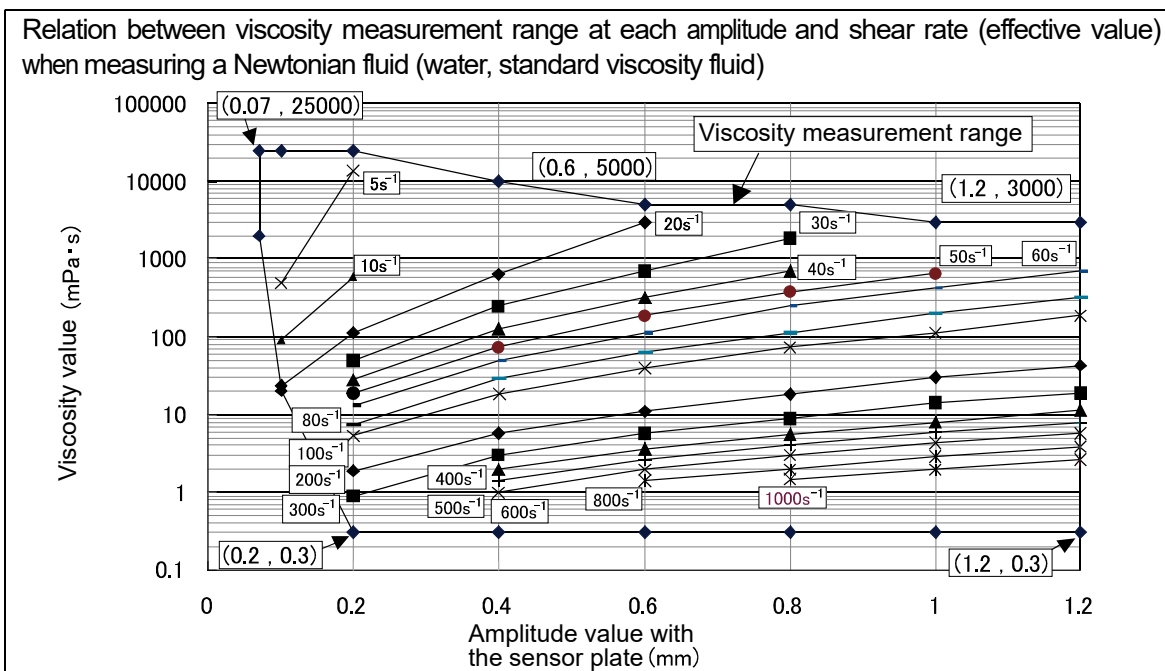
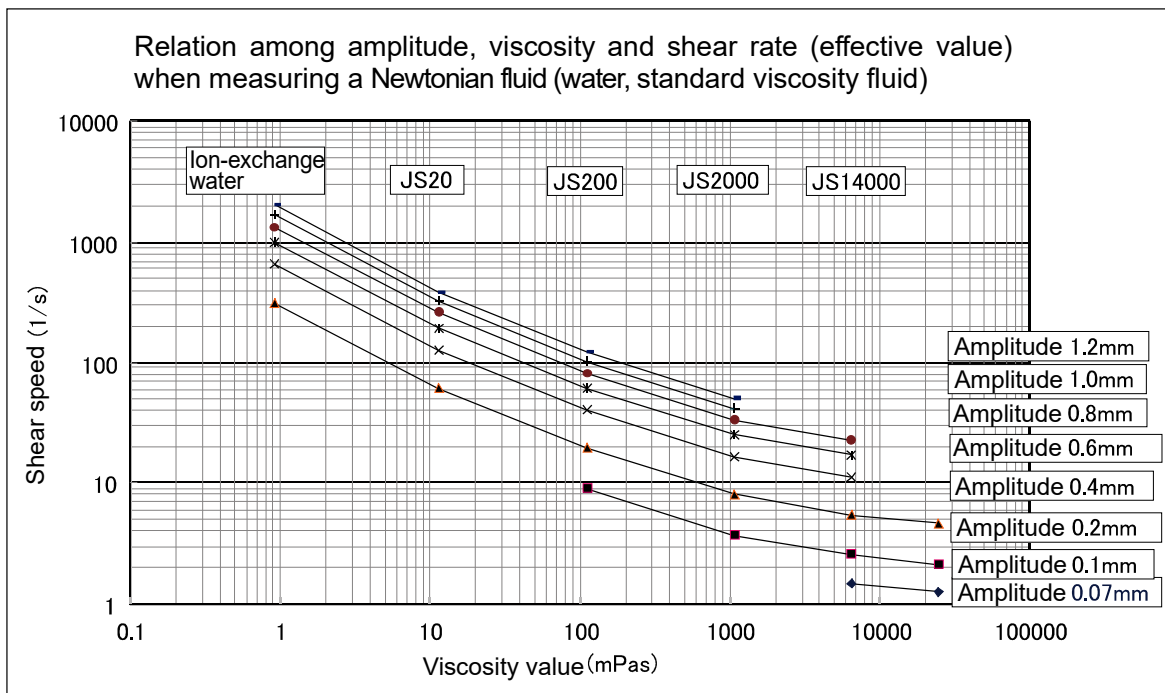

6. MEASUREMENT

6-1 Preparing the Sample

* Vibration or shock during transportation may cause a display value error. Before measurement, calibrate the rheometer using the sample cup that will be used for measurement. For calibration with purified water, refer to “9-2-3 Simplified Calibration Using Purified Water”.

Operation procedure

- 1 Pour the sample into the cup until its surface is between the level gauges.
 - With the 45 mL sample cup, the lower level gauge indicates 35 mL, the upper level gauge indicates 45 mL.
 - The 13 mL glass sample cup does not have level gauges. The position approximately 25 mm above the cup bottom indicates 13 mL.

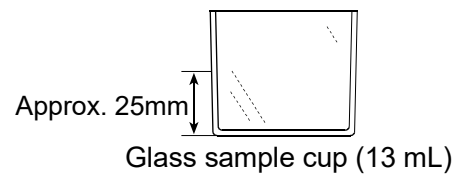
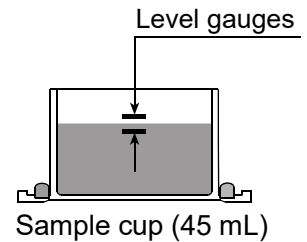

- 2 Attach the cup on the table along the guides.

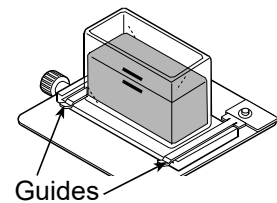

- 3 Confirm that the protector is in the position as shown in the figure. Raise the lever to release the sensor unit.

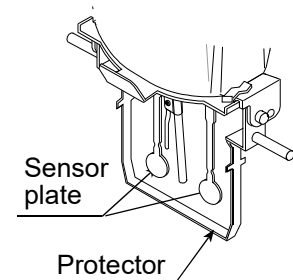

- 4 Pinch the grips, support the front side of the sensor unit and gently lower the sensor plates above the sample surface.

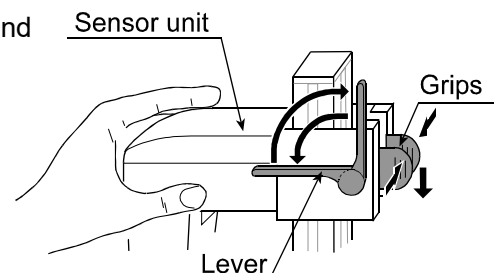

- 5 Lower the lever to secure the sensor unit.

- 6 Confirm that the positioning of the sensor plates is in center of the sample cup by adjusting the X-Y-Z stage.

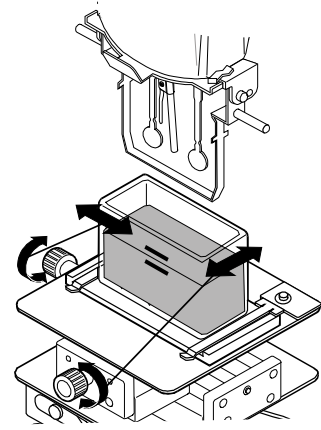

- 7 Turn the knob (Height direction) so as to adjust the sample surface to the center of the narrow part of the sensor plates. At this time, use the surface locator plate as a guide. The surface locator plate has been secured in position so that the tip of the surface locator plate comes into contact with the sample surface.

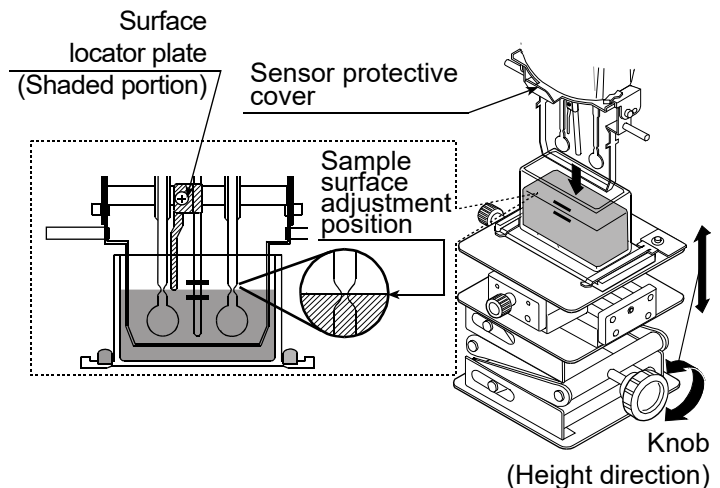

Note

- Adjust the height of the sample surface correctly, otherwise it may cause a measurement error.
- The surface locator plate can be attached or removed by loosening the screw.
- Before removing the sensor protective cover, remove the surface locator plate.
- Removing and reattaching the surface locator plate will cause the position (Height) of the sensor plates and the sample surface to change. Therefore, it is recommended that calibration be performed using a standard viscosity fluid before measurement.

Note

Use the protector in the position as shown on the left below. If the protector is not used, a measurement error may occur, especially in measuring a viscosity over 5000 mPa.s.

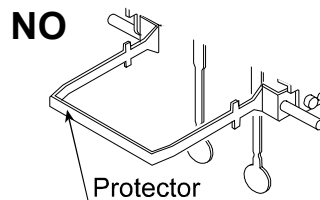
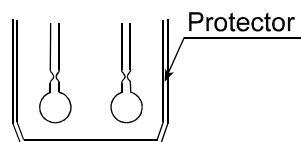

When the position of the sensor plates in the liquid is not at the same level, level the rheometer using the leveling feet so that the liquid surface will be leveled.

6-2 Measurement using the controller (Auto mode)

Turn on the power switch of the controller (I side).

Touch the **Auto mode** button in the Home screen to open the measurement condition setting screen.

6-2-1 Measurement condition setting screen

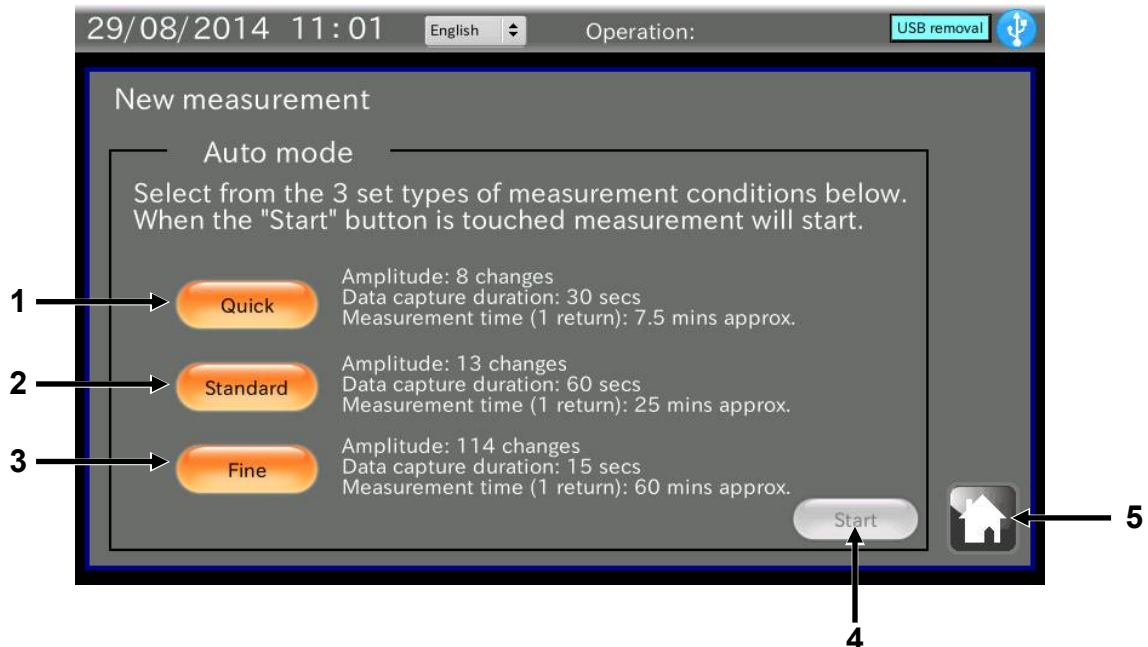

No.	Name	Description
1	Quick button	Measurement to give priority to measurement time. 1 return is the amplitude of 8 steps. (0.07→0.1→0.2→0.4→0.6→0.8→1.0→1.2) (0.07←0.1←0.2←0.4←0.6←0.8←1.0 ←) Amplitude change time: 20 secs + Data acquisition time: 10 secs, Measurement time: 7.5 mins approx.
2	Standard button	The standard measurement. 1 return is the amplitude of 13 steps. (0.07→0.1→0.2→0.3→0.4→0.5→0.6→0.7→0.8→0.9→1.0→1.1→1.2) (0.07←0.1←0.2←0.3←0.4←0.5←0.6←0.7←0.8←0.9←1.0←1.1 ←) Amplitude change time: 20 secs + Data acquisition time: 40 secs, Measurement time: 25 mins approx.
3	Fine button	Fine measurement of amplitude with 0.01mm scales. 1 return is the amplitude of 114 steps. (0.07→0.08→0.09→.....→1.19→1.20) (0.07←0.08←.....←1.18←1.19 ←) Amplitude change time: 10 secs + Data acquisition time: 5 secs, Measurement time: 60 mins approx.
4	Start button	When the measurement mode is selected, the Start button is valid. Starts the measurement.
5	 HOME button	Exits the measurement and returns to the HOME screen.

6-2-2 Measurement screen

Touch the **Start** button to open the measurement screen. The measurement is started, and a graph is displayed.



No.	Name	Description
1	Title	Title of the graph can be entered. (maximum 30 characters)
2	Change axis	Changes the X-axis and the second Y-axis. (Viscosity values are fixed for the first Y-axis.) (1) X-axis: Time Y-axis: Temperature (2) X-axis: Time Y-axis: Shear rate *2 (3) X-axis: Time Y-axis: Amplitude (4) X-axis: Temperature Y-axis: Shear rate *2 (5) X-axis: Temperature Y-axis: Amplitude (6) X-axis: Shear rate Y-axis: Temperature *2 (7) X-axis: Shear rate Y-axis: Amplitude *2 (8) X-axis: Amplitude Y-axis: Temperature (9) X-axis: Amplitude Y-axis: Shear rate *2
3	Save screen button	Saves a screen to a USB memory as a JPEG file. *1, 3
4	CSV output button	Outputs the measurement data to a USB memory as a CSV file. *1
5	End button	Ends the measurement.
6	Return button	Returns to the measurement condition setting screen. *4
7	HOME button	Exits the measurement and returns to the HOME screen.

*1 When a USB memory is not recognized, the button is invalid.

*2 Shear rate is a reference value which is calculated on the assumption that it is a Newtonian fluid. Shear rate is indicated at an effective value.

*3 A file name will be "display_date and time (YYYYMMDDhhmmss)".

*4 When the measurement is not finished, the button is invalid.

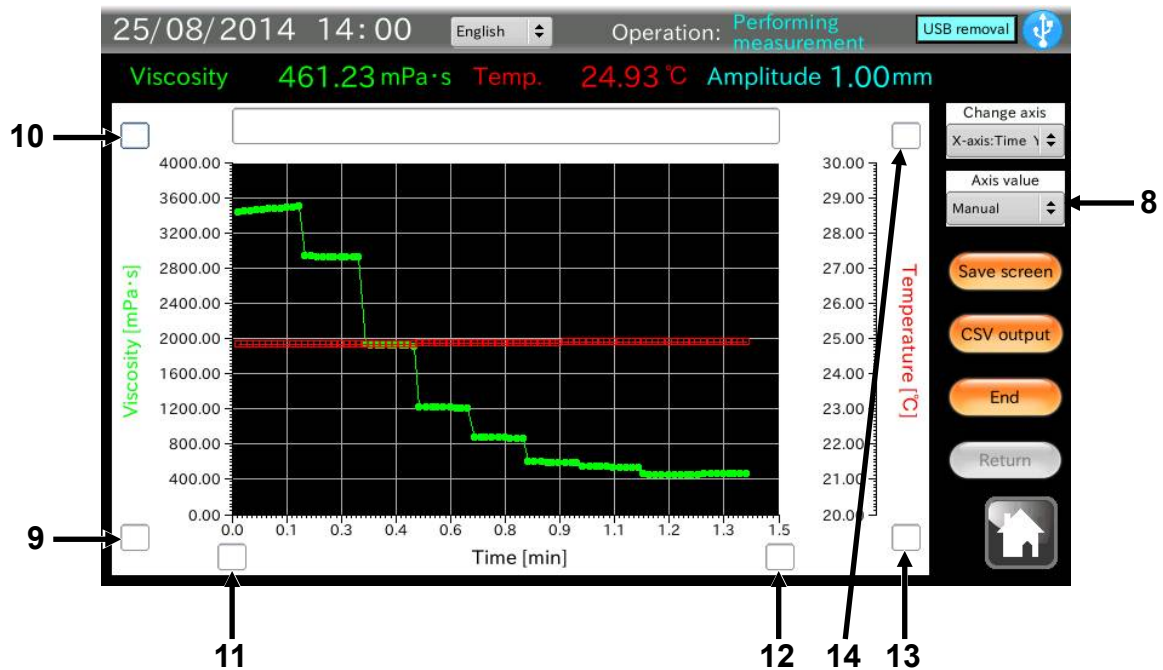

No.	Name	Description
8	Axis value	Select the maximum and minimum values of the graph axis from "Auto" / "Manual".
9	Y-axis minimum value	Enter the minimum value of the Y-axis.
10	Y-axis maximum value	Enter the maximum value of the Y-axis.
11	X-axis minimum value	Enter the minimum value of the X-axis.
12	X-axis maximum value	Enter the maximum value of the X-axis.
13	2nd Y-axis minimum value	Enter the minimum value Y of the second Y-axis.
14	2nd Y-axis maximum value	Enter the maximum value of the second Y-axis.

NOTE: 9 - 14 appears only when "Manual" is selected in 8.

6-2-3 CSV Output

Touch the **CSV output** button in the Measurement screen to open the CSV output screen.

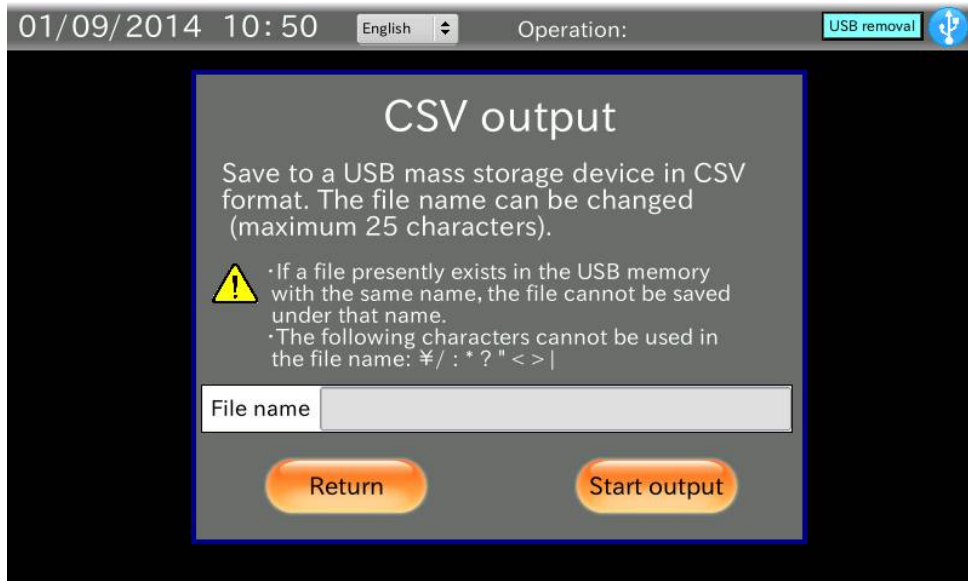

Procedure

- 1 Any file name (maximum 25 characters) can be entered.
When not entered, a file name will be "A&D_RVdata_date and time (YYYYMMDDhhmmss)".
- 2 Confirm that the USB symbol in the upper right corner of the screen is not crossed out with an X and touch the **Start output** button.
- 3 "The CSV file output" is displayed.
While the CSV file is displayed, do not remove the USB memory or do not turn the controller off.
It will take approximately 10 seconds to output a CSV file.

NOTE: If a file presently exists in the USB memory with the same name, the file cannot be saved under that name.

The following characters cannot be used in the file names: ¥ / : * ? " < > |

6-3 Measurement using the controller (Program mode)

Touch **Program mode** button in the Home screen to open the measurement condition setting screen.

6-3-1 Measurement condition setting screen

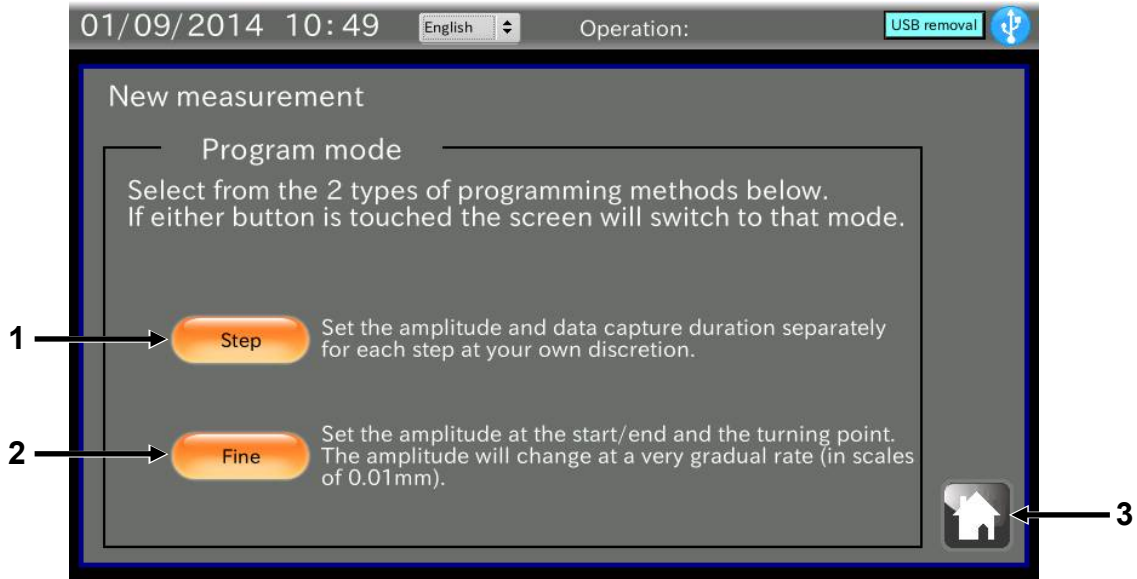

No.	Name	Description
1	Step button	Set the amplitude and data capture duration separately for each step at your own discretion. (up to 100 steps) This is effective when measuring only amplitude of specific.
2	Fine button	Set the amplitude at the start /end and the turning point. The amplitude will change at a very gradual rate (in scales of 0.01mm).
3	HOME button	Exits the measurement and returns to the HOME screen.

6-3-2 Program mode (Step)

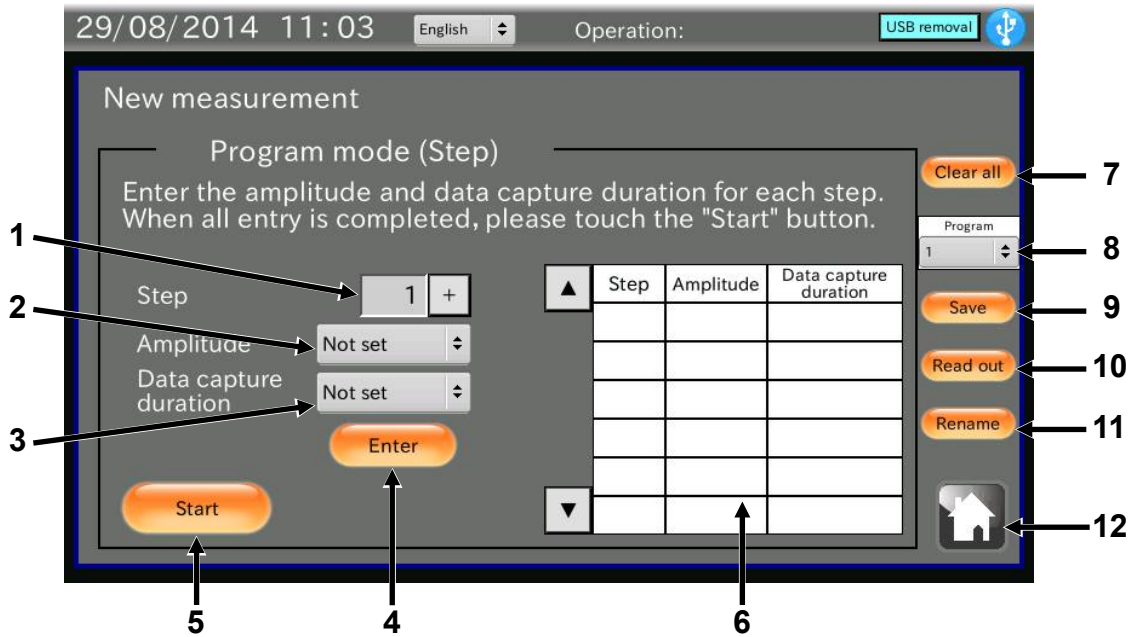



No.	Name	Description
1	Step number	Select the step number to set the amplitude and data capture duration.
2	Amplitude	Select the amplitude value.
3	Data capture duration	Select the data capture duration.
4	Enter button	Sets the amplitude and data capture duration of the step number that was selected.
5	Start button	Starts the measurement by a program that was set.
6	Program list	Displays the programs that was set. It will be blank, when it is not set.
7	Clear all button	Clears all the programs.
8	Program number	Select a program to save, read, change the name.
9	Save button	Saves a program that was set to the selected number in the "8 Program number".
10	Read out button	Reads a program stored to the selected number in the "8 program number" and displays it in the program list.
11	Rename button	Renames the name of a program stored to the selected number in the "8 program number". (Maximum 20 characters)
12	HOME button	Exits the program settings and returns to the HOME screen.

Procedure

- 1 Select the step number to be programmed with , buttons.
- 2 Touch the to select the amplitude value.
- 3 Touch the to select the measurement time.
Time to wait for the stability of the vibration is not included. (Display unit is blinking "-----")
- 4 Touch the button.
A program stored to the controller is displayed in the program list.
- 5 Repeat steps 1 to 4 as necessary.
- 6 Touch the button.
Measurement is started, and the graph screen appears.

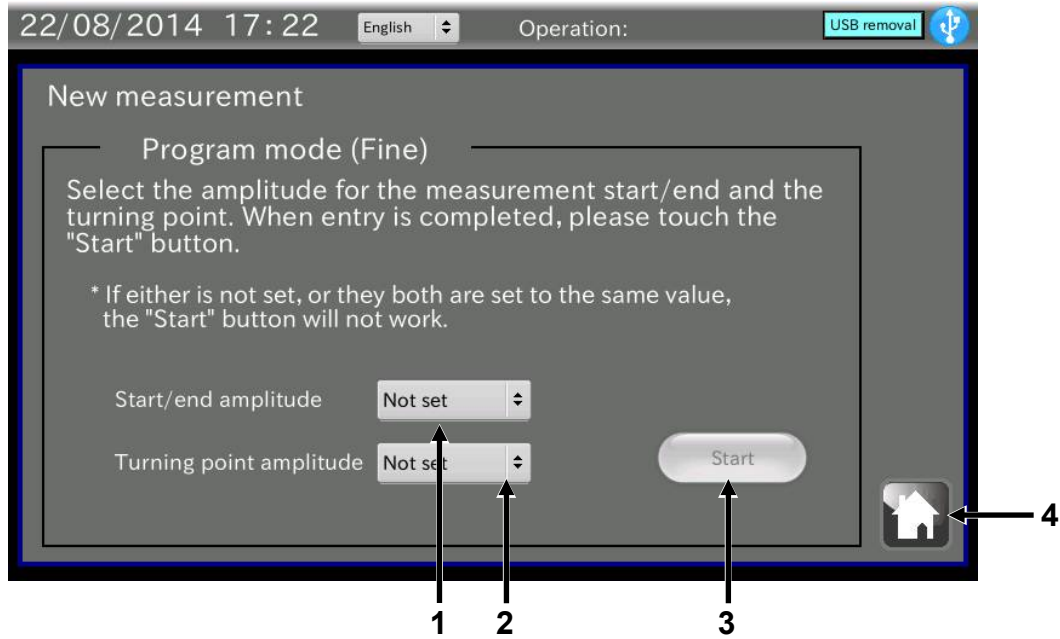
6-3-3 Program mode (Fine)



No.	Name	Description
1	Start/end amplitude	Select the amplitude value of start and end.
2	Turning point amplitude	Select the turning point amplitude value.
3	 Start button	Starts the measurement by a program that was set. If No.1 and 2 is not set, the button is invalid.
4	 HOME button	Exits the program settings and returns to the HOME screen.

Procedure

- 1 Touch the Start/end amplitude to select the amplitude value.
- 2 Touch the Turning point amplitude to select the turning point of amplitude value.
- 3 Touch the Start button.
Measurement is started, and the graph screen appears.
Measurement time is 5 seconds (4 or 5 data), with the exception of time to wait for the stability of the vibration.

About the amplitude change during measurement

Example

Start/end amplitude: 0.6 mm

Turning point amplitude: 0.7 mm

Amplitude will change as follows.

0.60mm → 0.61mm → 0.62mm → . . . → 0.70mm → 0.69mm → . . . → 0.60mm

6-4 Graphing CSV data

Touch **Data selection** button in the Home screen to open the Data selection screen.



Use the CSV data in a USB memory

Procedure

- 1 Connect a USB memory.
- 2 Confirm that the USB memory is recognized and the USB symbol in the upper right corner of the screen is not crossed out with an X. Touch the **Browse...** button.
- 3 A dialog box opens to show a list of files saved in a USB memory.
Touch the CSV file to generate a graph and touch the **OK** button.
NOTE: Files inside the new folders in a USB memory will not appear in the list.
- 4 Touch the **OK** button.
- 5 The selected data is read and the graph is displayed.
It may take about 20 seconds to read data.
Refer to "[6-2-2 Measurement screen](#)" for a graph screen.

6-5 Measurement using only the main unit

When measuring at the display unit of the main unit without using the controller, select an amplitude value from the 8 steps and measure the viscosity.

6-5-1 Setting amplitude value

1. With the power off, press the **ON:OFF** key.

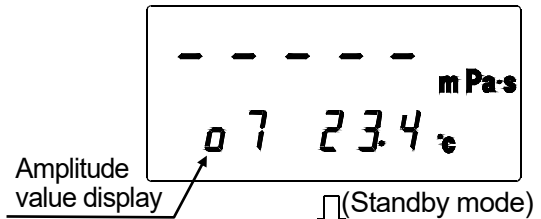
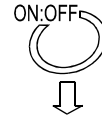

2. Once the display is in standby mode, press the **↑** or **↓** key.

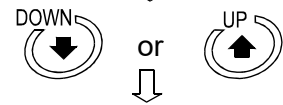

3. The amplitude value display blinks.

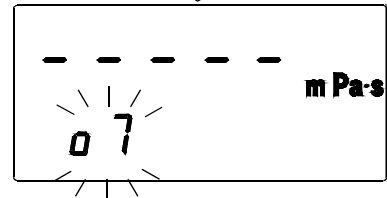

4. By pressing **↑** key, the amplitude value increases.

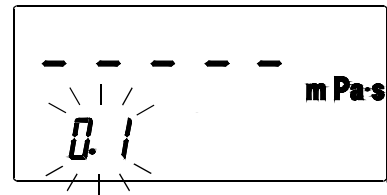

5. By pressing **↓** key, the amplitude value decreases.

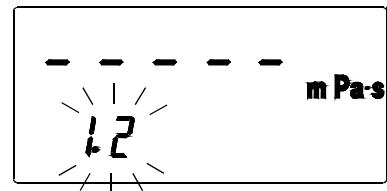

6. Press the **PRINT** key at the desired amplitude value to confirm the amplitude value.
(Even if the **START** key is pressed, the amplitude value will be confirmed. After that, vibration is started.)

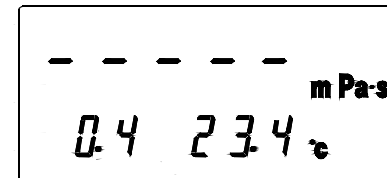
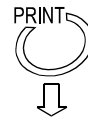

Settable range of amplitude

Amplitude *	Amplitude value display
0.07mm	07
0.1mm	0.1
0.2mm	0.2
0.4mm	0.4
0.6mm	0.6
0.8mm	0.8
1.0mm	1.0
1.2mm	1.2

* The amplitude value is peak to peak (P-P).

6-5-2 Measurement

(1) Starting measurement

Press the **START** key to start vibration. The viscosity value is displayed after approx. 15 seconds. While measurement is being carried out, the processing indicator illuminates.

(After approx. 15 seconds)

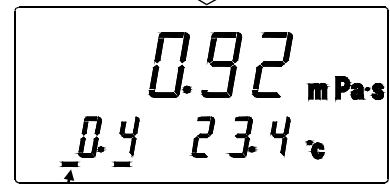

Processing indicator

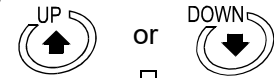

(2) Changing the amplitude during measurement

1. Even while the measurement is being carried out, it is possible to change the amplitude by pressing the **UP** or **DOWN** key.

If the **UP** or **DOWN** key is pressed, the amplitude display blinks.

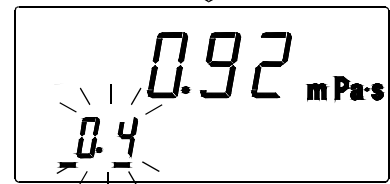

2. By further pressing the **UP** or **DOWN** key, the amplitude value changes.

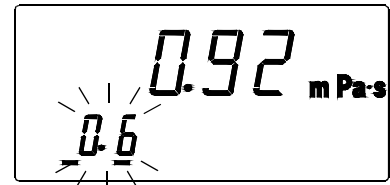

3. Press the **PRINT** key at the desired amplitude value to confirm the amplitude value.

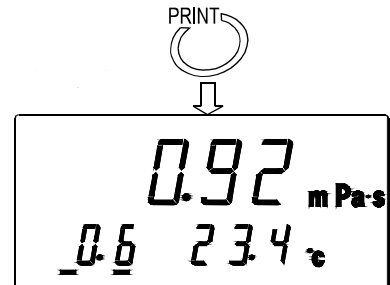

When an amplitude is changed, the bar display blinks.

The amplitude value is displayed after approx. 15 seconds.

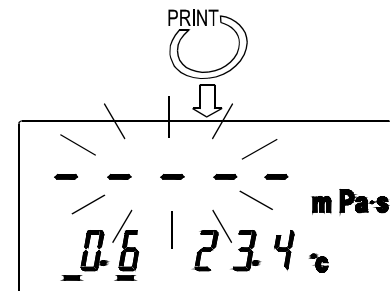

(3) Stopping measurement

Press the **STOP** key to stop the measurement. The viscosity value is held.

(4) Measuring again 1

When measuring again at the amplitude value where the measurement was stopped, press the **START** key without making any changes. The measurement starts at the amplitude value where the measurement was stopped.

(5) Measuring again 2

When measuring with a different amplitude value from the amplitude value where the measurement was stopped, first press the **▲** or **▼** key. The amplitude value display will start to blink. Confirm the change to the amplitude value (Refer to “6-5-1 Setting amplitude value”), and then press the **START** key to start the measurement.

6-5-3 Measurement when using WinCT-Viscosity

It is possible to acquire viscosity or temperature data at each amplitude.

(1) How to use

1. Install WinCT-Viscosity (For details of the installation, refer to Readme in the CD-ROM. WinCT-Viscosity can be used with the RV-10000A in addition to the SV series. When reading contents noted in WinCT-Viscosity, replace “SV” with “RV-10000A”).
2. Start RsVisco in WinCT-Viscosity.

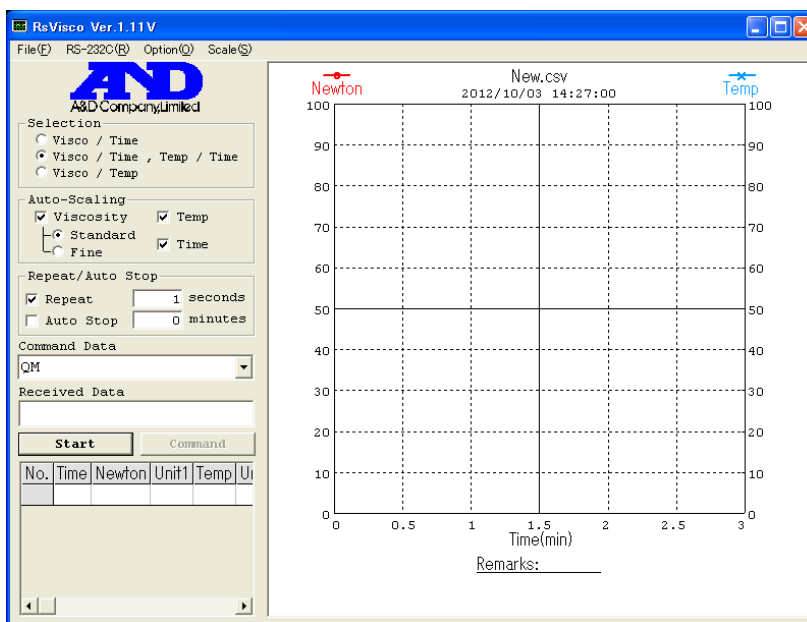

3. Confirm the amplitude value using the RV-10000A. (Refer to “6-5-1 Setting amplitude value“.)
4. Press the **Start** button in RsVisco to start the measurement. Data acquisition starts after approx. 15 seconds.

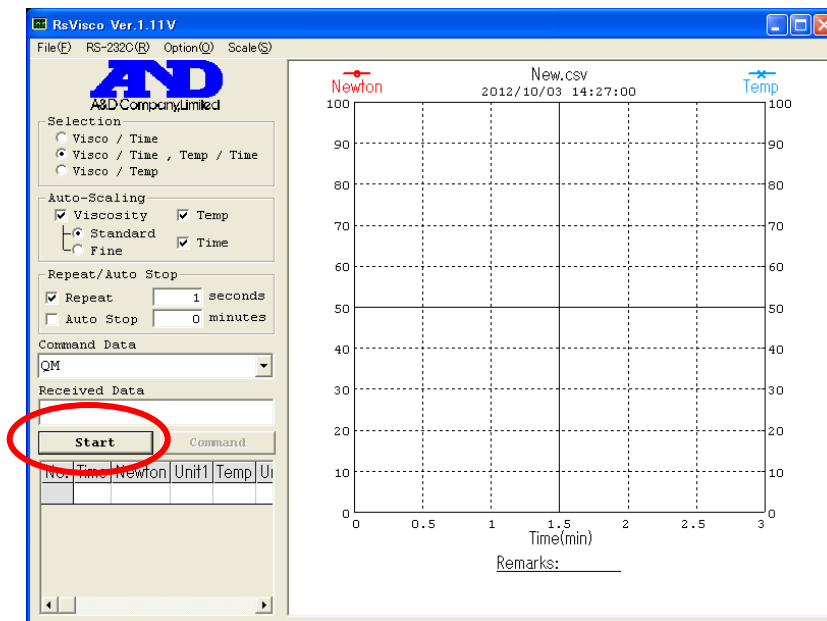

(2) Precautions to be taken when acquiring data with changed amplitude

When acquiring data with changed amplitude, first press the **Stop** button in RsVisco to end the measurement, and then change the amplitude value with the RV-10000A.

1. Press the **Stop** button in RsVisco to end the measurement.

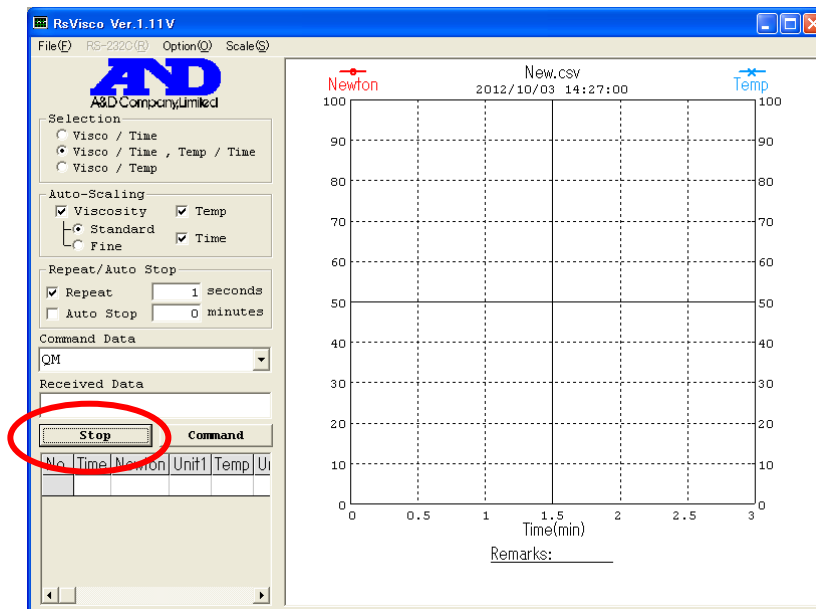

2. Confirm the amplitude value on the RV-10000A. (Refer to “6-5-1 Setting amplitude value“.)
3. Press the **Start** button in RsVisco to start the measurement.

7. USING THE WATER JACKET

7-1 Introduction

The water jacket, is used with the rheometer RV-10000A, to maintain the sample temperature constant or to measure the viscosity when the sample temperature is changed. The operating temperature range is 0°C to 100°C

The water jacket consists of the following:

Water jacket 1 pc (Main body: PC (Polycarbonate), Packing: Silicone rubber, Washer: Nylon)

Screw 1 pc (Screw: POM (Polyacetal), Washer: Nylon)

Refer to pages [93](#) - [94](#) for the AX-SV-37 water jacket.

Note

- As a heating medium, use water, isopropyl alcohol (IPA), mixture of water and IPA, or silicone oil, which does not erode the materials described above. Using the heating medium other than these may damage the water jacket.
- When using the water jacket, make sure that no inner pressure is exerted in the water jacket due to the kinked or blocked tubes, as that could exert the pressure in the water jacket, causing it to break.
- Set the circulation flow rate to 5 L/min or less. Otherwise, the water jacket may be damaged.
- To control the temperature, a commercially available constant temperature bath is required separately.
- The operating temperature range of the disposable cup is 0°C to 80°C.

7-2 Installation

Use the small sample cup (capacity: 10 mL) provided or the glass sample cup (capacity: 13 mL) provided.

To circulate the heating medium into the water jacket, a commercially available constant temperature bath is required.

- 1 Using silicone tubes with an inside diameter of 8 mm, make a connection between the "OUT" connector of the bath and the lower nozzle of the water jacket indicated as **1** in the illustration, and then, between the "IN" connector and the upper nozzle indicated as **2**.

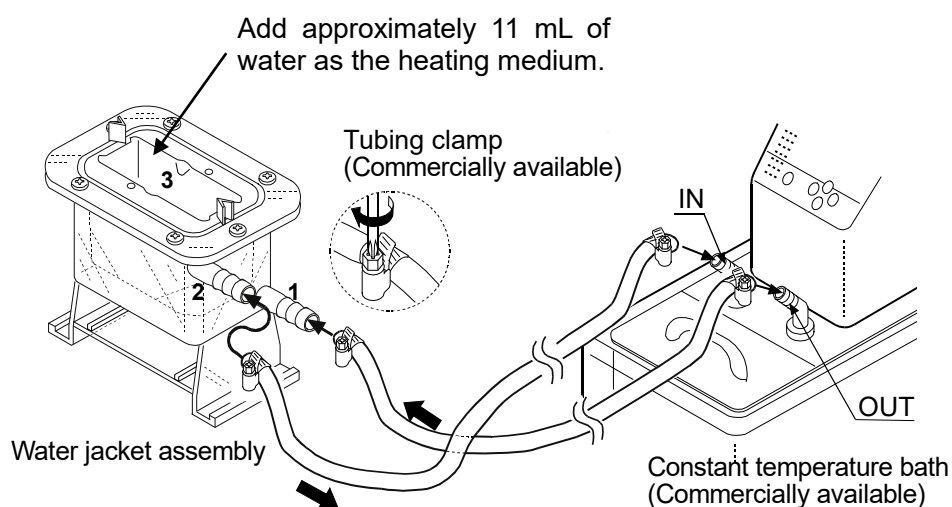

- 2 Pour the heating medium into the water jacket indicated as **3**. An appropriate sample amount is approximately 11 mL.

The heating medium conducts the heat of the water jacket to the sample cup.

Note: When the levels of the sample surface and the heating medium surface are the same and hard to distinguish the positioning of the sensor plates, change the amount of the heating medium.

- 3 Insert the small sample cup into the water jacket indicated as **3**.
When the specific gravity of the sample liquid is small and the small sample cup floats, secure lightly the front side of the cup to the water jacket using the screw provided.
Use the small sample cup cover for volatile samples.

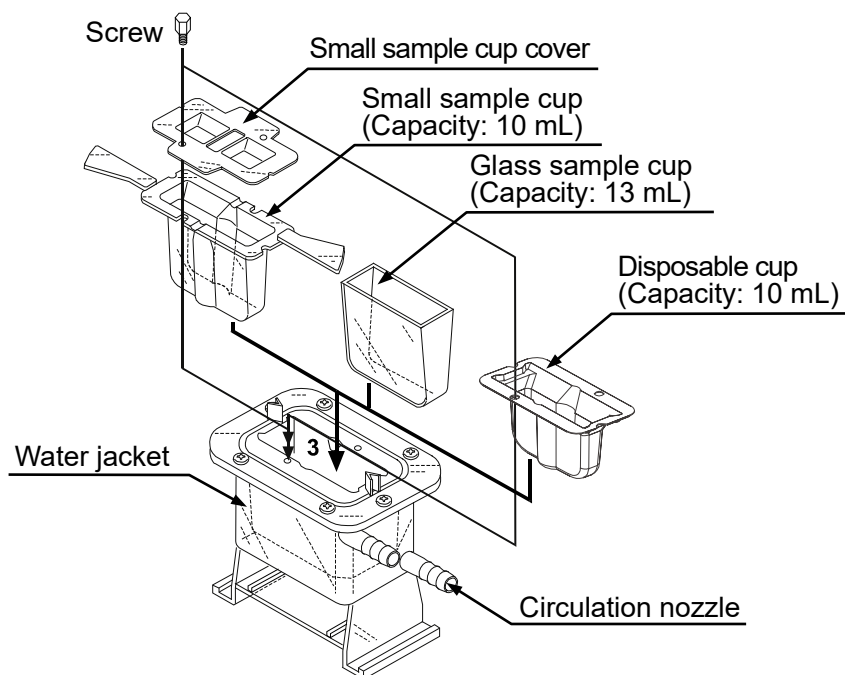

If the handles of the sample cup holder or the small sample cup interfere with the measurement, they can be removed.

Apply force in the up and down directions slowly as shown in the illustration, to break the handle off.

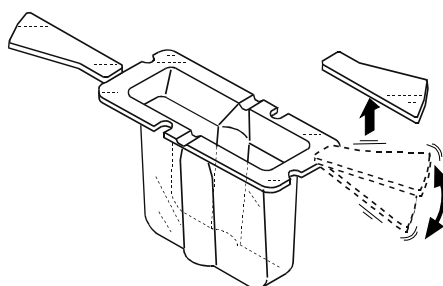

Small sample cup

7-3 How to Use

- 1 Attach the water jacket on the table along the guides. Make sure that the water jacket is slid furthest along the guides until stopped.

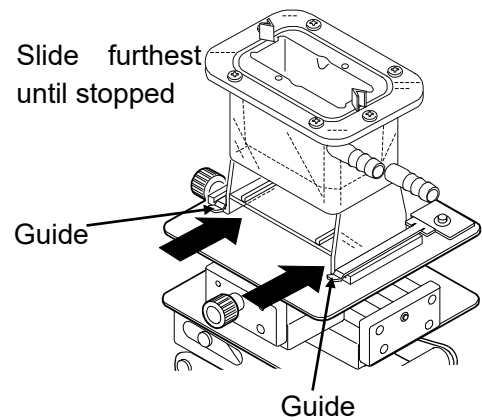

- 2 When the water jacket is used, be sure to raise or remove the protector.

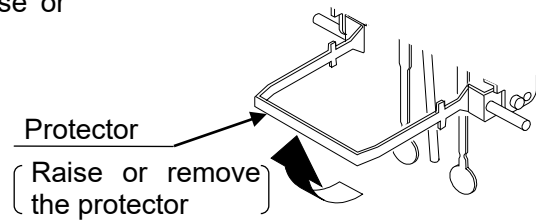

- 3 Use much care so that the sensor plates and the temperature sensor do not come into contact with the inner wall of the sample. If they are in contact, a measurement error may occur.

- 4 Be sure to adjust the sample surface to the center of the narrow part of the sensor plates.

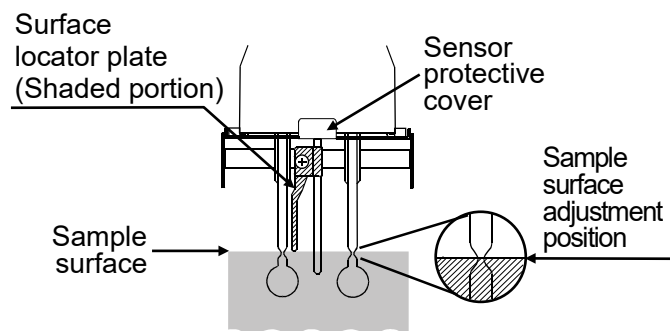

7-4 Measuring the Absolute Value of Viscosity Using the Small Sample Cup

The RV-10000A has been calibrated using the accessory sample cup (45 mL) when shipped. The distance between the inner wall and the sensor plates when the accessory sample cup is used, differs from the distance when the small sample cup (10 mL) is used. This causes a difference in the sensor plate's detection capability, thus causing a difference in the viscosity measured.

Therefore, to measure the absolute value of viscosity using the small sample cup (10 mL), it is recommended that calibration be performed using a fluid with a known viscosity value which is close to the sample viscosity. (Refer to "9. VISCOSITY CALIBRATION" of the rheometer instruction manual.)

7-5 Maintenance

Clean the sample cup as necessary. If cleaning is not sufficient, a measurement error may occur due to contamination.

7-6 Specifications

Operating temperature:	0°C to 100°C
Circulation nozzle outside diameter:	10.5 mm
Recommended hose:	Silicone tube with an inside diameter of 8 mm

- When a stirrer is attached at the bottom of the water jacket, the sample viscosity can be measured while the sample is being stirred. The maximum viscosity value which can be measured is 1000 mPas.

Stirrer: Cimarec™ i Micro Stirrers manufactured by Thermo Fisher Scientific

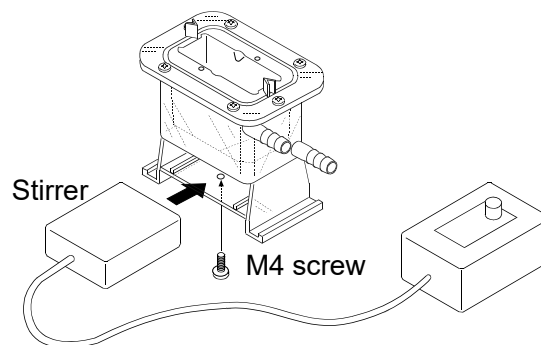

Note

- Use a rotator with a size of 6 mm (length) x 4 mm (diameter).
- Attach the stirrer to the bottom of the water jacket, using an M4 screw from below.
- When the rotator is used, make sure that the rotator will not touch the temperature sensor or the sensor plates. If it does, increase the sample amount so that the rotator will be farther away from the sensor plates.
- Use the stirrer with a revolution speed which will not cause ripples in the sample surface.

8. USING THE DISPOSABLE CUP

8-1 Introduction

The disposable cup is a cup with a capacity of 10 mL to be used in combination with a sample cup (capacity: 35 to 45 mL) or the water jacket. It can be disposed of after use.

The operating temperature range is 0°C to 80°C.

8-2 How to Use

8-2-1. Using with the sample cup (Capacity: 35 to 45 mL)

Place the disposable cup into the sample cup.

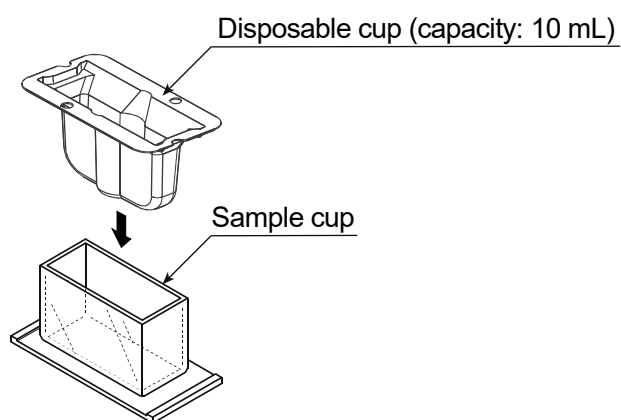

Pour the sample up to the 10 mL line on the disposable cup and measure the viscosity.

8-2-2. Using with the water jacket

Place the disposable cup into the water jacket. Secure the cup to the water jacket using the screw provided with the water jacket.

- When used with the water jacket, in combination with a constant temperature bath for circulating the heating medium, the viscosity can be measured while changing the sample temperature or maintaining it constant.

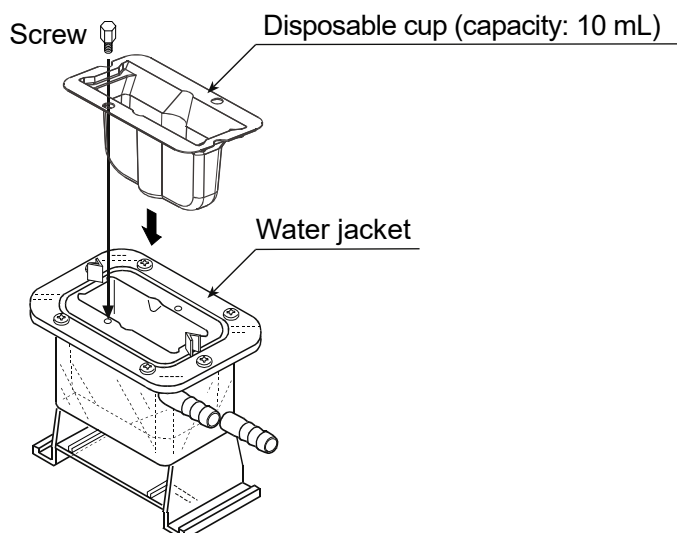

Pour the sample up to the 10 mL line on the disposable cup and measure the viscosity.

8-3 Measuring the Absolute Value of Viscosity Using the Disposable Cup

The RV-10000A has been calibrated using the accessory sample cup (45 mL) when shipped.

The distance between the inner wall and the sensor plates when the accessory sample cup is used, differs from the distance when the disposable cup (10 mL) is used. This causes a difference in the sensor plate's detection capability, thus causing a difference in the viscosity measured.

Therefore, to measure the absolute value of viscosity using the disposable cup (10 mL), it is recommended that calibration be performed using a fluid with a known viscosity value which is close to the sample viscosity. (Refer to "9. VISCOSITY CALIBRATION" of the rheometer instruction manual.)

8-4 Specifications

Capacity	10 mL
Material	Polyethylene terephthalate (PET)
Operating temperature range	0°C to 80°C
Dimensions	67 (W) x 36 (D) x 41 (H) mm
Wall thickness	0.8 mm
Mass	Approx. 3.3 g

9. VISCOSITY CALIBRATION

- Viscosity calibration is to correct the viscosity value.
- Calibration methods are one-point calibration and two-point calibration using desired standard viscosity fluids. It is also possible to carry out simplified calibration using purified water.
- It is recommended that calibration be performed using a fluid with a known viscosity value which is close to the sample viscosity.

When the measuring range is great, perform two-point calibration. Two-point calibration requires two standard viscosity fluids (high viscosity and low viscosity) that are appropriate for the measuring range.

- When measuring the viscosity near 1 mPa·s, simplified calibration using purified water, which is a one-key operation, is available. The RV-10000A has a built-in function to perform an automatic temperature compensation on the viscosity value, based on the temperature of the purified water used.
- In one-point and two-point calibration, the viscosity of a fluid with a known value, such as a standard viscosity fluid, is measured, displayed, corrected digitally and saved in memory.
- To obtain the absolute viscosity value precisely, use the correction value as described in "5-4-2 At Calibration".
- If the wrong calibration data such as a correction value have been entered, the rheometer condition can be restored. For details, refer to "[Initialization \(Err\)](#)" of the main unit function setting.

9-1 Notes on Viscosity Calibration

- Pay close attention to the liquid temperature at calibration. Be sure to enter the temperature corrected viscosity value of the liquid at calibration. Even when using a standard viscosity fluid, temperature change near room temperature causes viscosity change (if increasing the temperature, the viscosity value decreases about 2 to 10 percent per degree Celsius). And even when using purified water, temperature change similarly causes viscosity decrease of about 2 percent per degree Celsius.
- The temperature of the standard viscosity fluid must be the same as the temperature of the sensor plates and the temperature sensor. Allow the displayed temperature to stabilize before calibration.
- Be sure to adjust the sample surface to the center of the narrow part of the sensor plates. Otherwise, a measurement error may occur.
- In the calibration mode, the unit of viscosity is mPa·s. The unit of temperature is fixed to °C.
- Influence caused by the sample cup
The rheometers have been calibrated with the sample cup (Capacity: 45 mL) when shipped. When using another cup, use that cup to measure viscosity only after calibrating with it.

Note

The rheometer has been calibrated with the protector attached when shipped. Please note that the value, obtained when the rheometer is calibrated without the protector, may be different from that upon shipment.

- If purified water (such as pressurized tap water) is used for simplified calibration, or the water temperature is different from the ambient temperature, bubbles may accumulate on the sensor plates and cause a measurement error. Remove any accumulated bubbles before calibration.
- If the measured viscosity of the purified water is 3.00 mPa·s or greater, it is contaminated and simplified calibration can not be performed using it. Replace the water.

9-2 Calibration Procedure

Note

As to the correction value used for one-point calibration and two-point calibration, enter the product of the absolute viscosity value and the density of the standard viscosity fluid. For details, refer to "[5-4-2 At Calibration](#)".

After calibration, check the values, comparing the product described above with the displayed value.

$$\text{Kinetic viscosity} = \frac{\text{Viscosity}}{\text{Density}} \quad \text{From this, Viscosity} \times \text{Density} = \frac{\text{Viscosity}^2}{\text{Kinetic viscosity}} \quad \text{is obtained.}$$

Example 1: To calibrate the rheometer using a standard viscosity fluid:

Using the calculation sheet, calculate the value used for calibration.

- (1) Check the kinetic viscosity and the viscosity at the temperature when the calibration is performed.

Here, 1011 mm²/s for the kinetic viscosity and 889 mPa·s for the viscosity at 20°C as an example.

- (2) Substitute the values above to obtain the value for $\frac{\text{Viscosity}^2}{\text{Kinetic viscosity}}$.

$$\frac{889^2}{1011} \cong 781$$

781 mPa·s is obtained as a correction value used for calibration.

Example 2: To calibrate using a standard viscosity fluid with known values of viscosity and density.

In this example, a standard viscosity fluid with a viscosity of 889 mPa·s at 20°C is used.

- (1) Check the viscosity value and the density of the standard viscosity fluid at the temperature when the calibration is performed.

Here, 889 mPa·s for the viscosity and 0.878 for the density at 20°C as an example.

- (2) Substitute the values above to obtain the value for Viscosity × Density.

$$889 \times 0.878 \cong 781$$

781 mPa·s is obtained as a correction value used for calibration.

9-2-1 One-point Calibration

1 In the standby mode, press and hold the  key to enter the calibration mode. "CAL" appears.

2 Select one-point calibration (CAL-1) and press the  key to confirm. The standby mode of the one- calibration mode appears.



Use the  key to switch between the calibration modes, one-point calibration (CAL-1) or two-point calibration (CAL-2).

* Press the  key to exit the calibration mode. The display returns to the standby mode.

3 Place the standard viscosity fluid in the sample cup. Press the  key to start a measurement.

4 After the measurement, wait for the display to become stable and press the  key. The measurement value blinks and is ready to be corrected.

5 Correct the value using the following keys:

-  key Switches the blinking digits.
-  key Changes the setting of a blinking digit.
-  key Moves the decimal point.

6 Press the  key to confirm the correction value.

7 To exit the calibration mode:

With "End" being displayed, press the  key again to return to the standby mode.





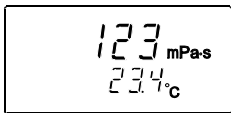

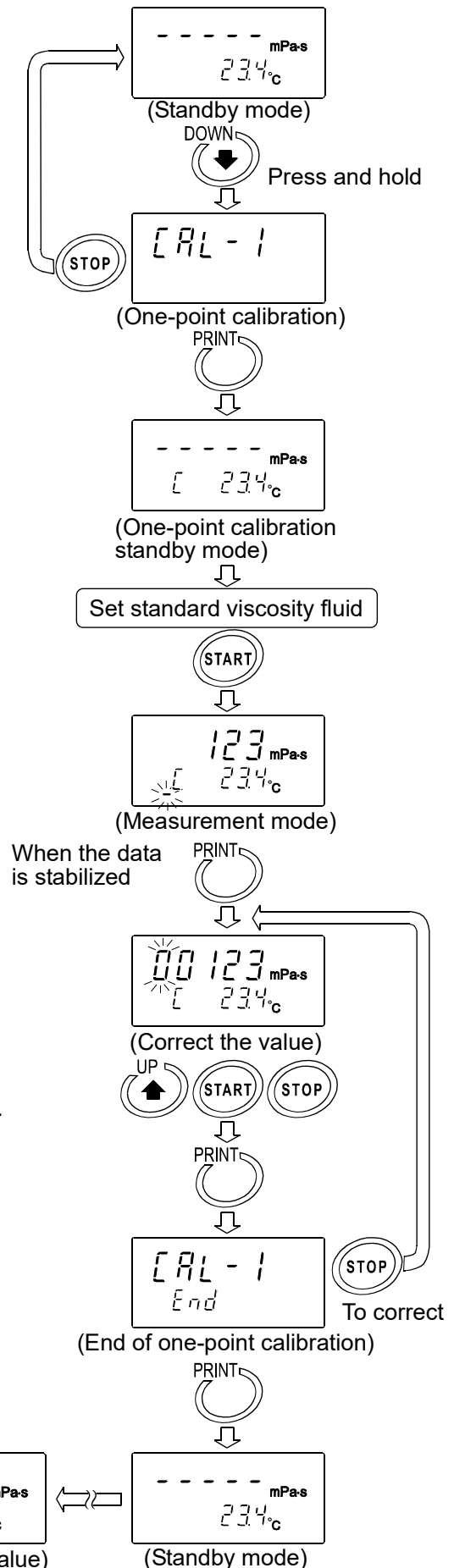





(To correct the value:
With "End" being displayed, press the  key and correct the value.)

8 Measure the viscosity of the standard viscosity fluid used. Confirm that the rheometer displays the similar value as the entered correction value.

(Confirm the value)



9-2-2 Two-point Calibration

- 1 In the standby mode, press and hold the  key to enter the calibration mode. "CAL" appears.
- 2 Select two-point calibration (CAL-2) and press the  key to confirm. The standby mode of the two-point calibration mode appears. Use the  key to switch between the calibration modes, one-point calibration (CAL-1) or two-point calibration (CAL-2).
* Press the  key to exit the calibration mode. The display returns to the standby mode.
- 3 Press the  key to put the display in the standby mode. In two-point calibration mode, the calibration mode ID indicator (-) appears below the temperature display.
- 4 Place the standard viscosity fluid in the sample cup. Press the  key to start the measurement of the first point.
- 5 After the measurement, wait for the display to become stable and press the  key. The measurement value blinks and is ready to be corrected.
- 6 Correct the value using the following keys:
 key Switches the blinking digits.
 key Changes the setting of a blinking digit.
 key Moves the decimal point.
- 7 Press the  key to confirm the correction value.
- 8 To correct the value:
 In the calibration standby mode to enter the second point, press the  key and correct the value.

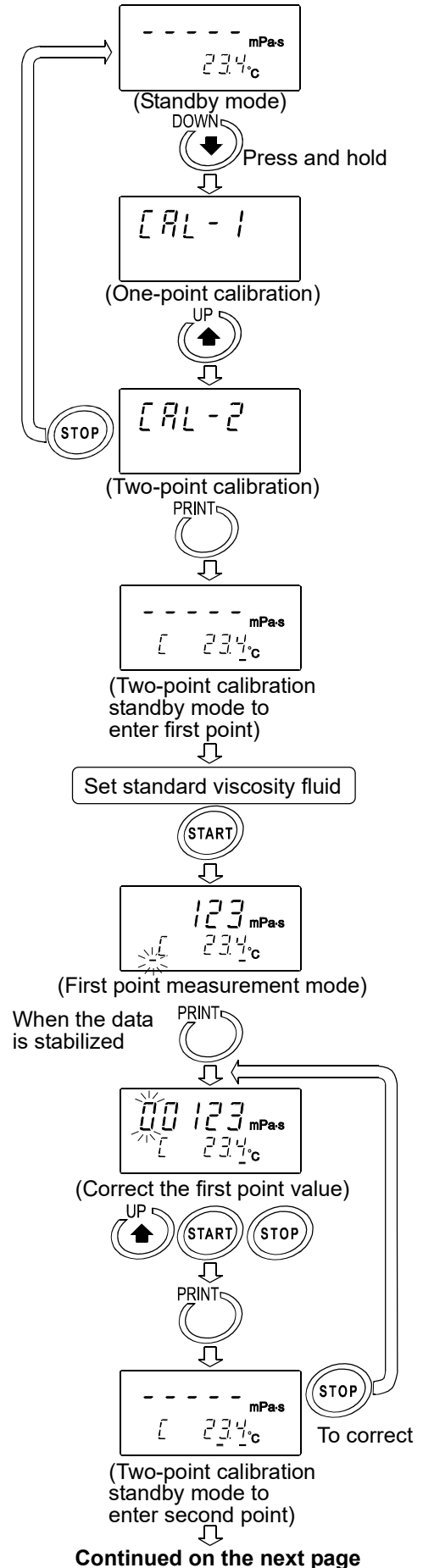

9 When the measurement of the first point has completed, clean the sensor plates, temperature sensor and protector and prepare the second standard viscosity fluid.

10 Place the second standard viscosity fluid in the sample cup. Press the **START** key to start the measurement of the second point.

11 After the measurement, wait for the display to become stable and press the **PRINT** key. The measurement value blinks and is ready to be corrected.

12 Correct the value using the following keys:

- UP** key Switches the blinking digits.
- START** key Changes the setting of a blinking digit.
- STOP** key Moves the decimal point.

13 Press the **PRINT** key to confirm the correction value.

14 To exit the calibration mode:

With "End" being displayed, press the **PRINT** key again. The calibration data is saved and the display returns to the standby mode.

To correct the value:
 With "End" being displayed, press the **STOP** key and correct the value.

15 Measure the viscosity of the two standard viscosity fluids used. Confirm that the rheometer displays the similar value as the entered correction value for each fluid.

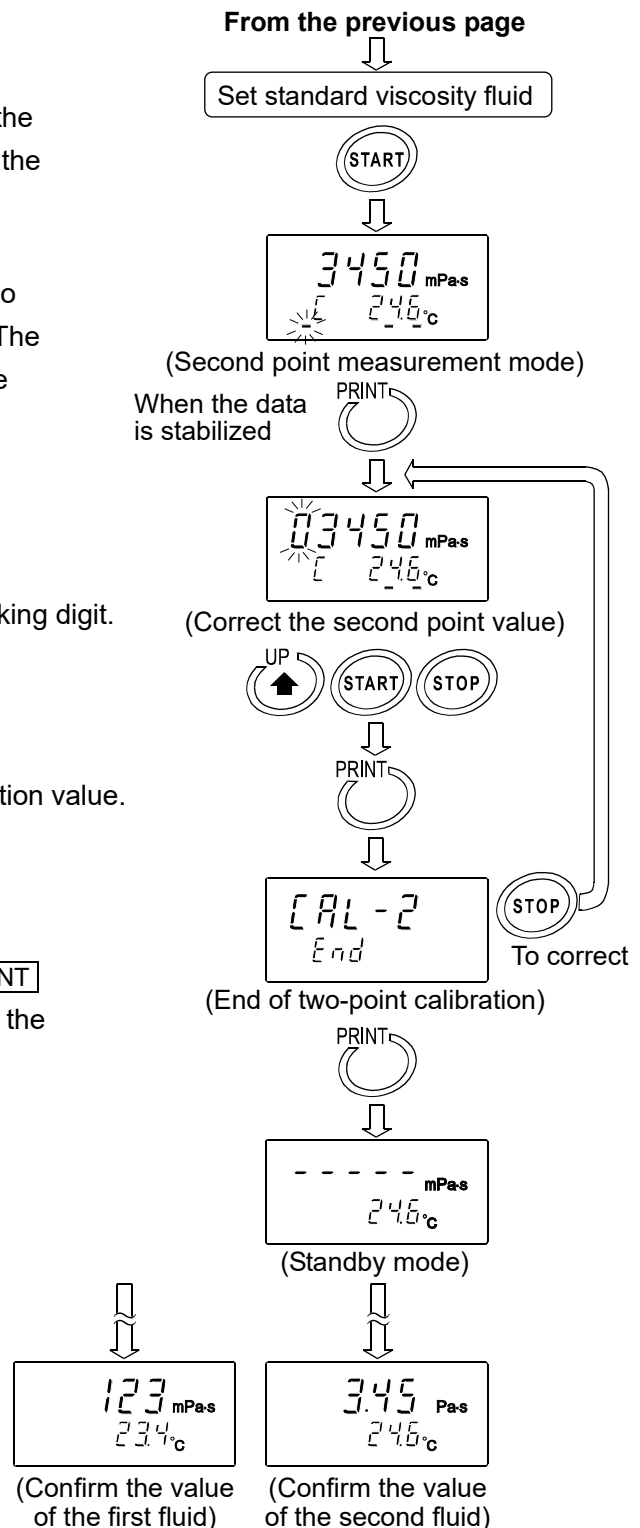

9-2-3 Simplified Calibration Using Purified Water

- 1 Place the purified water in the sample cup.
- 2 Press the **START** key to measure the purified water. Confirm that the viscosity and temperature values are stabilized.
- 3 Press and hold the **START** key. The theoretical viscosity value (Viscosity × Density) of the purified water at the measuring temperature is displayed and all the displays blink.

To cancel the operation, press the **STOP** key. The display returns to the status before calibration.

- 4 Press the **START** key again to perform calibration. When calibration is completed, "End" is displayed. Then, the viscosity returns to the measuring status.

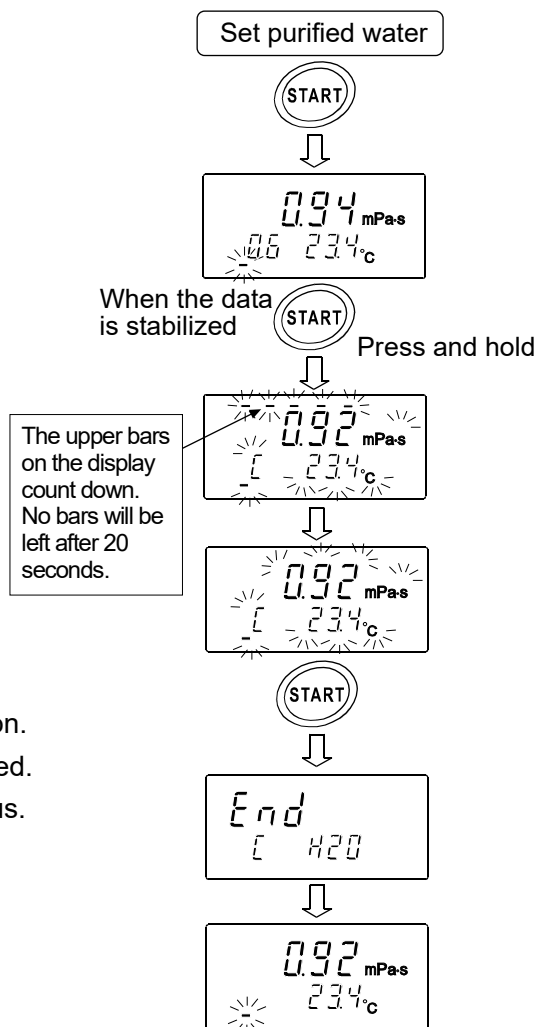

Reference data: Theoretical viscosity value (Viscosity × Density)
of the purified water at various temperatures

Temperature (°C)	Viscosity × Density (mPa·s)
10.0	1.31
11.0	1.27
12.0	1.24
13.0	1.20
14.0	1.17
15.0	1.14
16.0	1.11
17.0	1.08
18.0	1.05
19.0	1.03
20.0	1.00
21.0	0.98
22.0	0.95
23.0	0.93
24.0	0.91
25.0	0.89
26.0	0.87
27.0	0.85
28.0	0.83
29.0	0.81
30.0	0.79

Note

- When tap water is poured into the sample cup directly and is measured, bubbles are generated on the sensor plates due to the difference in pressure and temperature and the viscosity may increase gradually. Pressurized tap water generates bubbles easily. Therefore, use distilled or purified water that is not pressurized. Leave the sensor plates and sample in the same environment to acclimatize before measuring, to decrease temperatures fluctuations.
- In a measurement that takes a long time, the sample viscosity may increase due to water contamination. Perform a periodic check on water quality.

10. MAIN UNIT FUNCTION SETTING











The rheometer, by selecting functions to be used in the function setting, can specify the performance appropriate to the usage.

Each function is assigned parameters. The performance of a function is specified by changing the parameter.

The parameters saved, even if the power is turned off, are maintained in non-volatile memory.

10-1 Operation

The operational procedure of the function setting is as follows:

- 1 In the standby mode, press and hold the  key for at least 2 seconds to enter the function setting mode.
- 2 Press the  key to select a function item.
- 3 Press the  key to confirm the function item. The changeable digit blinks.
- 4 Press the  key or  key to change the blinking digit.
 key Increases the value of the blinking digit. When the value reaches the upper limit of the setting range, the minimum value appears again.
 key Decreases the value of the blinking digit. When the value reaches the lower limit of the setting range, the maximum value appears again.
- 5 To save the new setting, press the  key. After "End", the next item is displayed.
To cancel the new setting, press the  key. The next item is displayed.
- 6 To change other settings, repeat the procedure starting at step 2.
- 7 To exit the function setting mode, press the  key. The rheometer returns to the standby mode.

Note

The operational procedures for setting the date and time ("*LRdJ*"), ID number ("*id*") and initialization ("*LR*") are not the same as the procedure described above. Refer to "[10-3 Description of Items](#)".

"Date/Time" pages [63 - 65](#)

"ID Number Output" page [61](#)



Example of the function setting procedure

To change the setting of "Unit upon power-on (*Unit*)" to the viscosity: cP (Centipoise) and the temperature: °C (Celsius).

- 1 In the standby mode, press and hold the  key to enter the function setting mode. "CLAdJ" appears.

- 2 Press the  key to select "Unit".

- 3 Press the  key to confirm the item.
(The decimal point illuminates when the setting currently saved is displayed.)

- 4 Press the  key or  key to select the unit to be used.
(In this example, "2" is selected. Viscosity: cP, Temperature: °C)

- 5 Press the  key to save the setting.
After "End", the next item is displayed.

- 6 Press the  key to return to the standby mode.

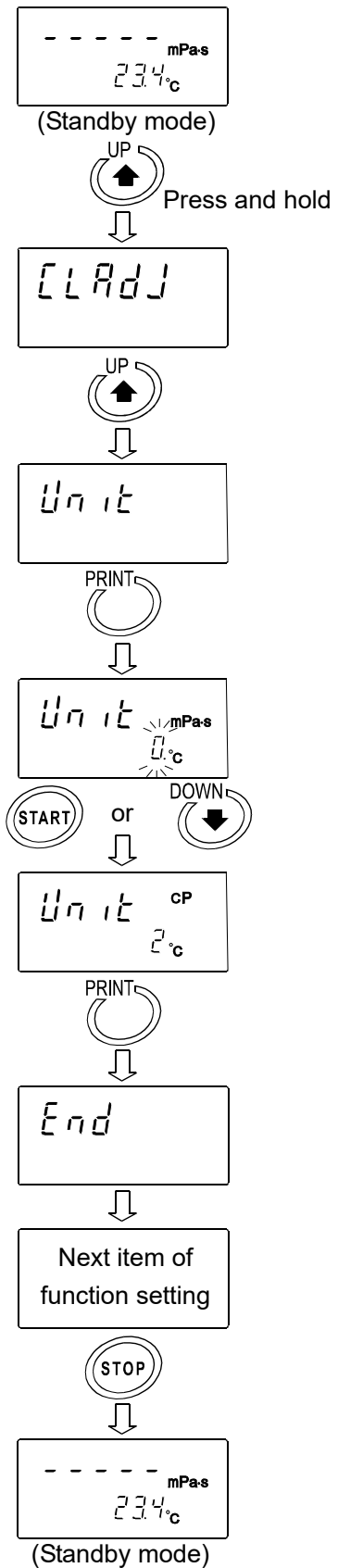

10-2 Details of the Function Items

Function item	Parameter	Description			
<i>CLPdu</i> Date/Time		Sets the order of the date (YMD,MDY,DMY) and the date/time.			
<i>Cond</i> Condition	0	Follows the viscosity changes quickly. (Prone to vibration)			
	1 •	↓			
	2				
<i>Unit</i> Unit upon power-on	0 •	Viscosity	MpPa	Temperature	°C
	1		Pa		
	2		CcP		
	3		P		
	4		mPa		
	5		Pa		
	6		ccP		
	7		P		
<i>Pnt</i> Decimal point	0 •	Dot			With "Comma" selected, the separator for CSV format will be ";" (semicolon).
	1	Comma			
<i>Prt</i> Data output mode	0 •	Key mode			Press the PRINT key to output data.
	1	Auto print mode			Outputs automatically when the STOP key ends the measurement.
	2	Stream mode			Continuous output during measurement. Outputs the viscosity only when D.P. format is selected.
<i>TYPE</i> Data output format	0	A&D standard format			For AD-8121B MODES 1&2
	1 •	D.P. format			For AD-8121B MODE 3
	2	CSV format			For a personal computer
	3	RsVisco format			For graphing program RsVisco
<i>S-Rt</i> Measurement elapsed time output	0	No output			Available only for D.P. format
	1 •	Output			
<i>S-td</i> Date/time output	0	No output			Available only for D.P. and CSV formats
	1 •	Output			
<i>S-Ed</i> Other output	0	No output			Available only for D.P. format
	1	Outputs remarks.			
	2 •	Outputs remarks, Device ID information and signature.			
	3	Outputs ID number.			Available only for CSV format
<i>PUSE</i> Pause at data output	0	No pause			
	1 •	Pause (Approx. 2 seconds)			
<i>ErFnc</i> Reserved	0 •	Usually use this parameter.			
	1				
	7				
<i>id</i> ID number output		Sets the ID number output			By setting "S-Ed", the ID number output can be added to measurement data
<i>CLr</i> Initialization		Restores the function settings and calibration data to the factory setting.			

- Factory setting

10-3 Description of Items

Condition (Cond)

The stability of the viscosity measurement results can be adjusted, taking ambient conditions such as vibration into consideration.

Parameter	Settings	Description
0	Follows the viscosity changes quickly. (Prone to vibration)	When the viscosity value is unstable due to external vibration, set a greater parameter. To measure while following the rapid changes in viscosity, set a smaller parameter. With a smaller setting, the measurement is prone to external vibration. Consider the ambient conditions of the installation site.
1	↓	
2	Follows the viscosity changes slowly. (Stable values)	

Unit Upon Power-on (Unit)

The units of viscosity and temperature displayed when the power is turned on are specified.

Parameter	Settings		Description	
0	Viscosity	mmPa·s (Millipascal second)	Temperature	*1
1		Pa·s (Pascal second)		
2		ccP (Centipoise)		
3		P (Poise)		
4		mPa·s (Millipascal second)		
5		Pa·s (Pascal second)		
6		ccP (Centipoise)		
7		P (Poise)		
			°C (Celsius)	
			°F (Fahrenheit)	

*1 For the viscosity over 1000mPa·s, the unit is fixed to Pa·s. For the viscosity over 1000cP, the unit is fixed to P.

Decimal Point (Point)

Parameter	Settings	Description
0	Dot "."	The decimal point format for the displayed measurement data and the decimal point code for measurement data output via RS-232C are specified. With "Comma" selected, the separator for CSV format and RsVisco format will be ";" (semicolon).
1	Comma ","	

Data Output Mode (P_{rL})

The condition to output the measurement data via RS-232C is set.

Parameter	Settings	Description
0	• Key mode	During measurement or in the data hold mode, pressing the PRINT key outputs the current measurement values.
1	Auto print mode	The measurement values are output automatically when the STOP key ends the measurement. Pressing the PRINT key outputs the measurement values again.
2	Stream mode	The measurement values are output continuously during measurement. When D.P. format is selected in "Output format ($tYPE$)" of the function setting, only the viscosity value is output, regardless of the settings of " $S-Rt$ ", " $S-t_d$ " and " $S-E_d$ ". When this mode is selected, the data hold mode using the HOLD key is not available.

Data Output Format ($tYPE$)

The output format appropriate for the device connected to RS-232C can be selected.

Parameter	Settings	Description
0	A&D standard format	Used with the printer MODE 1 or MODE 2 when the optional compact printer AD-8121B is connected. Only the viscosity value is output.
1	• D.P. format	Used with the printer MODE 3 when the optional compact printer AD-8121B is connected. With " P_{rL} 0" or " P_{rL} 1" selected for "Data output mode (P_{rL})", output contents can be selected by the settings of " $S-Rt$ ", " $S-t_d$ " and " $S-E_d$ ". With " P_{rL} 2" selected for "Data output mode (P_{rL})", only the viscosity value is output.
2	CSV format	Appropriate when a personal computer is used to collect data. Measurement values are output in comma separated format. With " $S-t_d$ " and " i_d " settings, the date/time and ID number can be added to the measurement data. When a comma is selected as the decimal point by " P_{rL} 1", a semicolon ";" is used as a data separator. The viscosity value and the temperature are output using the internal resolution. *2
3	RsVisco format	Used with the graphing program RsVisco. When a measurement is started using RsVisco, the rheometer automatically selects this format. The viscosity value and the temperature are output using the internal resolution. *2

*2 The relation between the measuring unit and the internal resolution is as follows:

	Viscosity				Temperature	
	mmPa·s	Pa·s	ccP	P	°C	°F
Internal resolution	0.01	0.0001	0.01	0.0001	0.01	0.01
	–	0.01	–	0.1		

Measurement Elapsed Time Output (5-RE)

Parameter	Settings	Description
0	No output	With D.P. format selected, whether or not to add the measurement elapsed time (the time elapsed from a measurement start) to the measurement data can be selected. For examples of output format, refer to " 10-4 Data Output Format Examples ".
1	• Output	

Date/time Output (5-td)

Parameter	Settings	Description
0	No output	With D.P. format or CSV format selected, whether or not to add the date and time to the measurement data can be selected. For examples of output format, refer to " 10-4 Data Output Format Examples ".
1	• Output	

Other Output (5-Ed)

Parameter	Settings	Description
0	No output	With D.P. format selected, whether or not to add remarks, Device ID information or signature to the measurement data can be selected. For examples of output format, refer to " 10-4 Data Output Format Examples ".
1	Outputs remarks.	
2	• Outputs remarks, Device ID information and signature.	
3	Outputs ID number.	With CSV format selected, whether or not to add ID number to the measurement data can be selected. For examples of output format, refer to " 10-4 Data Output Format Examples ".

Pause at Data Output (PUSE)

Parameter	Settings	Description
0	No pause	Whether or not to take a pause of two seconds each time one line is output can be selected, when the data are output via RS-232C. When MODE 3 of the optional compact printer AD-8121B is used, select "1".
1	• Pause (Approx. 2 seconds)	

ID Number Output (*id*)









- The ID number is used to identify the rheometer.
- Whether or not to add the ID number to the measurement data can be selected by "S-Ed" of the function setting.
- The ID number is six characters long. The following characters are available for the ID number.

Character	0	1	2	3	4	5	6	7	8	9	(Space)	-(hyphen)	A	B	C	D	E
Display	0	1	2	3	4	5	6	7	8	9	(Space)	-	A	b	C	d	E

Character	F	G	H	I	J	K	L	M	N	O	P	Q	R	S	T	U	V	W	X	Y	Z	
Display	F	G	H	,	J	U	L	n	n	o	P	q	r	S	t	U	u	v	W	X	Y	Z

For examples of output format, refer to "10-4 Data Output Format Examples".

Setting the ID number

- In the standby mode, press and hold the  key to enter the function setting mode. "CLAdd" appears.
- Press the  key to select " *id* ".
- Press the  key to enter the ID number setting mode.
- Set the ID number using the following keys:
 -  key Switches the blinking digits.
 -  key Increases the value of the blinking digit by one.
 -  key Decreases the value of the blinking digit by one.
 -  key Cancel the operation.
- Press the  key to save the setting. After "End ", the next item is displayed.
- Press the  key to return to the standby mode.

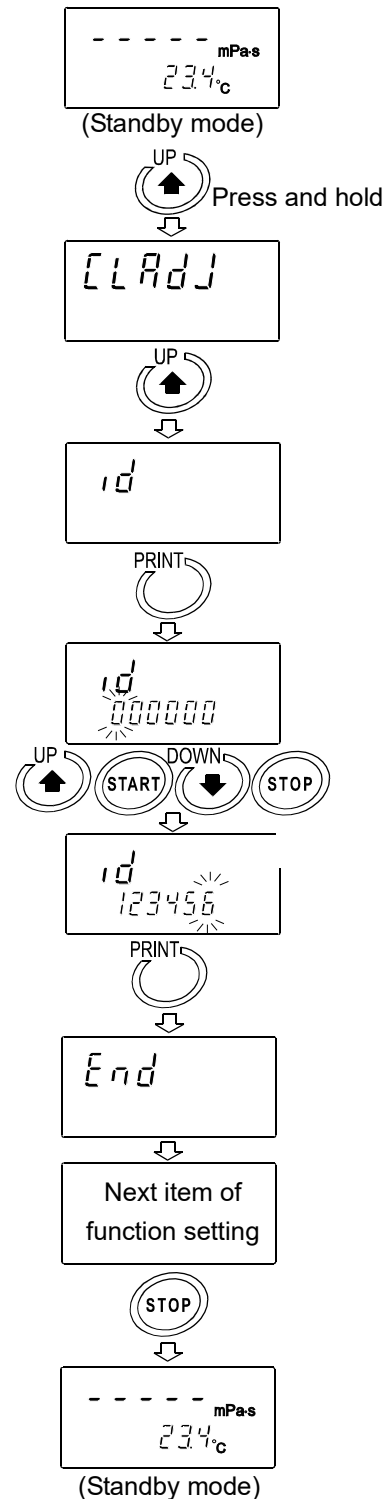







Initialization (ELr)

Restores the following data to the default setting.

- Function setting
- Calibration data

After initialization, check the viscosity value and perform calibration as necessary. (Refer to "9. VISCOSITY CALIBRATION").

- 1 In the standby mode, press and hold the  key to enter the function setting mode. "ELAdd" appears.
- 2 Press the  key to select "ELr".
- 3 Press the  key to display "ELr no".
- 4 Press the  key to select "ELr Go".
- 5 Press the  key to execute initialization. After "End", the next item is displayed. Initialization has completed.
- 6 Press the  key to return to the standby mode.

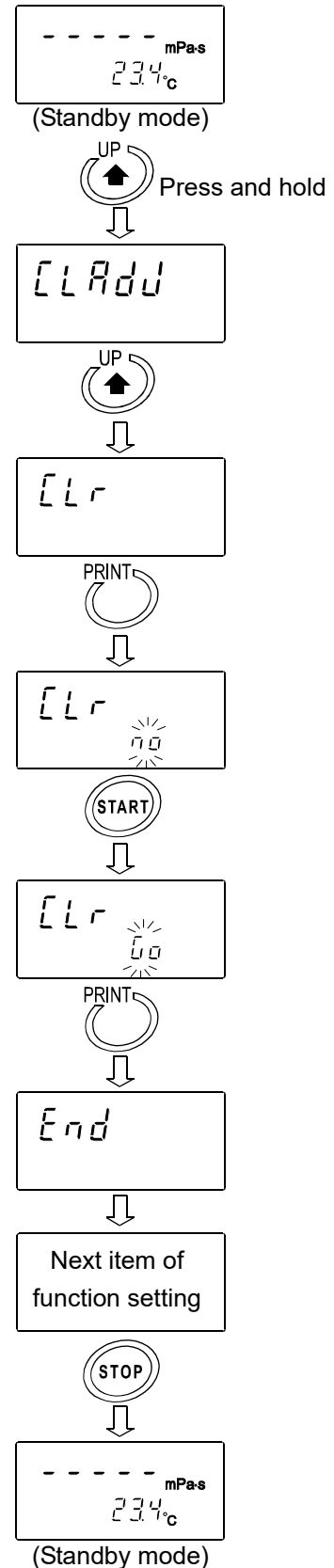

Date/Time (CLAdj)



- The upper two digits of the year are not displayed. For example, the year 2007 is displayed as "07".
- The time is set using the 24-hour system.
- Do not enter a non-existing date and time.

Set the order of the date, the date and time as follows:

(Example: To change April 5, 2003, 11:22:33 to June 8, 2004, 12:34:00)

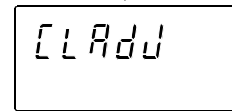
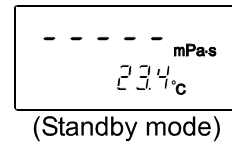
- 1 In the standby mode, press and hold the  key to enter the function setting mode. "CLAdj" appears.



- 2 Press the  key to display the current date. When the date is not to be changed, press the  key to display the current time.

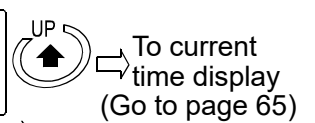
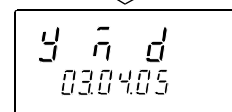

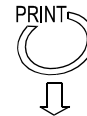

(Current date display)



Changing the order of the date

- 3 Press the  key. "y" (Year), "n" (Month) and "d" (Day) blink.



- 4 Press the  key or  key to change the order of displaying the date.

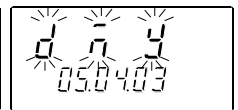
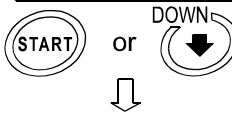

(Year/Month/Day)

(Month/Day/Year)

(Day/Month/Year)















Continued on the next page

Changing the date

The date is changed in the selected displaying order.

The following is an example when the order of "y" (Year), "n" (Month) and "d" (Day) is selected.

- 5 Press the  key to select the setting value of "y" (Year). (Example:03)
- 6 Press the  key or  key to change the year. (Example:03→04)
 key Increases the value of the blinking digit by one.
 key Decreases the value of the blinking digit by one.
- 7 Press the  key to select the setting value of "n" (Month). (Example:04)
- 8 Press the  key or  key to change the month. (Example:04→06)
- 9 Press the  key to select the setting value of "d" (Day). (Example:05)
- 10 Press the  key or  key to change the day. (Example:05→08)
- 11 Press the  key to save the date.
After "End", the current time is displayed.

From the previous page

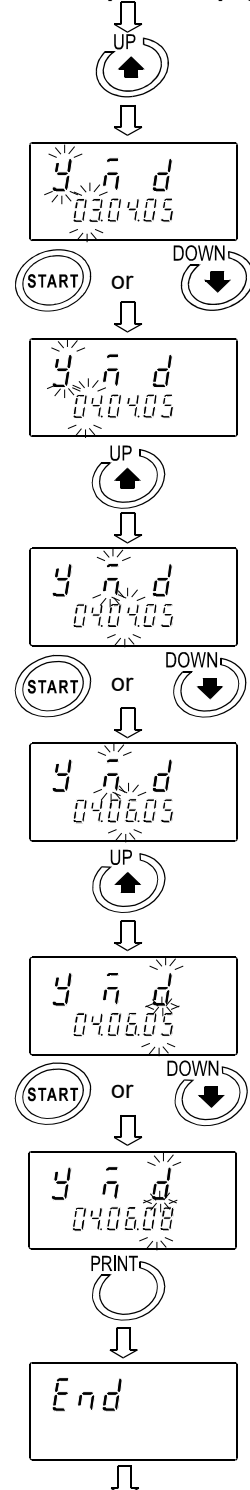



Continued on the next page

Changing the time



- 12 The current time is displayed. Press the  key to display the current date.

To current date display
(Go to page 63)



- 13 Press the  key to select the setting value of the hour. (Example:11)

- 14 Press the  key or  key to change the hour. (Example:11→12)

- 15 Press the  key to select the setting value of the minute. (Example:22)

- 16 Press the  key or  key to change the minute. (Example:22→34)

- 17 Press the  key to select the setting value of the second. (Example:33)

- 18 Press the  key or  key to change the second. (Example:33→00)

- 19 Press the  key to save the time.
After "End", the next item is displayed.

- 20 Press the  key to return to the standby mode.

From the previous page

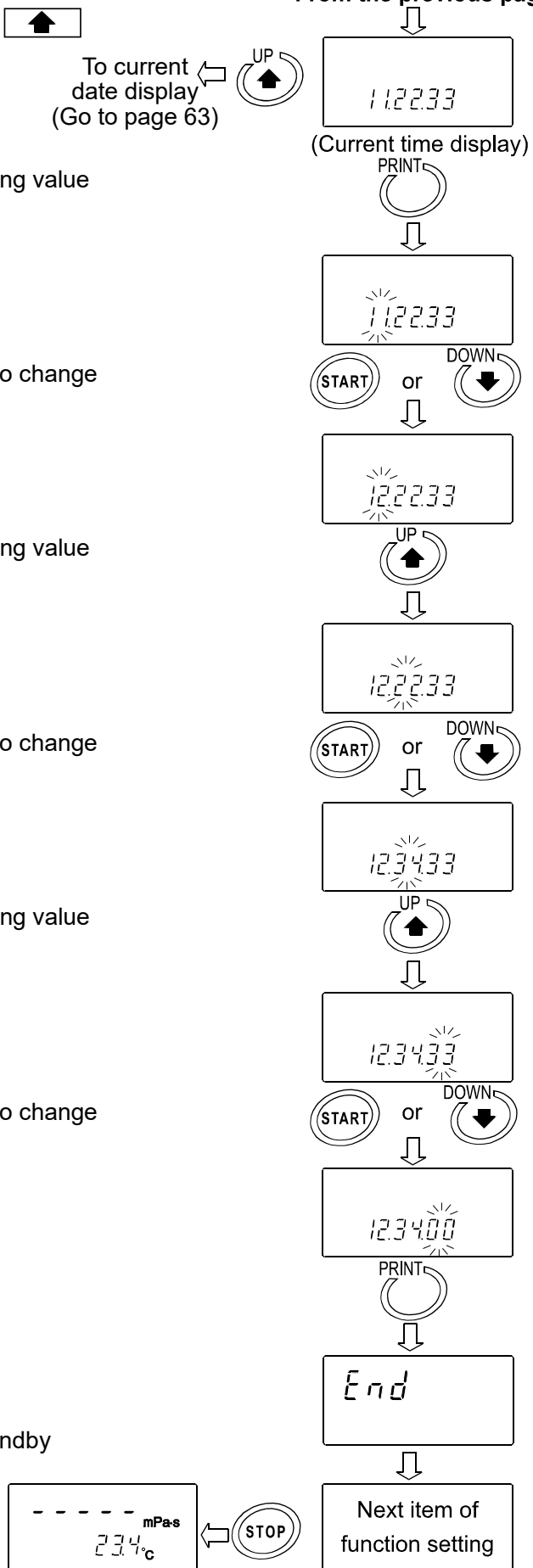

10-4 Data Output Format Examples

10-4-1 A&D Standard Format

Used with the printer MODE 3 when the optional compact printer AD-8121B is connected. Only the viscosity value is output.

Output format example

Viscosity unit	Display	Output format	Remarks
MmPa·s	LLLLLmPa·s	OL, -99999999mPs	Below measuring range error
	0.30mPa·s	ST, +00000.30mPs	
	10.0 mPa·s	ST, +00010.00mPs	The digit of 0.01mPa·s is always zero.
	100 mPa·s	ST, +00100.00mPs	The digits of 0.01mPa·s and 0.1mPa·s are always zero.
	1.00 Pa·s	ST, +01000.00mPs	For 1000mPa·s or greater, the displayed unit is Pa·s, but the output unit remains mPa·s. The digits of 0.01mPa·s, 0.1mPa·s and 1mPa·s are always zero.
	H Pa·s	OL, +99999999mPs	Above measuring range error
Pa·s	L Pa·s	OL, -99999999Pas	Below measuring range error
	0.0003 Pa·s	ST, +000.0003Pas	
	0.0100 Pa·s	ST, +000.0100Pas	
	0.100 Pa·s	ST, +000.1000Pas	The digit of 0.0001Pa·s is always zero.
	1.00 Pa·s	ST, +001.0000Pas	The digits of 0.0001Pa·s and 0.001Pa·s are always zero.
	H Pa·s	OL, +99999999Pas	Above measuring range error
CcP	L cP	OL, -99999999┘CP	Below measuring range error
	0.30 cP	ST, +00000.30┘CP	
	10.0 cP	ST, +00010.00┘CP	The digit of 0.01cP is always zero.
	100 cP	ST, +00100.00┘CP	The digits of 0.01cP and 0.1cP are always zero.
	10.0 P	ST, +01000.00┘CP	For 1000 cP or greater, the displayed unit is P, but the output unit remains cP. The digits of 0.01cP, 0.1cP and 1cP are always zero.
	H P	OL, +99999999┘CP	Above measuring range error
P	L P	OL, -99999999┘┘P	Below measuring range error
	0.0030 P	ST, +000.0030┘┘P	
	0.100 P	ST, +000.1000┘┘P	The digit of 0.0001P is always zero.
	1.00 P	ST, +001.0000┘┘P	The digits of 0.0001P and 0.001P are always zero.
	10.0 P	ST, +010.0000┘┘P	The digits of 0.0001P, 0.001P and 0.01P are always zero.
	H P	OL, +99999999┘┘P	Above measuring range error

┘ : Space (ASC 20h)

10-4-2 D.P. Format

Used with the printer MODE 3 when the optional compact printer AD-8121B is connected.

With "Prt 0" or "Prt 1" selected for "Data output mode (Prt)", output contents can be selected by the settings of "S-Rt", "S-td" and "S-Ed".

With "Prt 2" selected for "Data output mode (Prt)", only the viscosity value is output

The following shows printing examples.

Printing format example (1)

Function setting (√=Output Blank=No output)			
S-Rt	1	Measurement elapsed time	√
S-td	1	Date/time	√
S-Ed	2	Remarks	√
		Device ID information	√
		Signature	

①②③④⑤⑥⑦⑧⑨⑩⑪⑫⑬⑭⑮⑯

```

A&D
MODEL RV-10000
S/N 14800000
ID LAB-12
- - - - -
00:12:34
25.6 C
12.3 mPa s
0.40 mm
DATE 2003/03/31
TIME 12:34:56
REMARKS
- - - - -
SIGNATURE
- - - - -
    
```

← Device ID information
 ← Manufacturer
 ← Model
 ← Serial number
 ← ID number
 ← Measurement elapsed time
 ← Sample temperature
 ← Viscosity
 ← Amplitude value
 ← Date (*)
 ← Time
 ← Remarks
 ← Signature

Printing format example (2)

Function setting (√=Output Blank=No output)			
S-Rt	1	Measurement elapsed time	√
S-td	1	Date/time	√
S-Ed	1	Remarks	√
		Device ID information	
		Signature	

①②③④⑤⑥⑦⑧⑨⑩⑪⑫⑬⑭⑮⑯

```

00:12:34
25.6 C
12.3 mPa s
0.40 mm
DATE 2003/03/31
TIME 12:34:56
REMARKS
- - - - -
    
```

← Measurement elapsed time
 ← Sample temperature
 ← Viscosity
 ← Amplitude value
 ← Date (*)
 ← Time
 ← Remarks

Printing format example (3)

Function setting (√=Output Blank=No output)			
S-Rt	1	Measurement elapsed time	√
S-td	1	Date/time	√
S-Ed	0	Remarks	
		Device ID information	
		Signature	

①②③④⑤⑥⑦⑧⑨⑩⑪⑫⑬⑭⑮⑯

```

00:12:34
25.6 C
12.3 mPa s
0.40 mm
DATE 2003/03/31
TIME 12:34:56
- - - - -
    
```

← Measurement elapsed time
 ← Sample temperature
 ← Viscosity
 ← Amplitude value
 ← Date (*)
 ← Time

(*) The displaying order of the date (YMD/DMY/MDY) depends on the setting of "Date/Time (ELAdJ)".

Printing format example (4)

Function setting (√=Output Blank=No output)			
S-Rt	1	Measurement elapsed time	√
S-td	0	Date/time	
S-Ed	0	Remarks	
		Device ID information	
		Signature	

①	②	③	④	⑤	⑥	⑦	⑧	⑨	⑩	⑪	⑫	⑬	⑭	⑮	⑯
			0	0	:	1	2	:	3	4					

← Measurement elapsed time
 ← Sample temperature
 ← Viscosity
 ← Amplitude value

Printing format example (5)

Function setting (√=Output Blank=No output)			
S-Rt	0	Measurement elapsed time	
S-td	0	Date/time	
S-Ed	0	Remarks	
		Device ID information	
		Signature	

①	②	③	④	⑤	⑥	⑦	⑧	⑨	⑩	⑪	⑫	⑬	⑭	⑮	⑯

← Sample temperature
 ← Viscosity
 ← Amplitude value

10-4-3 CSV Format

Appropriate when a personal computer is used to collect data. Measurement values are output in comma separated format.

With "S-td" setting, the date and time can be added to the measurement data.

When a comma is selected as the decimal point by "Pnt 1", a semicolon ";" is used as a data separator.

With CSV format selected, the viscosity value and the temperature are output using the internal resolution.

The relation between the measuring unit and the internal resolution is as follows:

	Viscosity				Temperature		Amplitude value
	mPa·s	Pa·s	cP	P	°C	°F	mm
Internal resolution	0.01	0.0001	0.01	0.0001	0.01	0.01	0.01
	—	0.01	—	0.1			

Output format example (1) With ID number, date and time added

Function setting (√=Output Blank=No output)			
S-td	1	Date/time	√
S-Ed	3	Device ID number	√

Outputs in the order of ID number, date, time, temperature, temperature unit, viscosity and viscosity unit.

The output data are 52 characters long excluding the terminator.

Output format example

Viscosity / Temperature	Display	Output format example	Remarks
mmPa·s / °C	LLLLLmPa·s	LAB-12, 2003/03/19, 12:34:56, +025.67, C, +00000.00, mPa·s, 0.40, mm	Zeroes are output for below measuring range error.
	0.30mPa·s	LAB-12, 2003/03/19, 12:34:56, +025.67, C, +00000.30, mPa·s, 0.40, mm	
	10.0 mPa·s	LAB-12, 2003/03/19, 12:34:56, +025.67, C, +00010.00, mPa·s, 0.40, mm	
	100 mPa·s	LAB-12, 2003/03/19, 12:34:56, +025.67, C, +00100.00, mPa·s, 0.40, mm	
	1.00 Pa·s	LAB-12, 2003/03/19, 12:34:56, +025.67, C, +01000.00, mPa·s, 0.40, mm	For 1000 mPa·s or greater, the displayed unit is Pa·s, but the output unit remains mPa·s.
	H Pa·s	LAB-12, 2003/03/19, 12:34:56, +025.67, C, +12000.00, mPa·s, 0.40, mm	12000 is output for above measuring range error.
Pa·s / °F	L Pa·s	LAB-12, 2003/03/19, 12:34:56, +051.23, F, +000.0000, Pa·s, 0.40, mm	Zeroes are output for below measuring range error.
	0.0003 Pa·s	LAB-12, 2003/03/19, 12:34:56, +051.23, F, +000.0003, Pa·s, 0.40, mm	
	0.0100 Pa·s	LAB-12, 2003/03/19, 12:34:56, +051.23, F, +000.0100, Pa·s, 0.40, mm	
	0.100 Pa·s	LAB-12, 2003/03/19, 12:34:56, +051.23, F, +000.1000, Pa·s, 0.40, mm	
	1.00 Pa·s	LAB-12, 2003/03/19, 12:34:56, +051.23, F, +001.0000, Pa·s, 0.40, mm	
	H Pa·s	LAB-12, 2003/03/19, 12:34:56, +051.23, F, +012.0000, Pa·s, 0.40, mm	12 is output for above measuring range error.
cP / °C	L cP	LAB-12, 2003/03/19, 12:34:56, +025.67, C, +000.0000, cP, 0.40, mm	Zeroes are output for below measuring range error.
	0.30 cP	LAB-12, 2003/03/19, 12:34:56, +025.67, C, +00000.30, cP, 0.40, mm	
	10.0 cP	LAB-12, 2003/03/19, 12:34:56, +025.67, C, +00010.00, cP, 0.40, mm	
	100 cP	LAB-12, 2003/03/19, 12:34:56, +025.67, C, +00100.00, cP, 0.40, mm	
	10.0 P	LAB-12, 2003/03/19, 12:34:56, +025.67, C, +01000.00, cP, 0.40, mm	For 1000 cP or greater, the displayed unit is P, but the output unit remains cP.
	H P	LAB-12, 2003/03/19, 12:34:56, +025.67, C, +12000.00, cP, 0.40, mm	12000 is output for above measuring range error.
P / °F	L P	LAB-12, 2003/03/19, 12:34:56, +051.23, F, +000.0000, P, 0.40, mm	Zeroes are output for below measuring range error.
	0.0030 P	LAB-12, 2003/03/19, 12:34:56, +051.23, F, +000.0030, P, 0.40, mm	
	0.100 P	LAB-12, 2003/03/19, 12:34:56, +051.23, F, +000.1000, P, 0.40, mm	
	1.00 P	LAB-12, 2003/03/19, 12:34:56, +051.23, F, +001.0000, P, 0.40, mm	
	10.0 P	LAB-12, 2003/03/19, 12:34:56, +051.23, F, +010.0000, P, 0.40, mm	
	H P	LAB-12, 2003/03/19, 12:34:56, +051.23, F, +120.0000, P, 0.40, mm	120 is output for above measuring range error.

␣ : Space (ASC 20h)

Output format example (2) With date and time added

Function setting (√=Output Blank=No output)		
S-t d	1	Date/time
S-E d	0	Device ID number

Outputs in the order of date, time, temperature, temperature unit, viscosity and viscosity unit.

The output data are 46 characters long excluding the terminator.

Output format example

Viscosity / Temperature	Display	Output format example
MmPa·s / °C	1.23 mPa·s	,2003/03/19,12:34:56,+025.67,C,+00001.23,mPa·s,0.40,mm

□ : Space (ASC 20h)

Output format example (3) To output the measured temperature and viscosity only

Function setting (√=Output Blank=No output)		
S-t d	0	Date/time
S-E d	0	Device ID number

Outputs in the order of temperature, temperature unit, viscosity and viscosity unit.

The output data are 28 characters long excluding the terminator.

Output format example

Viscosity / Temperature	Display	Output format example
mmPa·s / °C	1.23 mPa·s	,,,+025.67,C,+00001.23,mPa·s,0.40,mm

□ : Space (ASC 20h)

10-4-4 RsVisco Format

Used with the graphing program RsVisco. Measurement data are output in comma separated format.

When a comma is selected as the decimal point by "P n t 1", a semicolon ";" is used as a data separator.

When a measurement is started using RsVisco, the rheometer automatically selects this format.

Measurement data are output in the order of viscosity, viscosity unit, temperature and temperature unit.

The output data are 25 characters long excluding the terminator.

With RsVisco format selected, the viscosity value and the temperature are output using the internal resolution.

The relation between the measuring unit and the internal resolution is as follows:

	Viscosity				Temperature		Amplitude value
	mPa·s	Pa·s	mm	P	°C	°F	mm
Internal resolution	0.01	0.0001	0.01	0.0001	0.01	0.01	0.01
	—	0.01	—	0.1			

Output format example

Viscosity / Temperature	Display	Output format example	Remarks
MmPa·s / °C	LLLLL mPa·s	+00000.00, mPa·s, +025.67, C, 0.40, mm	Zeroes are output for below measuring range error.
	0.30 mPa·s	+00000.30, mPa·s, +025.67, C, 0.40, mm	
	10.0 mPa·s	+00010.00, mPa·s, +025.67, C, 0.40, mm	
	100 mPa·s	+00100.00, mPa·s, +025.67, C, 0.40, mm	
	1.00 Pa·s	+01000.00, mPa·s, +025.67, C, 0.40, mm	For 1000 mPa·s or greater, the displayed unit is Pa·s, but the output unit remains mPa·s.
	H Pa·s	+12000.00, mPa·s, +025.67, C, 0.40, mm	12000 is output for above measuring range error.
Pa·s / °F	L Pa·s	+000.0000, Pa·s, +051.23, F, 0.40, mm	Zeroes are output for below measuring range error.
	0.0003 Pa·s	+000.0003, Pa·s, +051.23, F, 0.40, mm	
	0.0100 Pa·s	+000.0100, Pa·s, +051.23, F, 0.40, mm	
	0.100 Pa·s	+000.1000, Pa·s, +051.23, F, 0.40, mm	
	1.00 Pa·s	+001.0000, Pa·s, +051.23, F, 0.40, mm	
	H Pa·s	+012.0000, Pa·s, +051.23, F, 0.40, mm	12 is output for above measuring range error.
CcP / °C	L cP	+000.0000, cP, +025.67, C, 0.40, mm	Zeroes are output for below measuring range error.
	0.30 cP	+00000.30, cP, +025.67, C, 0.40, mm	
	10.0 cP	+00010.00, cP, +025.67, C, 0.40, mm	
	100 cP	+00100.00, cP, +025.67, C, 0.40, mm	
	10.0 P	+01000.00, cP, +025.67, C, 0.40, mm	For 1000 cP or greater, the displayed unit is P, but the output unit remains cP.
	H P	+12000.00, cP, +025.67, C, 0.40, mm	12000 is output for above measuring range error.
P / °F	L P	+000.0000, P, +051.23, F, 0.40, mm	Zeroes are output for below measuring range error.
	0.0030 P	+000.0030, P, +051.23, F, 0.40, mm	
	0.100 P	+000.1000, P, +051.23, F, 0.40, mm	
	1.00 P	+001.0000, P, +051.23, F, 0.40, mm	
	10.0 P	+010.0000, P, +051.23, F, 0.40, mm	
	H P	+120.0000, P, +051.23, F, 0.40, mm	120 is output for above measuring range error.



␣ : Space (ASC 20h)

11. SETTING THE CONTROLLER

In the device settings, the date and time settings and the display backlight brightness can be changed.

Touch  in the HOME screen to open the device settings screen.

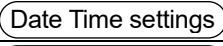
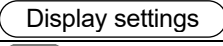

No.	Name	Description
1	 button	Set the date and time.
2	 button	Set the LCD backlight brightness.
3	 HOME button	Exits the device settings and returns to the HOME screen.

11-1 Setting the date and time

In the Device settings screen, touch the **Date Time settings** button to open the Date, Time settings screen.



Procedure



- 1 Touch the box for the date (year, month and day) and the time (hour and minute) to open the numerical value entry dialog. Enter the value for each box.
- 2 Touch the **Update** button. The date and time in the upper left corner of the screen will be updated.
It takes several seconds to update the date and time.
- 3 Touch the **Return** button to return to the Device settings screen.

11-2 Setting the display backlight brightness

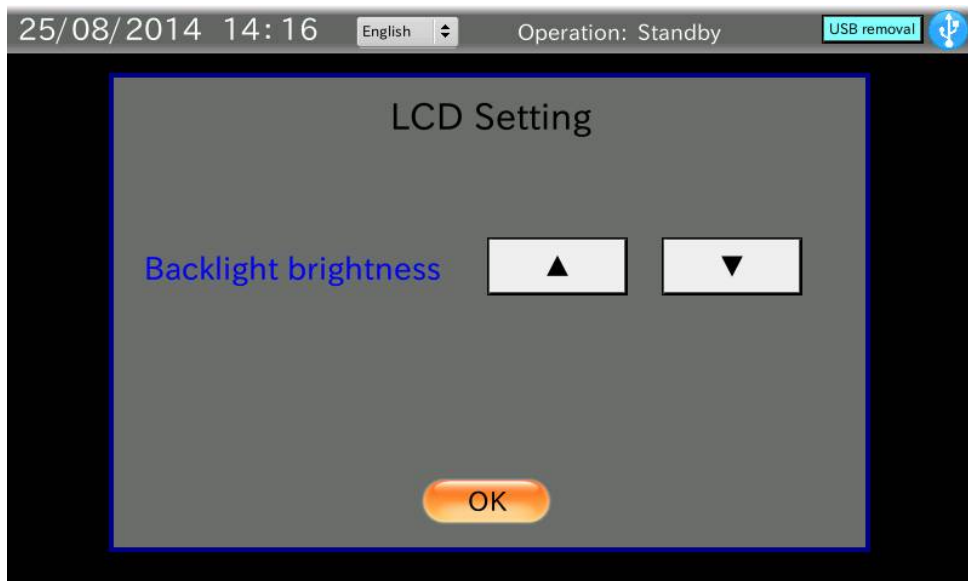
In the Device settings screen, touch the **Display settings** button to open the LCD setting screen.



Procedure

- 1 Touch the  button to decrease the brightness and touch the  button to increase the brightness. There are ten brightness levels.
The default value has been set to the maximum level.
- 2 Touch the  button to return to the Device settings screen.

11-3 Numerical value entry dialog

When numerical values are required, the numerical value entry dialog box appears.

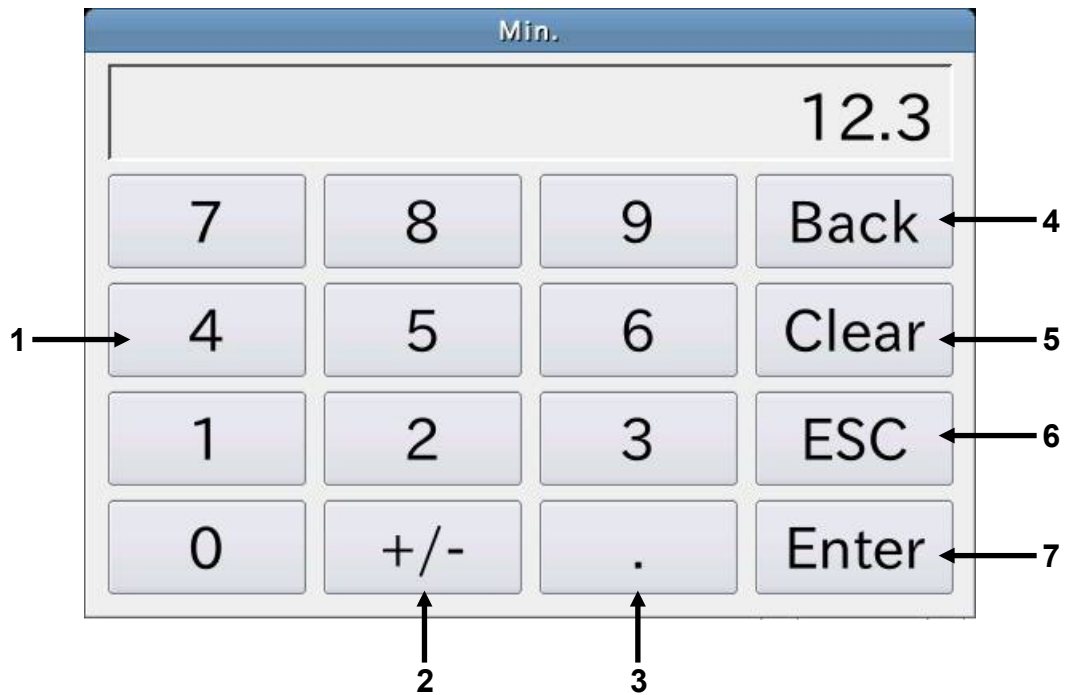

No.	Name	Description
1	Numerical value buttons	Enters numerical values.
2	+/- button	Switches the sign, + or -.
3	Decimal point button	Adds a decimal point.
4	Back button	Deletes one numerical value before the cursor.
5	Clear button	Deletes all the numerical values entered.
6	ESC button	Exits the dialog box without confirming the numerical values entered.
7	Enter button	Confirms the numerical values entered and exits the dialog box.

11-4 Character entry dialog

When characters are required, the character entry dialog box appears.

Touch the **MODE** button to switch between the alphabet entry dialog and the numerical value entry dialog.

Alphabet entry dialog

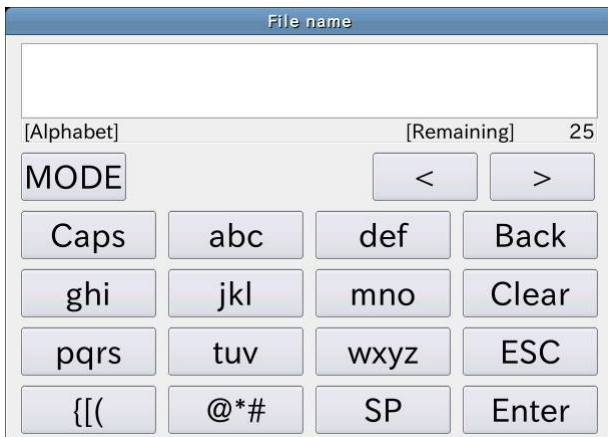

Numerical value entry dialog



11-5 Pulldown selection dialog

When an item selection is required, the pulldown selection dialog box appears.

Touch the item to be selected from the list and touch the **OK** button.

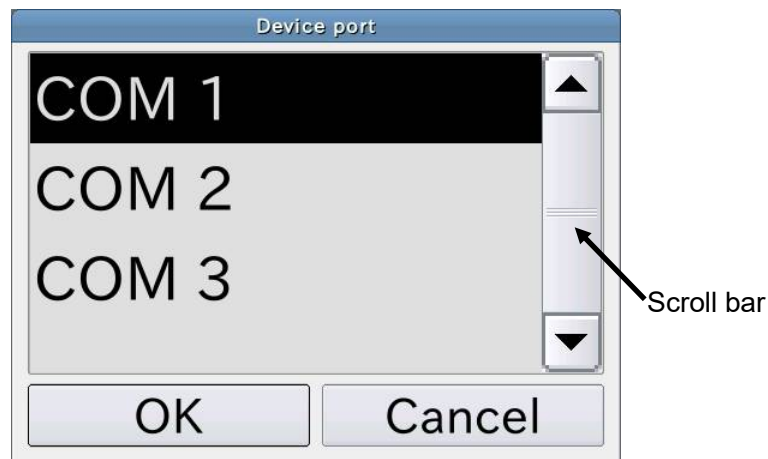

12. CONNECTION TO A PERSONAL COMPUTER

12-1 Introduction

If connecting the RV-10000A to a personal computer using the Windows communication tools WinCT-Viscosity (CD-ROM), the measurement data can be imported into the personal computer.

The graphing program RsVisco that is included in the Windows communication tools WinCT-Viscosity has following features.

- This program can display a graph of the sample viscosity changing in real time. At this time, the sample temperature is imported into the personal computer. Therefore you can easily understand the sample characteristic by displaying a graph of the relation between the temperature and viscosity.
 - When measuring at any time, you can compare the sample characteristic by displaying a graph on a graph.
 - The measurement data can be saved with the CSV file in the personal computer. The input data can be displayed as a graph again.
 - The graph data can be printed with a printer that is connected to the personal computer.
- * For an example of a measurement, refer to the sample measurement collection. For details of how to use the examples, refer to "Readme" that is installed in the personal computer after the CD-ROM set up.

12-2 Installation of WinCT-Viscosity

Refer to "\English\ReadMe.txt" on the CD-ROM, to install WinCT-Viscosity in a personal computer.

12-3 Connection to a personal computer

In a case where the personal computer has a COM port

The RV-10000A can connect to a personal computer using the RS-232C cable.

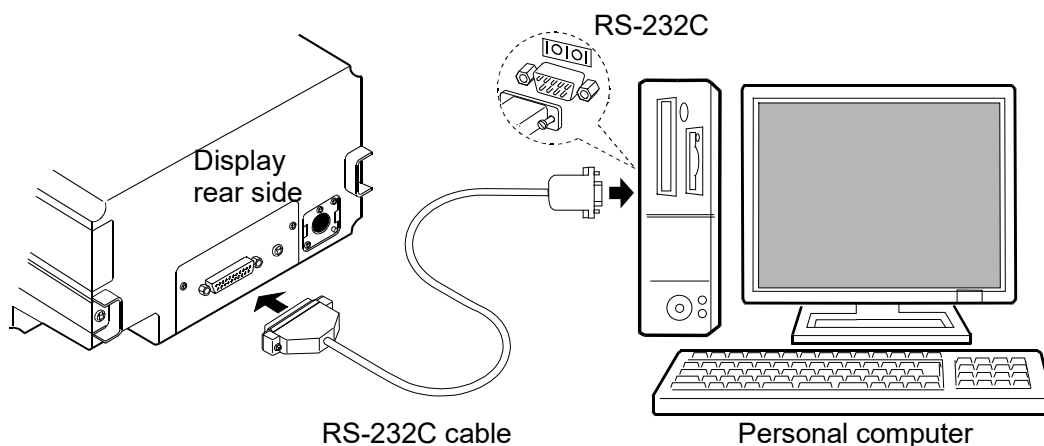

In a case where the personal computer does not have a COM port (Example: notebook type etc)

By using the standard Serial-USB converter provided, a personal computer can increase the number of COM ports available. Therefore, the RV-10000A can connect to a personal computer using the RS-232C cable.

Setting up

- 1 Connect the Serial-USB converter to the personal computer. Install the driver of the Serial-USB converter in the personal computer (Refer to the instruction manual of the Serial-USB converter.).
- 2 Connect the Serial-USB converter to the RV-10000A by using the RS-232C cable.

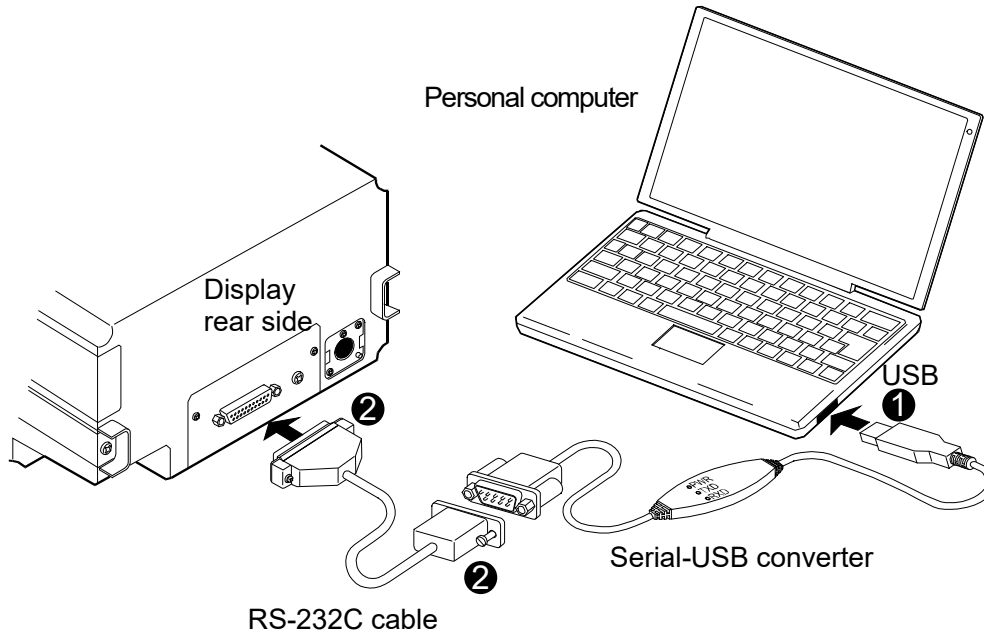

12-4 Configuration of the COM port

When connecting the RV-10000A to a personal computer, confirm that the COM port setting match up.

(1) Configuring of the COM port

- 1 Click the **START** bottom → the “Setting” → the “Control panel”.
- 2 Double-click the “System” .
- 3 Click the “Hardware” Tab, and click the “Device Manager” .
- 4 Double-click the “Port (COM and LPT)” , confirm the number of the COM port. When using the USB converter, “ATEN USB to Serial Bridge (COM4)” is displayed. With this example, the COM port is displayed set to “4”. The COM port of the personal computer is displayed as “Communications Port (COM1)”.

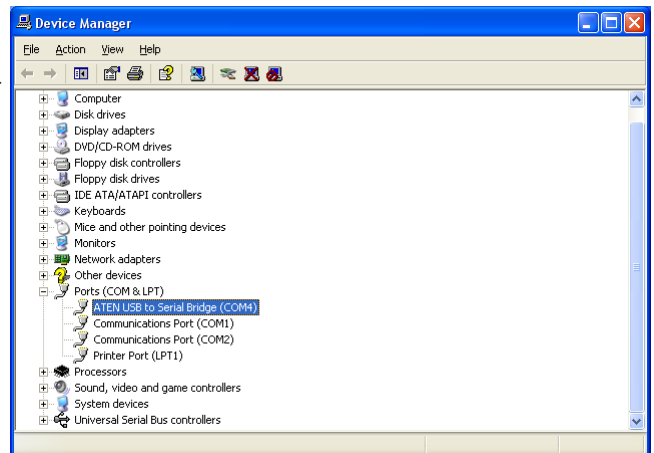

Confirming the COM port with the Device Manager (Example of the COM port of the USB converter set to “4”)

With this example, The COM port of the personal computer is two. Therefore, the COM port number that is connected to the personal computer directly is displayed as “1” and “2”. When a personal computer has many COM ports, all of the COM ports are displayed sequentially (Example: Communications Port (COM1), Communications Port (COM2)...). Confirm the COM port number by the connecting position of the COM port.

(2) Setting of the COM port (Example: graphing software “RsVisco”)

- 1 Click the **START** button → the “Program” → the “A&D WinCT-Viscosity” → the “RSVisco”.
- 2 With “RS-232C (R)” of menu → the “COM Port (C)”, set the COM port described above “ (1) Configuring of the COM port”

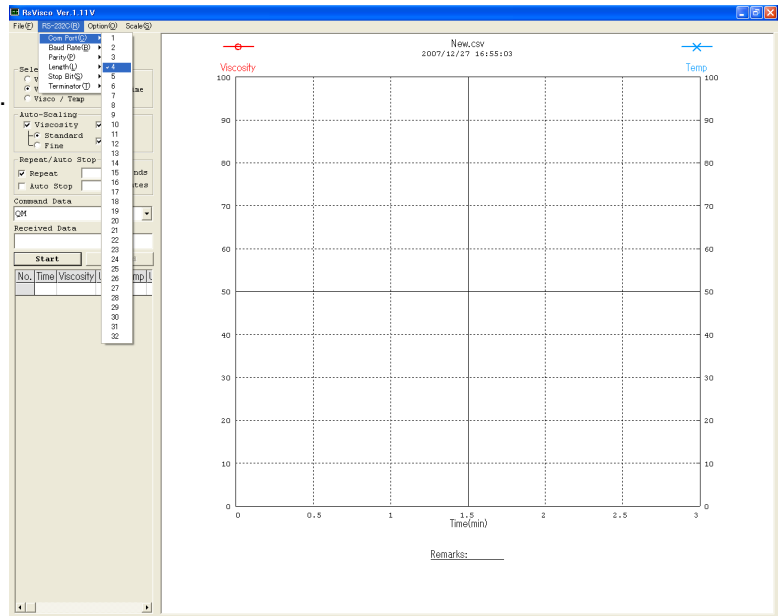

Setting the COM port with the RsVisco
(Example of the COM port set to “4”)

12-5 Controlling the measurement using a personal computer

(In case of the graphing software “RsVisco”)

- 1 Refer to “6. MEASUREMENT”, prepare the measurement.
- 2 Start the graphing software “RsVisco”.
- 3 Confirm that the COM port of the “RsVisco” is set properly.
- 4 Click the **Start** button of the “RsVisco” to start the measurement.
- 5 If you want to finish the measurement, click the **Stop** button of the “RsVisco”.

* For details on how to use the software, refer to the file “Readme” that is installed in a personal computer after the CD-ROM set up.

13. CONNECTION TO A PRINTER

- The rheometer can be connected to the optional compact printer AD-8121B using the standard RS-232C interface and the measurement results can be printed.
- The statistical calculation data of the results and the changes in the viscosity value per a certain time can be printed using the function of the AD-8121B.
- Use the AD-8121B accessory cable to connect the printer to the rheometer.

Setting List

What to print	Rheometer function settings						AD-8121B settings
	<i>Prt</i>	<i>TYPE</i>	<i>S-Rt</i>	<i>S-td</i>	<i>S-Ed</i>	<i>PUSE</i>	
Measurement results	0, 1	1	0, 1	0, 1	0, 1, 2	1	MODE 3

- Factory setting

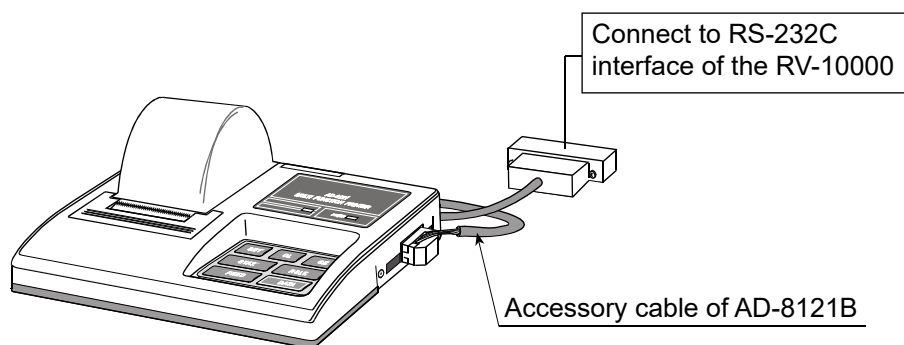

Compact printer AD-8121B

Note

AD-8121B settings

Mode	AD-8121B DIP switches	Description
Mode 1		Prints upon data receipt Standard mode, statistical calculation mode
Mode 2		Prints using the AD-8121B DATA key or the AD-8121B built-in timer Standard mode, interval mode, chart mode
Mode 3		Prints upon data receipt Dump print mode

DIP switch 3: Handling unstable data

ON = To print unstable data OFF = Not to print unstable data

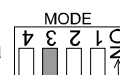

DIP switch 4: Data input specification

ON = Use the current loop OFF = Use the RS-232C

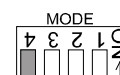

14. RS-232C INTERFACE

Display unit

Transmission system EIA RS-232C
 Transmission form Asynchronous, bi-directional, half duplex
 Data format Baud rate 2400 bps
 Data bits 7 bits
 Parity EVEN
 Stop bit 1 bit
 Code ASCII
 Terminator CR LF (CR: 0Dh, LF: 0Ah)

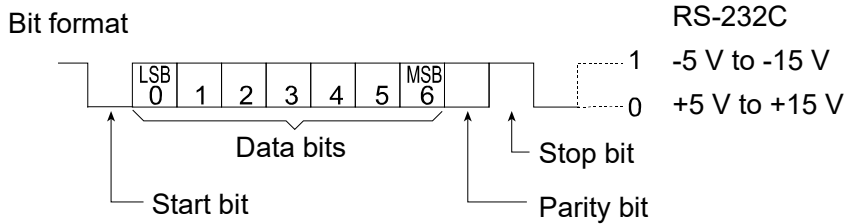

Pin Connections

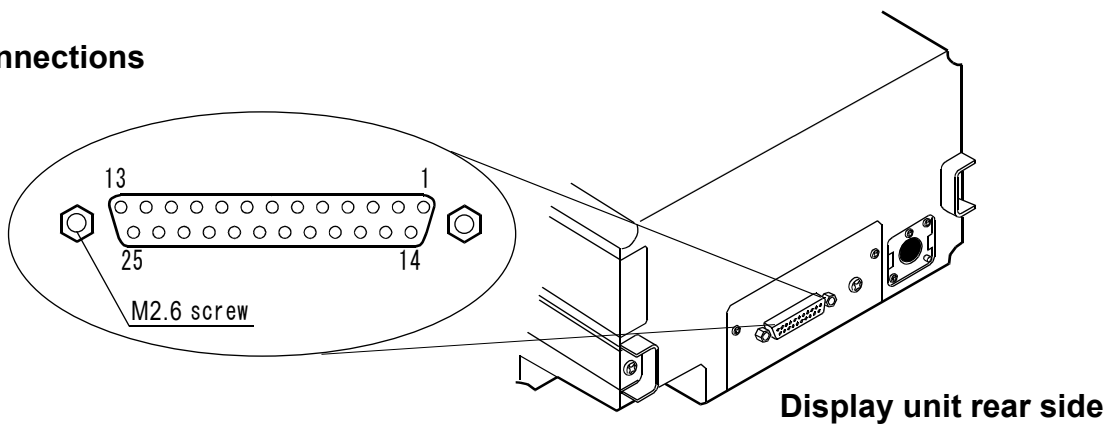

Pin No.	RV-10000A (DCE)		Computer (DTE)	
	Signal Name *1	Description	Direction	Signal Name
1	FG	Frame ground	-	FG
2	RXD	Receive data	←	TXD
3	TXD	Transmit data	→	RXD
4	RTS	Ready to send *2	←	RTS
5	CTS	Clear to send *2	→	CTS
6	DSR	Data set ready	→	DSR
7	SG	Signal ground	-	SG
16, 18, 19, 21, 23	Internal use		Do not connect *3	
Others	Not used			

*1: Signal names of the rheometer side are the same as the DTE side with TXD and RXD reversed.

*2: RTS and CTS flow control are not used. CTS output is HI always.

*3: Normal DOS/V cables do not use these terminals.

Controller

The controller is a DTE device. Connect the Main unit display (DCE) to the controller using a straight through cable.

Transmission system : EIA RS-232C

Transmission form : Asynchronous, bi-directional, half duplex

Data format : Baud rate : 600, 1200, 2400, 4800, 9600, 19200, 38400 bps

Data bits : 7 or 8 bits

Parity : Even, Odd (Data length 7 bits)

None (Data length 8 bits)

Stop bit : 1 bit

Code : ASCII

D-Sub 9-pin assignment



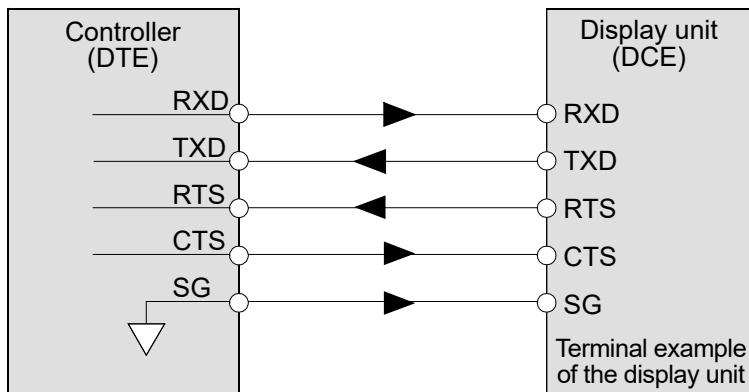
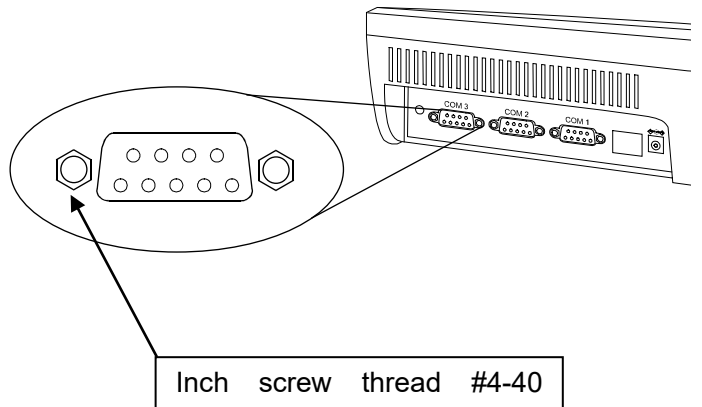

Pin No.	Signal name	Direction	Description
1	-	-	No connection
2	RXD	Input	Receive data
3	TXD	Output	Transmit data
4	-	-	No connection
5	SG	-	Signal ground
6	-	-	No connection
7	RTS	Output	Ready to send
8	CTS	Input	Clear to send
9	-	-	No connection



15. COMMAND LIST

The rheometer can be controlled by the following commands from the computer.

Add a terminator  (0Dh, 0Ah) to each command.

Command	Description
Q	Outputs the current data. (This is effective whether not measurement being carried out.)
SIR	Outputs data continuously
C	Stops data output by SIR command.
QM	Outputs the data during measurement. (This is effective only while measurement is being carried out.)
START	Same as the  key
STOP	Same as the  key
HOLD	Same as the  key
MODE	Same as the  key
PRINT	Same as the  key

16. TROUBLESHOOTING

The rheometer is a precision instrument. When the operating environment or the operating method is inadequate, correct values can not be obtained. If measurement values do not become stable or they seem to be incorrect, check as described below. If improper performance persists after checking, contact the local A&D dealer for repair.

16-1 When measurement values do not become stable

- ✓ Is the ambient environment free from vibration and drafts?
 - Places such as second or higher floor or near busy highways or rail lines are prone to vibration.
Avoid these places or use an anti-vibration table, AD-1671A.
 - Reconsider the setting of "Condition (ζ_{ond})" of the function setting.
Set it to " $\zeta_{ond} 2$ ".
 - Avoid direct drafts in the vicinity of the rheometer.
- ✓ Is there a strong electrical or magnetic noise source such as a motor near the rheometer?
 - Install the rheometer away from the electrical or magnetic noise sources
- ✓ Is the protector or the sensor protective cover in contact with the sensor plates or the temperature sensor?
 - Attach the protector and the sensor protective cover properly so that they do not touch the sensor plates or the temperature sensor.
 - Remove the protector, the surface locator plate or the sensor protective cover when necessary.

(1) How to remove the protector

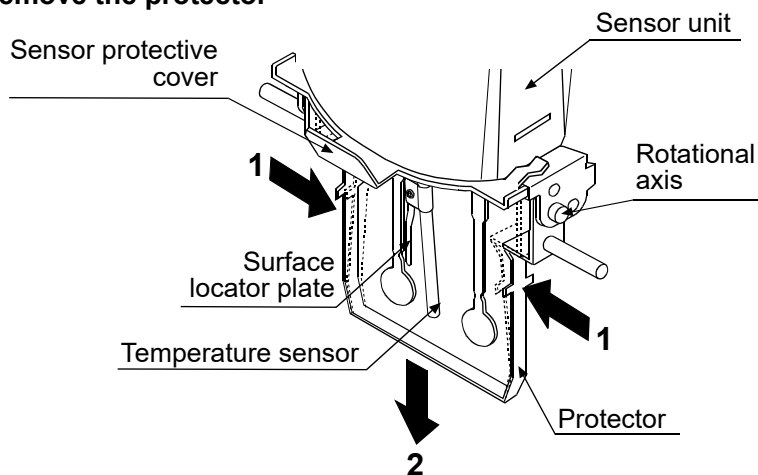

Press the left and right side frames lightly in the direction indicated as **1** to remove the rotational axis. Pull the protector in the direction indicated as **2** to remove.

(2) How to remove and attach the surface locator plate

Removing

Loosen the screw and remove the surface locator plate from the temperature sensor.

Attaching

Install the surface locator plate as shown in the illustration. Slip the locator plate onto the temperature sensor. Move the plate to the top of the sensor. Adjust the position of the locator plate so that the tip of the locator plate aligns to the center of the narrow part of the sensor plates. Tighten the screw.

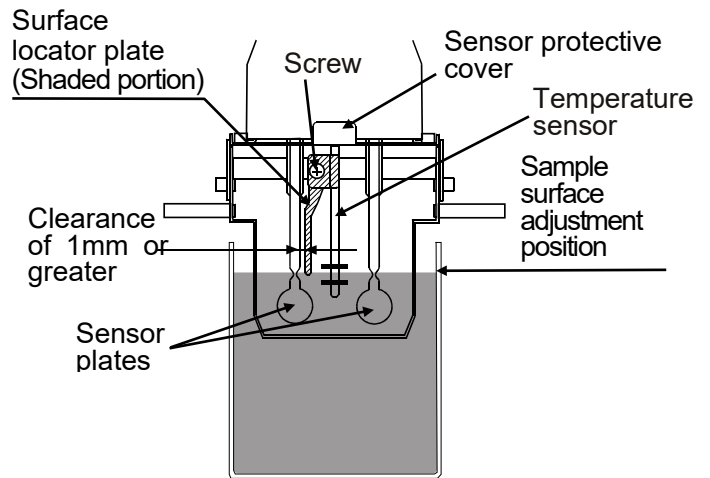

Note

When the sensor plate and the surface locator plate are too close, a measurement error may occur due to the liquid surface tension. Therefore, secure a clearance of at least 1 mm between the sensor plate and the surface locator plate. Maintain the clearance by rotating the surface locator plate when necessary.

(3) How to remove the sensor protective cover

Remove the protector and the surface locator plate.

Pull the sensor protective cover in the direction indicated as **1** to release the portions **A** (two) and **B** from the protector frame.

Pull the sensor protective cover in the direction indicated as **2** to remove.

Note

When removing the sensor protective cover, it may touch the sensor plates and the temperature sensor. Use much care not to damage them.

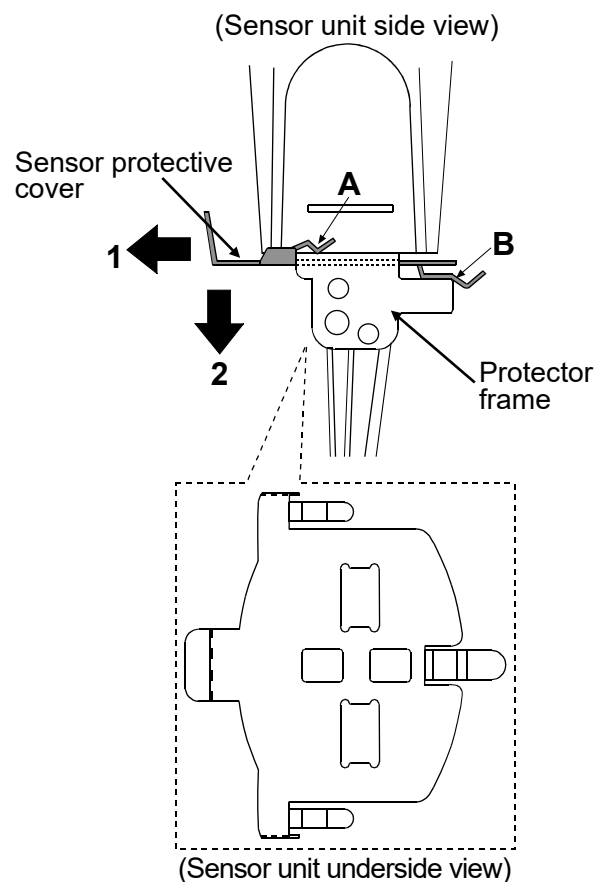

16-2 When measurement values are not correct

- ✓ Has the sample surface been adjusted to the center of the narrow part of the sensor plates?
 - Adjust the table height by turning the knob so that the center of the narrow part of the sensor plates is on the sample surface.
- ✓ Are the positions of the left and right sensor plates in the sample surface the same?
 - If not the same, level the rheometer using the leveling feet so that the liquid surface will be leveled.
- ✓ Are the sensor plates clean?
 - Remove any residual sample material from the sensor plates using alcohol.
 - When any residual sample material is on the portion of the sensor plates above the sample surface, changes in the mass cause the vibration frequency to shift, which will result in a measurement error.
- ✓ Are the sensor plates bent?
 - If bent, contact the local A&D dealer for repair.
- ✓ Is the protector properly attached to the rheometer.
- ✓ Does the sample generate bubbles because of the differences in the sample temperature and the ambient temperature and do the bubbles stick to the sensor plates?
- ✓ The sample viscosity depends on the temperature.
 - In general, because the viscosity of a liquid depends on its temperature, the viscosity value decreases about 2 to 10 percent per degree Celsius if increasing the temperature.
- ✓ Is the sample surface lowered?
 - In a measurement that takes a long time, evaporation may cause the sample surface to be lowered. Maintain the sample surface level.
- ✓ Do the main unit and the display unit have the same serial number?
 - The measuring unit and the display unit have been adjusted in pairs. Confirm that the measuring unit and the display unit have the same serial number.
- ✓ Is calibration performed?
 - When the absolute viscosity value is important, it is recommend that a periodic calibration be performed using a standard viscosity fluid.
- ✓ Sample cup influence
The rheometer have been calibrated with the following cups when shipped. When using another cup, use that cup to measure viscosity only after calibrating with it.
Sample cup (Capacity: 45 mL)

Note

The rheometer has been calibrated with the protector attached when shipped. Please note that the value, obtained when the rheometer is calibrated without the protector, may be different from that upon shipment.

16-3 When more precise measurement is required:

- ✓ When the rheometer is installed for the first time or is moved to another location, plug in the AC adapter and warm up the rheometer for one hour or more, to acclimatize the rheometer to the measuring environment.
And before measurement, calibrate the rheometer using the sample cup that will be used for measurement.
- ✓ Placing the sensor plates and the temperature sensor in the sample may change the sample temperature. For precise measurement, leave the sample as is for a while, after placing the sensor plates and the temperature sensor, to ensure no changes to the sample temperature. And then, start a measurement.
- ✓ When the sensor plates and the temperature sensor are cleaned using alcohol, the plates and the sensor are cooled temporarily and their temperature is lowered. Allow the plates and the sensor to acclimatize to the measuring environment before measurement.

16-4 When the temperature values are not correct

- ✓ Is the display unit connected to the measuring unit properly using the connection cable?



16-5 When water viscosity is to be measured

- ✓ When tap water is poured into the sample cup directly and is measured, bubbles are generated on the sensor plates due to the difference in pressure and temperature and the viscosity may increase gradually. Pressurized tap water generates bubbles easily. Therefore, use distilled or purified water that is not pressurized.
Leave the sensor plates and sample in the same environment to acclimatize before measuring, to decrease temperatures fluctuations.
- ✓ In a measurement that takes a long time, the sample viscosity may increase due to water contamination. Perform a periodic check on water quality.

16-6 When the controller and the main unit are not communicating

- ✓ Is an appropriate AC adapter connected?
- ✓ Is the controller connected to the main unit using an RS-232C straight through cable?

17. ERROR DISPLAY

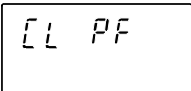
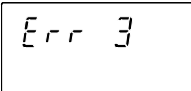
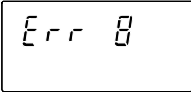
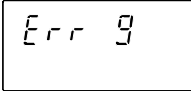
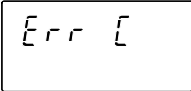
Error display	Description
	<p>Above measuring range error The viscosity value exceeds the upper limit of the viscosity measuring range. The viscosity of the sample can not be measured.</p> <p>This error may occur when the display unit is not connected to the measuring unit.</p>
	<p>Below measuring range error The viscosity value is below the lower limit of the viscosity measuring range. The viscosity of the sample can not be measured.</p> <p>This error may occur when the display unit is not connected to the measuring unit.</p>
	<p>The power supply for the internal clock is depleted. Press any key to enter the clock correction mode. Setting the clock enables the rheometer to be used temporarily. If the error occurs frequently, contact the local A&D dealer for repair.</p>
   	<p>Internal IC error Turn the power off. Then, turn the power on again. If this does not release the error, contact the local A&D dealer for repair.</p>

18. SPECIFICATIONS

Measurement method	Sine-wave Vibro Rheometer using the Tuning-fork Vibration method Vibration frequency 30 Hz		
Amplitude range	0.07 to 1.2mm (At the tip of the sensor plate)		
Viscosity measuring range	Amplitude (At the tip of the sensor plate, peak to peak [P-P])	Viscosity range	
	0.07mm - 0.1mm (0.07mm or more, less than 0.1mm)	2,000 - 25,000mPa·s	
	0.1mm - 0.2mm (0.1mm or more, less than 0.2mm)	20 - 25,000mPa·s	
	0.2mm	0.3 - 25,000mPa·s	
	0.2mm - 0.4mm (More than 0.2mm, 0.4mm or less)	0.3 - 12,000mPa·s	
	0.4mm - 0.8mm (More than 0.4mm, 0.8mm or less)	0.3 - 5,000mPa·s	
	0.8mm - 1.2mm (More than 0.8mm, 1.2mm or less)	0.3 - 3,000mPa·s	
Measurement accuracy*1	Repeatability*2	1% (Standard deviation)	
	Accuracy *3	±3% (1 - 1000mPa·s) When amplitude is set to 0.4mm	
Minimum display	Range (mPa·s)	Minimum display (mPa·s)	Minimum display (Pa·s)
	0.3 - 10	0.01	0.0001
	10 - 100	0.1	0.0001
	100 - 1000	1	0.001
	1000 - 25000	10 ⁴	0.01
Unit (Viscosity)	mmPa·s, Pa·s, cP, P		
Operating temperature	10 to 40°C (50 to 104°F)		
Minimum sample amount	10 mL or more		
Temperature display	0 to 99°C/0.1°C, (32 to 210.2°F/0.1°F) *5 100 to 160°C/1°C, (212 to 320°F/1°F)		
Temperature measurement accuracy	0 to 20°C/32 to 68°F: ±1°C/±1.8°F		
	20 to 30°C/68 to 86°F: ±0.5°C/±0.9°F		
	30 to 100°C/86 to 212°F: ±2°C/±3.6°F		
	100 to 160°C/212 to 320°F: ±4°C/±7.2°F		
Display	Vacuum fluorescent display (VFD)		
Connection cable length	1.5 m (between the measuring unit and the display unit)		
Communication	RS-232C standard		
Power supply	AC adapter (Confirm that the adapter type is correct for the local voltage and power receptacle type.)		
Power consumption	Approx. 14 VA (Including the AC adapter)		
External dimensions/mass	Sensor unit: 112 (W) x 132 (D) x 291 (H) mm/Approx. 0.8 kg		
	Display unit: 238 (W) x 132 (D) x 170 (H) mm/Approx. 1.3 kg		
	Stand unit: 296 (W) x 314 (D) x 536 (H) mm/Approx. 4.6 kg		
Standard accessories	AC adapter (1 pc), Connection cable (1 pc), Sample cup (Capacity: 45mL, 5 pcs), Small sample cup (Capacity: 10 mL, 5 pcs), Small sample cup cover (5 pcs), Disposable cup (Capacity: 10 mL, 5 pcs), Glass sample cup (Capacity: 13 mL, 2 pcs), Glass sample cup holder (1 pc), Water jacket (1 pc), Windows communication tools WinCT-Viscosity (1 pc), RS-232C cable (1 pc), Serial-USB converter (1 pc), Stand for securing the sensor unit (1 pc), Positioning stopper (1 pc), X-Y-Z stage (1 pc), Anti-vibration table (1 pc), Dust cover for the measuring unit (1 pc), Dust cover for the display unit and controller (2 pcs)		

- *1 When the sample cup (45mL) is used
- *2 Repetitive measurement with the sensor plates remaining in the sample
- *3 The value after calibration using a standard viscosity fluid at a temperature range between 20°C and 30°C with no condensation.
In a measurement that takes a long time, perform calibration using a standard viscosity fluid or purified water periodically, as necessary.
- *4 The unit switches to Pa.s.
- *5 The operating temperature of each standard and optional accessory is as follow

Name	Temperature used
Sample cup-capacity 45 mL (AX-SV-33), Small sample cup-capacity 10 mL / Small sample cup cover (AX-SV-34), Sample cup-capacity 2 mL (AX-SV-58)*, Sample cup holder-For capacity 2 mL (AX-SV-56-1/2)	0 to 120°C
Glass sample cup-capacity 13 mL (AX-SV-35), Glass sample cup-capacity 2 mL (AX-SV-59)	0 to 230°C
Water jacket (AX-SV-37)	0 to 100°C
Glass Storage Container (AX-SV-38)*	0 to 180°C
Plastic Storage Container (AX-SV-39)*, Disposable cup-capacity 10 mL (AX-SV-63)	0 to 80°C

* Lid: 80°C max

Take the operating temperature shown above into considerations when using the above items.

Controller

Display	TFT color LCD with backlight (7 inch, 800x480 dots)
Data transmission	RS-232C, USB (complying with USB1.1)*
Operating environment	5°C to 40°C, 85%RH or less (No condensation)
External dimensions	203 (W) x 153 (D) x 58 (H) mm, excluding protrusions
Power supply	AC adapter (Confirm that the adapter type is correct for the local voltage and power receptacle type.)
Power consumption	Approx. 30 VA
Mass	Approx. 1.1 kg

* USB interface is used for connecting a USB memory.

19. OPTIONAL ACCESSORIES

List of Optional Accessories (sold separately)

Model	Name
X-SV-31-2.5	Standard viscosity fluid (JS2.5)
AX-SV-31-5	Standard viscosity fluid (JS5)
AX-SV-31-10	Standard viscosity fluid (JS10)
AX-SV-31-20	Standard viscosity fluid (JS20)
AX-SV-31-50	Standard viscosity fluid (JS50)
AX-SV-31-100	Standard viscosity fluid (JS100)
AX-SV-31-200	Standard viscosity fluid (JS200)
AX-SV-31-500	Standard viscosity fluid (JS500)
AX-SV-31-1000	Standard viscosity fluid (JS1000)
AX-SV-31-2000	Standard viscosity fluid (JS2000)
AX-SV-31-14000	Standard viscosity fluid (JS14000)
AX-SV-31-160000	Standard viscosity fluid (JS160000)
AX-SV-33	Sample cup (Capacity: 45 mL) 10 pcs
AX-SV-34	Small sample cup (Capacity: 10 mL) 10 pcs
AX-SV-35	Glass sample cup (Capacity: Approx.13 mL) 1 pc
AX-SV-36	Positioning Stopper 1 pc
AX-SV-37	Water jacket 1 pc
AX-SV-38	Glass storage container (Capacity: Approx.50 mL) 10 pcs
AX-SV-39	Plastic storage container (Capacity: Approx.120 mL) 20 pcs
AX-SV-42	Analog output
AX-SV-43	Extension cable (5 m) To extend the distance between the measuring unit and the display unit.
AX-SV-51	Stand set Stand for securing the sensor unit 1 pc X-Y-Z stage 1 pc Sample cup (Capacity: 2 mL, Lid attached) 1 pc Sample cup holder (For 2 mL capacity) 1 pc Sample cup (Capacity: 45 mL) 1 pc
AX-SV-52	X-Y-Z stage 1 pc
AX-SV-53-EX	Software set (Serial-USB converter included) WinCT-Viscosity 1 pc RS232C straight cable 1 pc Serial-USB converter 1 pc
AX-SV-54	Cup set (Capacity: 10 mL · 13 mL · 45 mL) (Water jacket attached) Sample cup (Capacity: 45 mL) 5 pcs Small sample cup (Capacity: 10 mL) 5 pcs Small sample cup cover 5 pcs Glass sample cup (Capacity: Approx.13 mL) 2 pcs Glass sample cup holder 1 pc Water jacket 1 pc
AX-SV-62-1	Dust cover for the measuring unit
AX-SV-62-2	Dust cover for the display unit and controller
AX-SV-63	Disposable cup (Capacity: 10 mL) 40 pcs
AX-USB-25P-EX	Serial-USB converter
AD-8121B	Compact printer
AD-1671A	Anti-vibration table
AD-1682	Rechargeable battery
AD-1687	Weighing environment logger
AD-1688	Weighing data logger
AD-8527	Quick USB adapter

AX-SV-33 Sample Cup

- The AX-SV-33 consists of :

Sample cup (Capacity: 45 mL) 10 pcs
(Polycarbonate, Operating temperature: 120°C max.)

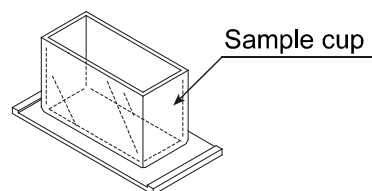

AX-SV-34 Small Sample Cup (10mL)

- Used when a small amount of sample will be measured.

- The AX-SV-34 consists of :

Small sample cup (10 mL) 10 pcs
Small sample cup cover 10 pcs
Sample cup 1 pc
(All: Polycarbonate, Operating temperature: 120°C max.)

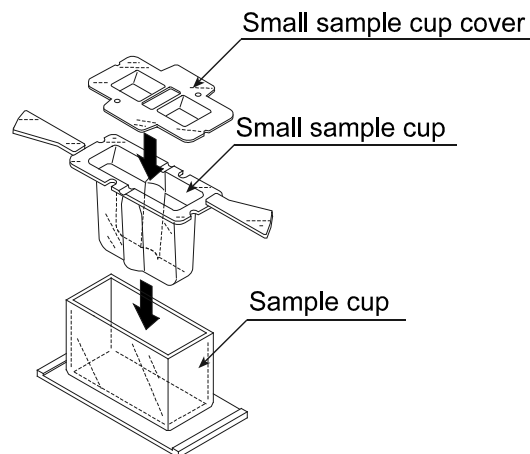

AX-SV-35 Glass Sample Cup (Approx. 13 mL)

- Used when organic solvents will be measured.

- The AX-SV-37 consists of :

Glass sample cup (Capacity: Approx.13 mL) 1 pc
(Pyrex® glass, Operating temperature: 230°C max.)
Glass sample cup holder (Stainless steel) 1 pc
Sample cup 1 pc
(Polycarbonate, Operating temperature: 120°C max.)

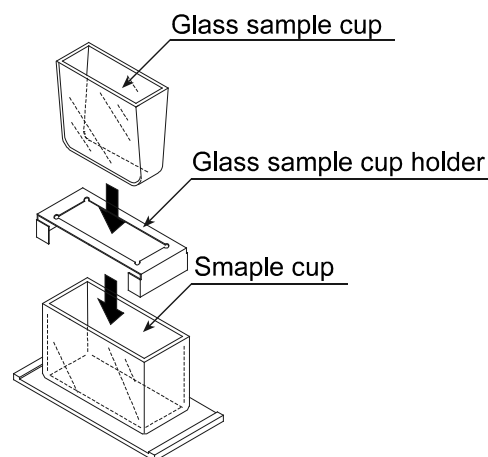

AX-SV-36 Positioning Stopper

- Used to fix the position of the sensor unit and the sensor plates so that positioning the sensor plates and the sample surface is not required each time a measurement is performed in a repetitive test. See below for how to attach the positioning stopper.

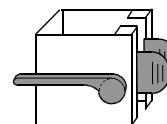

How to attach the positioning stopper:

- 1 Raise the lever so that the sensor unit can be moved.
- 2 While pinching the grips, lift out the sensor unit from above.
- 3 While pinching the grips on the positioning stopper, attach the stopper, with the lever on the left side as seen from front, on the supporting post. Be sure to place the guide located on the inner wall of the stopper in the guide channels located on the supporting post.
- 4 Position the stopper at an appropriate height. Raise the lever to secure the stopper.
- 5 While pinching the grips, attach the sensor unit on the supporting post.
- 6 Lower the sensor unit until it comes into contact with the stopper.
- 7 Lower the lever to secure the sensor unit.

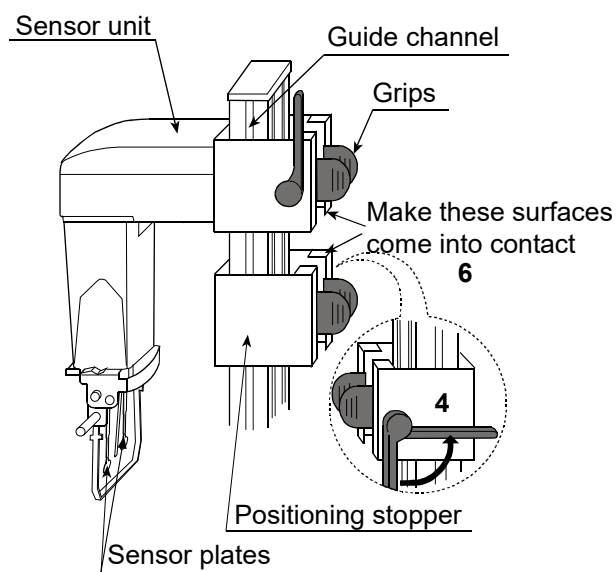
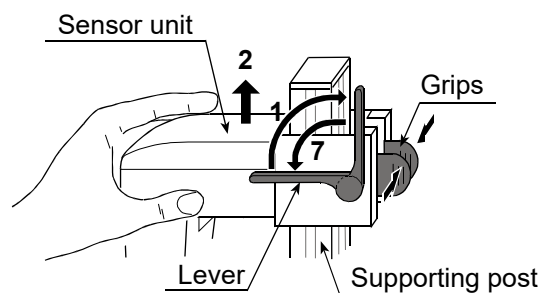

AX-SV-37 Water Jacket Assembly

- Used, in combination with a commercially available constant temperature bath for heating medium circulation, to maintain the sample temperature constant or to measure the viscosity while changing the sample temperature.
- The glass sample cup sold separately can also be used.
- The AX-SV-37 consists of :

Water jacket 1 pc
(Main body: Polycarbonate, Packing: Silicone rubber, Washer: Nylon)

Small sample cup 4 pcs
(Polycarbonate, Operating temperature: 120°C max.)

Small sample cup cover 4 pcs
(Polycarbonate, Operating temperature: 120°C max.)

Screw 1 pc
(Screw: Polyacetal, Washer: Nylon)

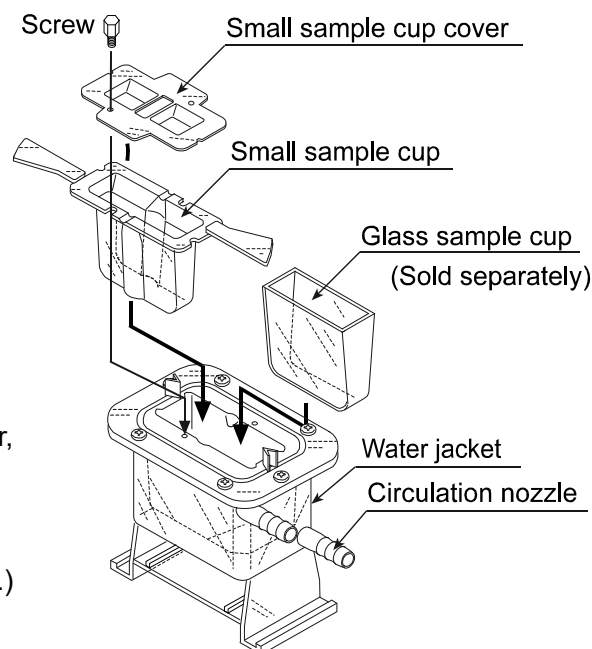

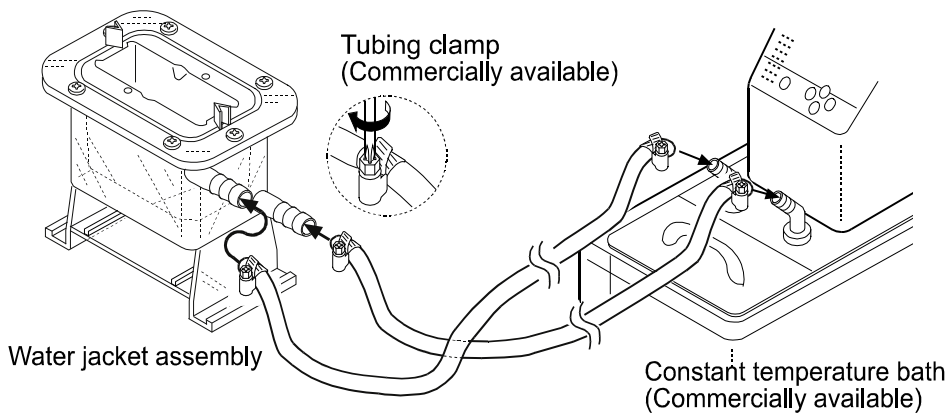

- Specifications Circulation nozzle: Outside diameter 10.5 mm
Recommended hose: Silicone tube, inside diameter 8 mm
- It is recommended that, for safety, a commercially available tubing clamp (clamping size: 11 to 20 mm) be used to fasten the tube securely to the nozzle.
- When using the water jacket, make sure that no inner pressure is exerted in the water jacket due to the kinked or blocked tubes, as that could exert the pressure in the water jacket, causing it to break.
- Set the circulation flow rate to 5 L/min or less. Otherwise, the water jacket may be damaged.
- When a stirrer is attached at the bottom of the water jacket, the sample viscosity can be measured while the sample is being stirred. The maximum viscosity value which can be measured is 1000 mPa·s.

Stirrer: Cimarec TM i Micro Stirrers manufactured by Thermo Fisher Scientific

Use a rotator with a size of 6 mm (length) x 4 mm (diameter).

AX-SV-38 Glass Storage Container

- Used to store sample fluids.
The viscosity of the sample stored in the container can be measured as it is.
- The AX-SV-38 consists of :
Glass storage container (Capacity: Approx.50 mL) 10 pcs
(Borosilicate glass, Operating temperature: 180°C max.)
Lid 10 pcs
(Polyethylene, Operating temperature: 80°C max.)

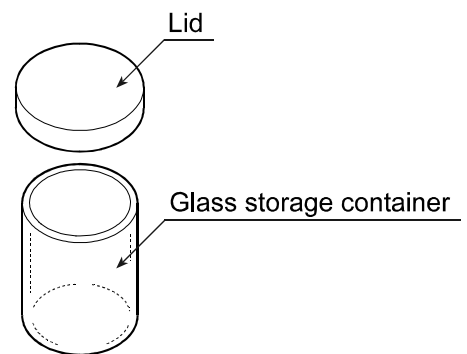

AX-SV-39 Plastic Storage Container

- Used to store sample fluids.
The viscosity of the sample stored in the container can be measured as it is.
- The AX-SV-39 consists of :
Plastic storage container (Capacity: Approx.120 mL) 20 pcs
(Polypropylene, Operating temperature: 80°C max.)
Lid 20 pcs
(Polyethylene, Operating temperature: 80°C max.)

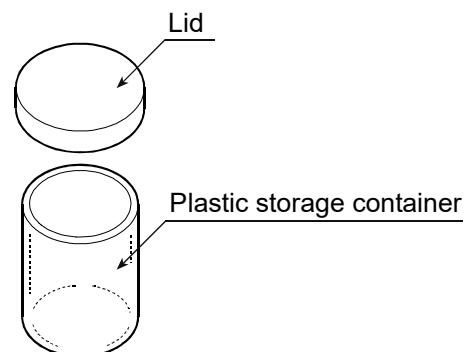

AX-SV-51 Stand Set

- Used for securing the sensor unit while measuring the viscosity of a sample.

- Consists of :

- Stand for securing the sensor unit
- X-Y-Z stage
- Stopper

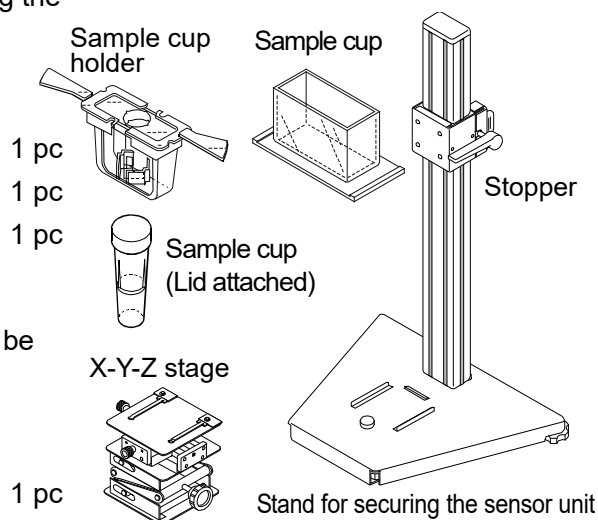

- Used when a small amount of sample (2 mL) will be measured. (Only for SV-1A/SV-1H)

- Consists of :

- Sample cup (Capacity: 2 mL) 1 pc
- Sample cup holder 1 pc
- Sample cup (Capacity: 45 mL) 1 pc
(Polycarbonate, Operating temperature: 120°C max.)
- Lid 1 pc
(Polypropylene, Operating temperature: 80°C max.)

AX-SV-52 X-Y-Z Stage

- Used to support and adjust the sample cup position.

- Consists of :

- X-Y-Z stage 1 pc

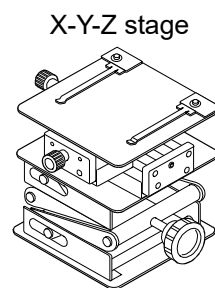

AX-SV-53-EX Software Set

- Used while acquiring the viscosity data with a personal computer.

- Consists of :

- WinCT-Viscosity 1 pc
- RS-232C straight cable 1 pc
- Serial-USB converter 1 pc

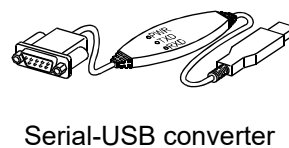
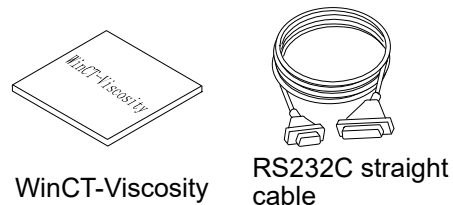

AX-SV-54 Cup Set (10 mL / 13 mL / 45 mL)

(Use the AX-SV-51 Stand Set if necessary.)

- Used when a small amount of sample will be measured.

- Consists of :

Sample cup (45 mL)	5 pcs
Small sample cup (10 mL)	5 pcs
Small sample cup cover	5 pcs
(All: Polycarbonate, Operating temperature: 120°C max.)	

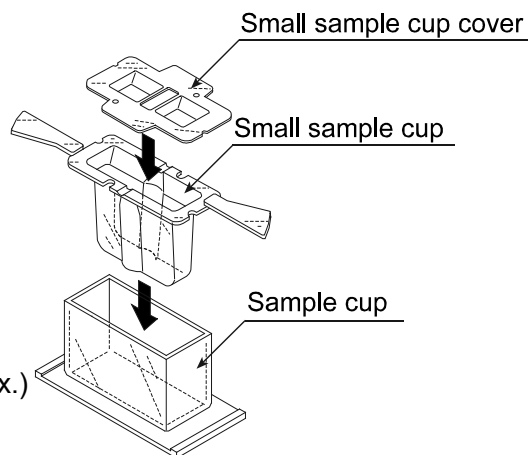

Used when organic solvents will be measured.

Glass sample cup (Capacity: Approx. 13 mL) 2 pcs
(Pyrex® glass, Operating temperature: 230°C max.)

Glass sample cup holder (Stainless steel) 1 pc

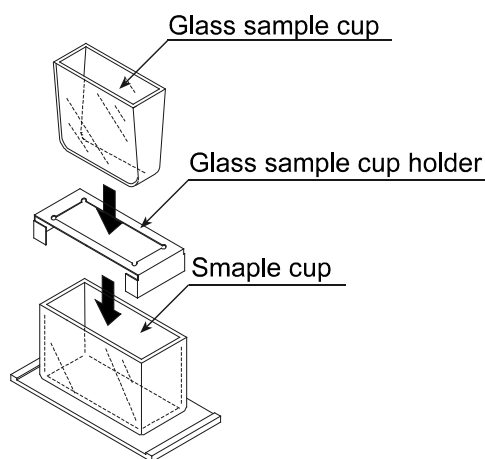

• Water Jacket

Used, in combination with a commercially available constant temperature bath for heating medium circulation, to maintain the sample temperature constant or to measure the viscosity while changing the sample temperature.

- Consists of :

Water jacket	1 pc
(Main body: Polycarbonate, Packing: Silicone rubber, Washer: Nylon)	

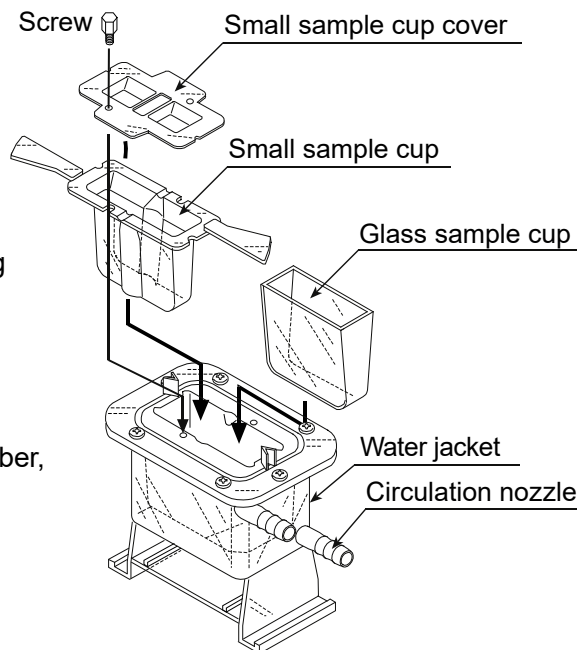

AX-SV-62-1 Dust Cover for the Measuring unit

- Used to protect the rheometer measuring unit from dust and dirt.
- Consists of :
Dust cover for the measuring unit 1 pc
(Nylon, Light gray)

Dust cover for the measuring unit

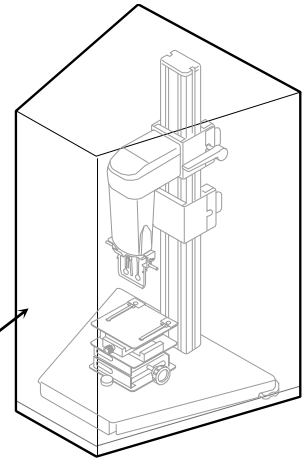

AX-SV-62-2 Dust Cover for the Display Unit and Controller

- Used to protect the rheometer display unit or controller from dust and dirt.
- Consists of :
Dust cover for the display unit and controller 1 pc
(Nylon, Light gray)

Dust cover for the display unit and controller

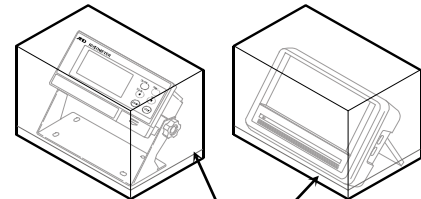

AX-SV-63 Disposable Cup (PET)

- Used in place of the small sample cup or the glass sample cup and can be disposed of after use.
- Consists of :
Disposable cup (10 mL) 40 pcs (Two bags of 20 cups each)
(Polyethylene terephthalate (PET),
Operating temperature: 80°C max.)

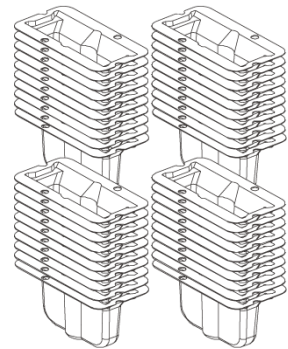

AD-1671A Anti-vibration table

- Used when the viscosity value is unstable due to external vibration, especially for measuring low viscosity.

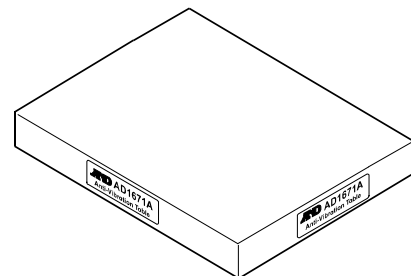

20. EXTERNAL DIMENSIONS

Main unit

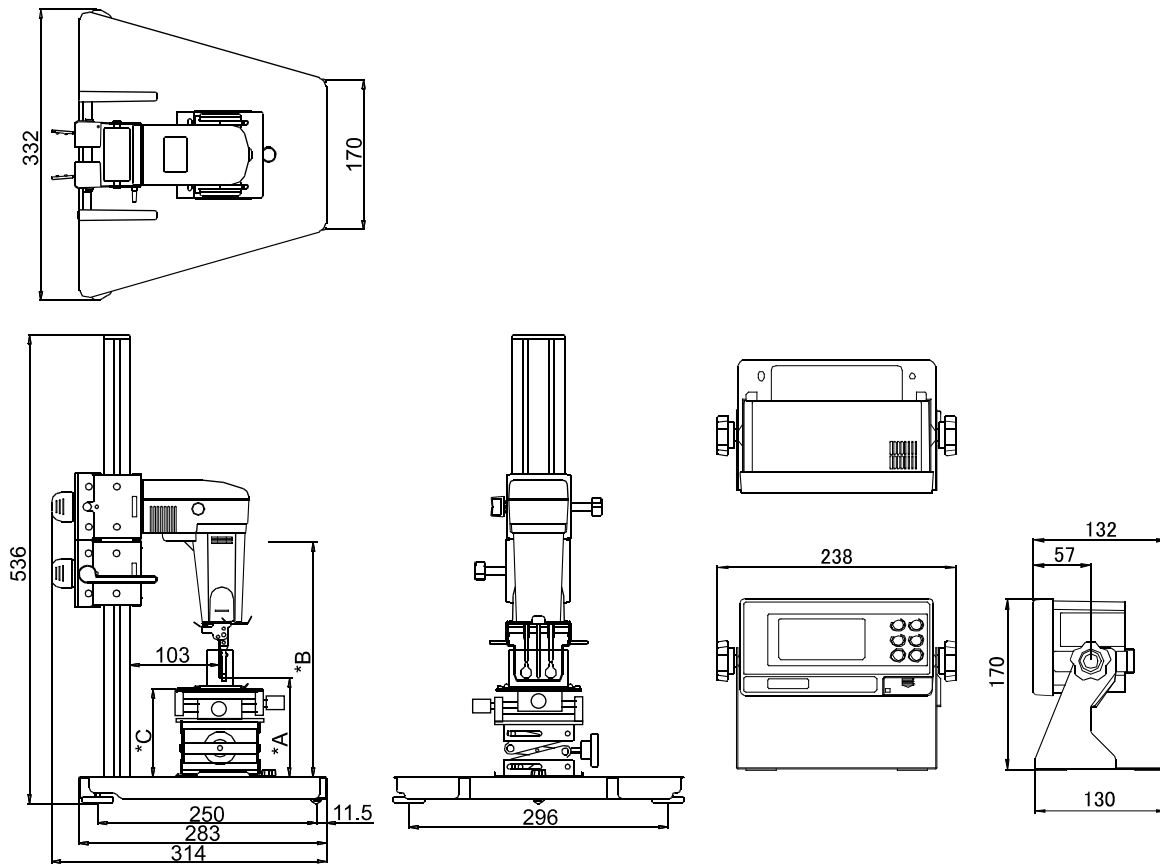

*A=Sensor plates lowest position 3.5 mm (With protector used, no table)

*B=Sensor plates highest position 268 mm

*C=Table height 54 to 140 mm

Unit: mm

Detailed View of the Sensor Unit

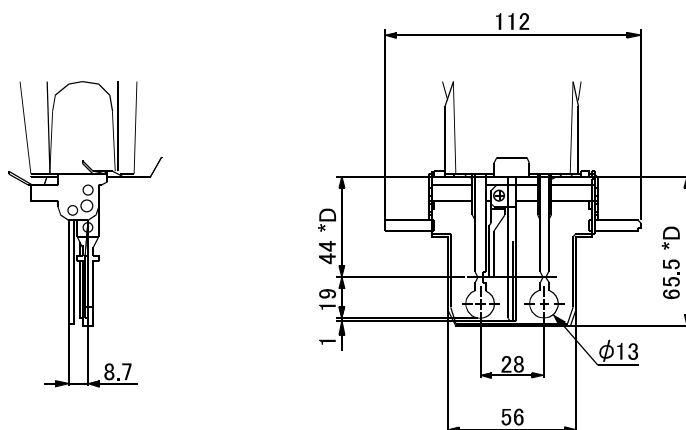

*D=Distance from the sensor protective cover

Unit: mm

Controller

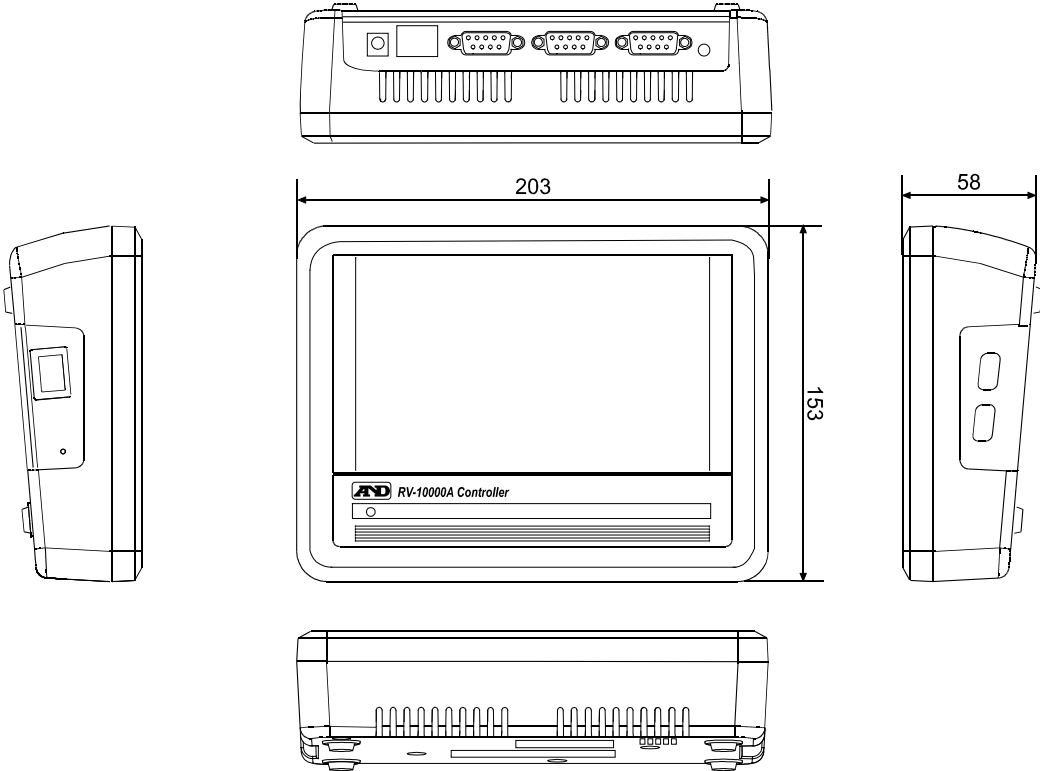

Unit: mm

THIS PAGE INTENTIONALLY LEFT BLANK.



A&D Company, Limited

3-23-14 Higashi-Ikebukuro, Toshima-ku, Tokyo 170-0013, JAPAN
Telephone: [81] (3) 5391-6132 Fax: [81] (3) 5391-1566

A&D ENGINEERING, INC.

47747 Warm Springs Blvd, Fremont, California 94539, U.S.A.
Tel: [1] (800) 726-3364 Weighing Support:[1] (888) 726-5931 Inspection Support:[1] (855) 332-8815

A&D INSTRUMENTS LIMITED

Unit 24/26 Blacklands Way, Abingdon Business Park, Abingdon, Oxfordshire OX14 1DY United Kingdom
Telephone: [44] (1235) 550420 Fax: [44] (1235) 550485

A&D AUSTRALASIA PTY LTD

32 Dew Street, Thebarton, South Australia 5031, AUSTRALIA
Telephone: [61] (8) 8301-8100 Fax: [61] (8) 8352-7409

A&D KOREA Limited

한국에이.엔.디(주)
서울특별시 영등포구 국제금융로6길33 (여의도동) 맨하탄빌딩 817 우편 번호 07331
(817, Manhattan Bldg., 33. Gukjegeumyung-ro 6-gil, Yeongdeungpo-gu, Seoul, 07331 Korea)
전화: [82] (2) 780-4101 팩스: [82] (2) 782-4264

ООО A&D RUS

ООО "Эй энд Ди Рус"

Почтовый адрес:121357, Российская Федерация, г.Москва, ул. Верейская, дом 17
Юридический адрес: 117545, Российская Федерация, г. Москва, ул. Дорожная, д.3, корп.6, комн. 86
(121357, Russian Federation, Moscow, Vereyskaya Street 17)
тел.: [7] (495) 937-33-44 факс: [7] (495) 937-55-66

A&D Instruments India Private Limited

ऐ&डी इन्स्ट्रूमेन्ट्स इण्डिया प्रा० लिमिटेड

D-48, उद्योग विहार , फेस -5, गुडगांव - 122016, हरियाणा , भारत
(D-48, Udyog Vihar, Phase-V, Gurgaon - 122016, Haryana, India)
फोन : [91] (124) 4715555 फैक्स : [91] (124) 4715599

A&D SCIENTECH TAIWAN LIMITED. A&D台灣分公司 艾安得股份有限公司

台灣台北市中正區青島東路5號4樓
(4F No.5 Ching Tao East Road, Taipei Taiwan R.O.C.)
Tel : [886](02) 2322-4722 Fax : [886](02) 2392-1794

A&D INSTRUMENTS (THAILAND) LIMITED

บริษัท เอ แอนด์ ดี อินสตรูमेंท์ (ไทยแลนด์) จำกัด
168/16 หมู่ที่ 1 ตำบลรังสิต อำเภอธัญบุรี จังหวัดปทุมธานี 12110 ประเทศไทย
(168/16 Moo 1, Rangsit, Thanyaburi, Pathumthani 12110 Thailand)
Tel : [66] 20038911