

RA2800A

Omniace III

INSTRUCTION MANUAL



1AV7001756R01

Omniace III
RA2800A
Instruction Manual



Introduction

We thank you for your purchase of our product Thermal-Dot Recorder Omnice III RA2800A. Please read this manual before operating this instrument.

This manual provides the information necessary to operate the RA2800A recorder safely. Place this manual within reach of the RA2800A. This manual covers basic functions and operations of the RA2800A and handling precautions. For operation of other functions, please refer to the separate-volume manuals listed below. If you encounter any problems in the manuals, please contact our company.

<Separate-volume manuals>

Manual	Contents
Instruction Manual Amplifier Units For RA2000A/DL2800A/DF1000A	This manual explains how to use and install amp units.

■ Before Using

● When Opening Package

If opening the package in a warm room during the cold season, open the package after it has reached room temperature to avoid any operational failure due to condensation on the surface of the product. Depending on the number of AP amplifier implementations, the unit weight may exceed 16.4 kg. When you take out from box, please handle with more than two people to prevent any drop off or to take accidental strained back.

● Examining Contents in Package

This instrument is delivered after a thorough examination at the factory prior to shipment. However, please examine the product's condition and verify that no obvious shipping damage has occurred after opening the package. Also, examine the specifications of the input units and accessories. If there are any missing or damaged items, please contact our sales representative.

Notice

- For carrying RA2800A, please hold its bottom firmly as shown right.
Incorrect holding and carrying may cause injury or damage on display or breakage of printer slot.
- Turn off the power when the operation is abnormal. If it is impossible to trace the causes of an abnormal operation, please contact our sales representative. In this case, let us know in what way the unit was operating incorrectly and what the environmental conditions are.



■ Safety Measures - Warning and Cautions

To safely use products

The RA2800A is a product conforming to the IEC standard safety class I. The recorder is manufactured with safety in mind, however, accidents may occur due to misuse by the user. To avoid such accidents, read this manual carefully before use. Observe the following warning and cautions when using the interface and remote control functions. To safely use the input units, the following statements are used in this manual to call the readers' attention.



This indicates a condition or practice that could result in personal injury or loss of life, or may result in light injury or physical damage if this equipment is misused due to neglect of a Warning.



This indicates a condition or practice that could result in light injury or damage to the equipment or other property if this equipment is misused due to neglect of a Caution.

Be sure to observe the following instructions when using this recorder. The warranty does not cover damages resulting from the actions against instructions, cautions, or warnings mentioned in this manual. Besides, there are a lot of actions that are "cannot" and "do not". It is impossible to write all such descriptions in this manual. Accordingly, assume any actions to be "impossible" except the actions explicitly described as "possible".



● Power Supply

Make sure that the power supply is within the rating indicated on the rating plate attached to this recorder. If any voltage exceeding the rated voltage were supplied, there would be risk of damage to this recorder, or even a fire.

Also, in order to prevent electric shock and hazards such as a fire, be sure to use only the AC power cable supplied with this recorder.

● Protective Grounding

Be sure to ground this recorder before supplying power. Grounding is necessary to use this recorder safely, as well as to protect the user and peripheral equipment from injury or damage. Be sure to observe the following instructions:

- 1) This recorder uses a 3-conductor AC power supply cable containing a ground lead and a 3-prong AC power plug. By plugging the power supply cable into a 3-pole AC outlet with a ground pole, grounding will be done automatically.
- 2) When grounding, do not connect the grounding lead to a water pipe, as water pipes are not necessarily conductive to the earth. Never connect the ground lead to a gas pipe either, as it is extremely dangerous.
- 3) While the power is supplied to the recorder, do not cut or remove the protective grounding line. Otherwise, safety of the recorder is not guaranteed.



- **Connection of Input Signals**

Be sure to ground the grounding terminal of this recorder before connecting to the measurement target. Also, when connecting this recorder to another measurement instrument, be careful not to exceed the maximum allowable common mode input voltage range. A voltage exceeding the range can cause damage to this recorder.

- **Use in Gaseous Atmosphere**

Never use this recorder in a flammable or explosive atmosphere, or atmosphere of steam. Use in such atmosphere will result in danger to users and the recorder.

- **Disassembling the Frame**

It is dangerous to remove the frame due to high-voltage parts inside. Do not remove the frame from the recorder other than by our service engineers.

- **Fuse at AC Power Supply Block**

The fuse for this unit cannot be replaced with the customer because this fuse is placed inside the main unit. Please contact our branches or sales offices if the fuse may be blown.

- **Handling of Back-up Battery (Cautions when Disposing)**

This recorder includes a lithium secondary battery (Lithium-ion secondary battery). When disposing this recorder, remove the lithium secondary battery in advance.

Do not dispose of it in fire or disassemble. The lithium secondary battery may explode when it is heated and organic electrolyte that may exude from it is harmful to human skin. When disposing the lithium secondary battery, isolate terminals by covering with tape and abide by your local community waste-disposal policy.

- **Disposing of your used our product**

In the European Union

EU-wide legislation as implemented in each Member State requires that used electrical and electronic products carrying the mark(left) must be disposed of separately from normal household waste. This include electrical accessories, such as chargers or AC adaptors.

The mark on the electrical and electronic products only applies to the current European Union Member States.

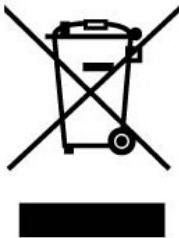

Outside the European Union

If you wish to dispose of used electrical and electronic products outside the European Union, please contact your local authority and ask for the correct method of disposal.



- **Caution in Handling**

When using this recorder, always follow the precautions below. Improper handling may lead to erroneous operations and damages.

- 1) Users who are not familiar with the operation of this recorder should avoid using it.
- 2) Storage environment
The storage temperature of the input units is -10 to 60°C (except for chart recording paper). Avoid storing in places where the temperature could rise over the storage temperature and where there is direct sunlight exposure such as inside an automobile.
- 3) Use this recorder at locations that satisfy the installation requirement, the category II (CAT II) of the safety standard for electrical measurement instruments in IEC61010-1 (JIS-C-1001-1).
- 4) This recorder is a product with a pollution degree of 2.
- 5) Do not use this recorder at the following locations. In addition, carefully check the environment when using this recorder.
 1. Locations where the temperature and humidity rise due to direct sunlight or heaters. (The operating environment of the recorder; temperature: 5 to 40°C , humidity: 35 to 80%)
 2. Wet locations
 3. Locations where salt, oil, or corrosive gases exist
 4. Damp or dusty locations
 5. Locations subject to strong vibrations
 6. Locations with a strong electromagnetic field
 7. This recorder is provided with ventilation openings in order to prevent overheating. Ensure that the ventilation openings remain unobstructed by covers or materials. Otherwise, the internal temperature of the recorder rises, causing malfunctions.
- 6) Be careful of power voltage fluctuations. Do not use the recorder when these are likely to exceed the rated voltage.
- 7) This product employs the designs that ensure the safety of users. However, there is a risk of electrical shock if you accidentally touch the object to be measured, probe, output terminal, or other parts when measuring high voltages.
- 8) If the power supply includes a lot of noise or high-voltage inductive noise, use noise filters to avoid operation errors.
- 9) A hard disk drive (HDD) is installed in this product.
 1. Please don't power off during normal operation of HDD, due to the risk of data destruction.
 2. Please have strong impact and shaking on this product, due to the risk of HDD destruction.
 3. Please use it under 5 to 40°C conditions according to the danger of HDD destruction.
- 10) This recorder uses a touch panel. When touching the panel, do not use a sharp object or push with high-pressure other than necessary. Press the panel gently with the fingertip. In addition, do not press more than one button/key at once. Be sure to press only one button/key at a time. Pressing two or more buttons/keys at once may cause misoperations.
- 11) Use the chart recording paper specified by A&D. Use of a chart that is not recommended may cause failure in printing or shorten the life of the thermal head.
- 12) If the recorder is not used for a long period of time, the internal backup battery (Lithium secondary battery) may completely discharge, causing the battery life to shorten. When the recorder is not used for a long period time, supply the recorder with power two or three times a month to charge the battery. (12 hours power-up allows battery to become fully charged.)
- 13) Do not insert a pointed or sharp object into the ventilation openings of this recorder.

- 14) To clean this recorder, first turn off the power, place it in a well-ventilated location, and wipe the recorder with soft cloth moistened with ethanol. Do not use benzene, petroleum solvents, or chemically treated cloths, as they can cause deformation or discoloration.
- 15) When transporting the recorder, use the package and packaging material supplied at factory shipment, or use a package and packaging material more shock-resistance than those supplied.
- 16) For carrying RA2800A, Do not hold plastic panel of the front Put your hand from sides and hold its bottom firmly. Incorrect way of carrying may cause injury or damage on display or breakage of printer slot.
- 17) We recommend a periodical calibration to maintain the accuracy of the input units. More reliable measurements are possible by calibrating the input units once a year (extra cost option).

■ Warranty - General

We ship our products after conducting quality control, which covers from design to manufacturing. It is, however, possible that failures may occur in the products. If the product does not operate correctly, please make a check of the power supply, cable connections, or other conditions before returning this product to us. For repair or calibration, contact our sales agency. Before returning, be sure to inform us of the model (RA2800A), serial number, and problematic points. The following is our warranty.

■ Limited Warranty

1. Warranty period

One year from our shipment.

2. Warranty period

We will repair the defects of our product free of charge within the warranty period; however, this warranty does not apply in the following cases.



- (1) Damage or faults caused by incorrect use.
- (2) Damage or faults caused by fire, earthquake, traffic accident, or other natural disasters.
- (3) Damage or faults caused by a repair or modification that is carried out by someone other than a service representative of A&D.
- (4) Damage or faults caused by use or storage in environmental conditions that should be avoided.
- (5) Periodical calibration.
- (6) Damage or faults caused during transportation.

3. Liability

We do not assume any liabilities for equipment other than A&D.

■ Terms and Symbols in This Manual

Terms and symbols used in this manual denote as follows.

Terms and Symbols	Description
 WARNING	This indicates a condition or practice that could result in personal injury or loss of life, or may result in light injury or physical damage if this equipment is misused due to neglect of a Warning.
 CAUTION	This indicates a condition or practice that could result in light injury or damage to the equipment or other property if this equipment is misused due to neglect of a Caution.
NOTE	This indicates a condition or practice that could result in incorrect operation or damages in data if this equipment is misused due to neglect of Note.
TIPS	This symbol gives setting restrictions and additional descriptions.
	Reference page
This recorder	RA2800A
[]	Characters enclosed by brackets represent a key name in the operation panel.
Memory	Internal memory of RA2800A When measuring with memory recorder or transient recorder, measured data is recorded in this memory.
k (lower case) K (upper case)	A unit of numerical value "k" is used to represent 1000 such as "10 kg". "K" is used to represent 1024 such as "4 K data"

■ Liquid Crystal Display

This recorder has a TFT color LCD for display. There may be cases where the light of pixels does not come on or off in the LCD. In addition, the LCD includes unevenness slightly due to temperature changes. Please be aware that these cases are not disorders.

◆ Handling of back-up batteries (Cautions for disposition)

This product uses manganese dioxide lithium batteries (primary battery). **Please take the batteries out when disposing this product.**

Please do not put batteries into fire or disassemble. Heating up batteries may cause explosion. Also it is extremely dangerous to disassemble batteries; organic electrolyte contained inside may spill out and cause damages to your skin or other parts of your body. When disposing batteries, please put tapes around end terminals to insulate and dispose as unburnable trash.

■ Overview of Windows XP Embedded

This product employs Windows XP Embedded as the OS. Please read and understand the following instructions carefully before use.

(1)License

The Windows XP Embedded is provided as built-in only license. This product cannot function as general purpose PC, it is limited exclusively for RA2800A use. Duplication of installed system of this product is not allowed be used.

(2)Power ON/OFF

Please make sure that HDD is not being accessed before turning the power off. If the power is turned off while HDD is being accessed, not only it may cause damage to data recorded on the HDD but also it may fatally damage the HDD machine itself to unusable condition. To confirm that HDD access has been stopped before turning the power off, please press EXIT on System button to stop the system, then turn off the power. When exit command is being processed, it does not leave record of starting or set ups in registry. OS will always start up in the condition set at the time of factory shipment. (Set values are saved under separate file and will not be lost.)

(3)Virus

We take following measures in order to lower the possibilities of virus infections.

- **Mailing function is not provided.**

- **System protect with light filter.**

System drive, which contains OS and other applications, cannot be overwritten; normally those will not be affected under any condition, however, if internal HDD has been accessed as a shared file on network system, it is possible that files saved in HDD will be infected by viruses. In case there are possibilities that virus-infected files are saved in HDD, please eliminate the virus by going through the following procedures. If other PCs connected to the same network access the subject file, the PC could become the source of infection. Please set up one to one network environment and run anti-virus software from a PC targeting the HDD of this product in order to check and eliminate viruses. Anti-virus software cannot be installed directly to this product.

(4)Network use

When connecting this product with network, please consider not interrupting any device or PC through the network by consulting network administrator. (Transmit ion of higher volume of data would cause slow data transfer due to higher network traffic)

(5)USB compatible devices

Devices that are compatible for this product are limited by default setting. It works differently than Windows on PCs, and it is not possible to install additional device drivers. Compatible devices for this product are limited to the devices listed below. Please do not connect other devices. Other devices are not subject of our guarantees.

-USB memory (The USB memory with a security function cannot be used.)

(6)Maintenance

Please use these application program files provided by our company for version-ups and run those programs from system menu.

(7)Others

We do not assumes any responsibility or provide support for malfunctions if programs that are not provided by us are installed into the system or compulsory termination command is used through external keyboard and such.

Windows, Windows XP, Windows XP Embedded are trademarks or registered trademarks of Microsoft Corporation in US and other countries.

CONTENTS

Introduction	1
■ Before Using	1
■ Safety Measures - Warning and Cautions	2
■ Warranty - General	5
■ Limited Warranty	5
■ Terms and Symbols in This Manual	6
■ Liquid Crystal Display	6
■ Overview of Windows XP Embedded	7
1. RA2800A Overview	1-1
1.1. Basic Specifications	1-2
1.1.1. <i>Overview and features</i>	1-2
1.1.2. <i>Features</i>	1-2
1.2. Configuration	1-3
1.2.1. <i>Model</i>	1-3
1.2.2. <i>Recorder and Amp Unit</i>	1-3
1.2.3. <i>Standard Accessories (Display in Japanese and 100VAC)</i>	1-3
1.2.4. <i>Other Accessories and Consumables</i>	1-4
1.2.5. <i>Other Optional Equipment</i>	1-4
1.2.6. <i>Special Software</i>	1-4
2. Name and Function of Each Block	2-1
2.1. Overview of Blocks	2-2
2.2. Display Block	2-3
2.3. Operation Panel	2-4
2.4. Rear Block	2-6
3. Pre-measurement Procedures	3-1
3.1. Before Switching on the Power	3-2
3.1.1. <i>Usage Environment</i>	3-2
3.1.2. <i>Before Connecting AC Power Cable</i>	3-2
3.1.3. <i>AC Power Cable</i>	3-3
3.2. Paper Loading	3-4
3.2.1. <i>Paper Roll</i>	3-4
3.2.2. <i>Loading z-fold paper</i>	3-6
3.3. Insert the Amp Unit	3-9
3.4. Turning on the Power	3-10
4. Operation Flow	4-1
4.1. Operation Flow	4-2
4.2. Making Basic Settings	4-3
4.2.1. <i>Explanation of Basic Screen Settings</i>	4-3
4.2.2. <i>Explanation of setting keys</i>	4-4
4.2.3. <i>Explanation of standard setting windows</i>	4-6
5. Input Signal Monitor	5-1
5.1. Observing Input Signals	5-2
5.2. Displaying Input Waveform Monitor	5-3

6. Auto Setup	6-1
6.1. Function Overview	6-2
6.2. Auto Range	6-2
6.3. Auto Sampling	6-3
6.3.1. Target Setup Conditions	6-3
6.3.2. Adjustment Range	6-3
7. Amp Units	7-1
7.1. Settings for Input Units	7-2
7.1.1. Amp Basics Screen	7-2
7.1.2. Amp Details Screen	7-3
7.1.3. Recorder Event Detailed Screen	7-4
7.1.4. Conector /Pin Alignment	7-5
7.1.5. Restriction of Printing in Event Amp	7-6
8. Pen Recorder	8-1
8.1 Overview of Pen Recorder Mode	8-2
8.2. Screen Operation	8-3
8.3. Printing Operation	8-4
8.3.1. Stop Due to Error	8-5
9. Memory Recorder	9-1
9.1. Overview of Memory Recorder Mode	9-2
9.2. Recording Condition Setup	9-3
9.2.1. Description of Icons	9-3
9.2.2. Memory Recording Condition Setup Block	9-4
9.3. Recording Operation	9-7
10. HD Recorder	10-1
10.1. Overview of HD Recorder Mode	10-2
10.2. Recording Condition Setup	10-3
10.2.1. REC Icon	10-3
10.2.2. HD Recording Setup Block	10-4
10.3. Recording Operation	10-7
10.3.1. Start of Measurement	10-7
10.3.2. To Finish Measurement (Forced Termination)	10-7
10.3.3. Waveform Chart Printing	10-7
10.3.4. Upon Error Generation	10-7
10.3.5. Display of recording data	10-7
10.4. HD Recording Specifications	10-8
10.4.1. Recording File Size Calculation	10-8
10.4.2. Recording Speed Execution Restriction	10-8
11. Multi Recorder	11-1
11.1. Overview of Multi Recorder Mode	11-2
11.2. Recording Condition Setup	11-3
11.2.1. REC Icon	11-3
11.2.2. Multi Recorder - Setup for Recording Condition	11-4
11.3. Recording Operation	11-6
11.3.1. Error Generation	11-6

12. X-Y Recorder	12-1
12.1. Overview of X-Y Recorder Mode.....	12-2
12.2. Screen Operation.....	12-3
12.3. Printing Operation.....	12-6
12.3.1. Restrictions during X-Y Printing.....	12-6
12.3.2. Exception (Error).....	12-6
13. Trigger Settings.....	13-1
13.1. Trigger Mode Description	13-2
13.1.1. Trigger Mode - Operation at OR.....	13-2
13.1.2. Trigger Mode - Operation at AND.....	13-2
13.1.3. Trigger Mode - Operation at WINDOW.....	13-3
13.1.4. Trigger Mode - Operation at OFF.....	13-3
13.2. Manual Trigger/External Trigger.....	13-4
13.2.1. Manual Trigger.....	13-4
13.2.2. External Trigger (TRIG IN).....	13-4
13.2.3. External Trigger Output (TRIG OUT).....	13-4
13.2.4. External Trigger Input/Output Circuit.....	13-5
13.3. Method of Trigger Settings	13-6
13.4. Settings by Trigger Mode	13-7
13.4.1. Trigger Mode OR.....	13-7
13.4.2. Trigger Mode AND.....	13-7
13.4.3. Trigger Mode WINDOW.....	13-8
13.4.4. Trigger Mode OFF.....	13-8
13.5. Trigger Filter	13-9
13.5.1. Trigger Filter.....	13-9
13.6. Trigger Settings for Event Amp.....	13-10
13.7. Trigger Settings for Event unit.....	13-11
14. Replay Display.....	14-1
14.1. Overview of Replay Monitor.....	14-2
14.2. Replay Data Selection	14-3
14.3. Waveform Display Region.....	14-4
14.3.1. Shift of Waveform Display Region.....	14-4
14.3.2. Shift of Cursor Position.....	14-5
14.4. Digital Indication	14-5
14.4.1. Digital Indication.....	14-5
14.4.2. Cursor Display Information.....	14-5
14.4.3. Digital Indication Switching.....	14-5
14.5. Signal Settings	14-6
14.6. Jump	14-7
14.6.1. Basic Jump.....	14-7
14.6.2. Time Jump.....	14-7
14.6.3. Address Jump.....	14-7
14.6.4. Maximum/Minimum Search & Jump.....	14-8
14.6.5. Event Jump.....	14-9
14.7. Time Axis Magnification.....	14-9
14.8. Output Setup.....	14-10
14.8.1. Specifying Output Time Range.....	14-10
14.8.2. Specifying File Save Format.....	14-10
14.8.3. Specifying CSV Delimiter	14-10
14.8.4. Specifying Number of Skip in CSV	14-11
14.8.5. Specifying File Save Destination.....	14-11
14.8.6. Execution of Data Output	14-11

14.9. Copy	14-11
14.10. X-Y Waveform Display	14-12
15. Display and Printing	15-1
15.1. Settings for Display and Printing	15-2
15.1.1. <i>Monitor Display</i>	15-2
15.1.2. <i>Display</i>	15-3
15.2. Print Setting	15-4
15.2.1. <i>Print to ON or OFF</i>	15-4
15.2.2. <i>Print Setting</i>	15-5
15.3. Annotation Setting	15-6
15.4. Digital value representation Setting	15-7
16. System Setup	16-1
16.1. Commonly Used System Screen	16-2
16.1.1. <i>Termination</i>	16-2
16.1.2. <i>USB Drive Disconnection</i>	16-2
16.2. Measurement Mode	16-3
16.2.1. <i>Screen Display upon Startup</i>	16-3
16.2.2. <i>Measurement Mode</i>	16-3
16.2.3. <i>Setup Value Save</i>	16-4
16.2.4. <i>Initialize</i>	16-4
16.3. File Operations	16-5
16.3.1. <i>Copy</i>	16-6
16.3.2. <i>Delete</i>	16-7
16.3.3. <i>Create Folder</i>	16-7
16.3.4. <i>Save Memory</i>	16-8
16.3.5. <i>Save Env</i>	16-9
16.3.6. <i>Read</i>	16-9
16.4. Recording Settings	16-10
16.4.1. <i>Recording Channels</i>	16-10
16.4.2. <i>Data No. Setting</i>	16-10
16.4.3. <i>Recording Speed Table</i>	16-11
16.4.4. <i>Timer Recording Settings</i>	16-11
16.5. Communication Settings	16-13
16.6. Auxiliary Settings	16-15
16.6.1. <i>Buzzer/Clicking Sound</i>	16-15
16.6.2. <i>Auto Display Light-off</i>	16-15
16.6.3. <i>Screen Copy Output Destination</i>	16-15
16.6.4. <i>Key lock Password Settings</i>	16-16
16.6.5. <i>Mouse cursor</i>	16-16
16.7. Maintenance	16-17
16.7.1. <i>Version Indication</i>	16-17
16.7.2. <i>Test Print</i>	16-18
16.7.3. <i>Data Printing</i>	16-18
16.7.4. <i>Time Calibration</i>	16-18
16.7.5. <i>Maintenance mode</i>	16-18

17. How to Use Optional Units.....	17-1
17.1. Connecting optional units.....	17-2
17.2. Remote Unit (RA23-144).....	17-3
17.2.1. Overview.....	17-3
17.2.2. Connector/Pin Location.....	17-3
17.2.3. To Synchronize to External Pulse and Perform Waveform Chart Printing and Printing ..	17-4
17.2.4. Memory Acquisition Using External Sampling.....	17-5
17.2.5. Start/Stop recording (Start/Stop button).....	17-5
17.2.6. Chart Feed.....	17-5
17.2.7. Mark Printing.....	17-6
17.2.8. Protecting File Data (UPS DOWN).....	17-6
17.2.9. Monitoring errors on recording areas.....	17-6
17.2.10. Parallel Operation.....	17-6
17.3. RS-232C Unit (RA23-142).....	17-7
17.3.1. Names of each parts and their functions	17-7
17.4. AC Bridge Excitation unit (RA23-143).....	17-8
17.4.1. Names of each parts and their functions.....	17-8
17.4.2. Set up for Synchronization.....	17-8
18. Maintenance and Cleaning	18-1
18.1. Handling and Storing Recording Paper and Data	18-2
18.1.1 Storing the Recording Paper	18-2
18.1.2 Caution for Handling and Storage of Recorded Data.....	18-2
18.2. Battery Backup	18-2
18.3. Cleaning the Display.....	18-2
18.4. Cleaning and Preserving the Thermal Head.....	18-3
18.4.1. Cleaning.....	18-3
18.4.2. Life	18-3
18.5. Platen Roller Storage	18-3
18.6. Dealing with Power Outages, etc.....	18-3
18.7. Cautions When Disposing of This Instrument	18-3
19. Troubleshooting.....	19-1
19.1. Troubleshooting and Inspection	19-2
19.2. Frequently Asked Questions (Q&A).....	19-3
20. Specifications.....	20-1
20.1. Configuration.....	20-2
20.1.1. Model	20-2
20.1.2. Main Unit/Amp Unit.....	20-2
20.1.3. Standard options (Japanese version/100VAC system)	20-2
20.1.4. Options and Consumables.....	20-3
20.1.5. Other Options.....	20-3
20.1.6. Special Software	20-3
20.2. Basic Specifications.....	20-4
20.2.1. Recorder Unit Specifications	20-4
20.2.2. Recording Function.....	20-5
20.2.3. Amp Unit Function.....	20-5
20.2.4. Trigger Function	20-6
20.2.5. File Function.....	20-7
20.2.6. Monitor displaying and setting function.....	20-8
20.2.7. Monitor Output.....	20-8

20.3. Specifications by each measurement mode	20-9
20.3.1. <i>Memory Recorder mode</i>	20-9
20.3.2. <i>HD Recorder Mode</i>	20-10
20.3.3. <i>Pen Recorder Mode</i>	20-10
20.3.4. <i>X-Y Recorder Mode</i>	20-10
20.3.5. <i>Multi Recorder mode</i>	20-11
20.4. Recorder Event	20-12
20.5. Acquisition Data Output	20-13
20.6. Standard Function	20-13
20.7. Interface	20-13
20.7.1. <i>LAN (Standard)</i>	20-13
20.7.2. <i>USB (Standard)</i>	20-13
20.7.3. <i>TRIG IN/TRIG OUT (Standard)</i>	20-13
20.8. Remote Unit (RA23-144:Optional)	20-14
20.9. RS-232C Unit (RA23-142:Optional)	20-15
20.10. AC Bridge Power Supply Unit (RA23-143:Optional)	20-15
20.11. English Display Unit (RA23-106: Optional, specified at ordering)	20-15
20.12. Dimensions of RA2800A	20-16
20.12.1. <i>Dimensions of RA2800A Standard Unit</i>	20-16
20.12.2. <i>Option Unit Outline Drawing</i>	20-17
21. Cables·Probes·Spare Parts List	21-1
21.1. Cables List	21-2
21.2. Probes·Clamp Meter List	21-6
21.3. Spare Parts List	21-6

1. RA2800A Overview

1.1. Basic Specifications

1.1.1. Overview and features

A2800A is the product based on the concept of Simple Measurement for anyone at anywhere. New features such as the dynamic waveform view on a large display and the visualized amp setting screen provide simple operation for Pen Recorder users to make quick measurement. In addition; built-in large-capacity HD and memory enable a long continuous recording with multi channels.

● Configuration

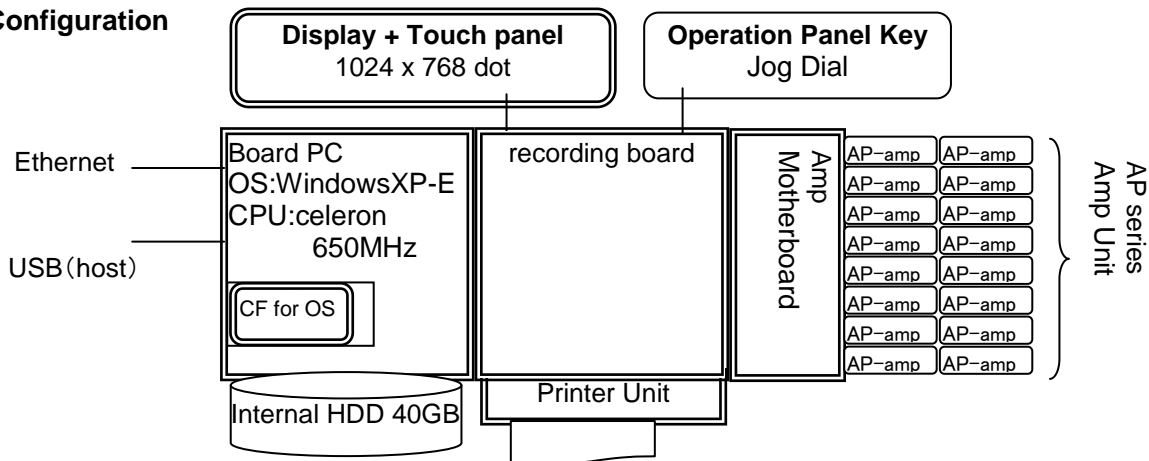

1.1.2. Features

● Simple Pen Recorder mode

Visualized amp setting screen and touch panel provide simple operation like Pen Recorder. This mode allows you to make a measurement as easily as Pen Recorder without complicated settings.

● Long-time HD recording

Built-in HDD (40GB) enables long-time recording of data at a high speed. This HDD has enough space for 120 days recording at 10ms speed with 32 input channels.

● Waveform display on a large display

The 12.1 inches LCD display is adopted for better visibility of measuring data. The 32 ch waveforms can be dynamically displayed.

● Various choices for measurement mode

Five measurement modes are provided such as Pen Recorder enabling a pen recorder-like operation, HD Recorder enabling long time recording, and X-Y Recorder displaying input signals with 1ch in the X-axis direction and 3ch in the Y-axis direction. This allows you to choose an appropriate function according to your purpose.

● Standard Ethernet and UEB interface

Ethernet (100BASE-T) for data communication and USB for storage devices (USB memory are equipped.)

● Auto functions

Pushing the Auto button on the operation panel automatically adjusts recording/recording speeds and amp sensitivity for measurement of input signal under optimum conditions.

● Compatibility with AP amp series

Compatibility with AP amp series of RA1000 and DL2000 is supported. This allows RA1000 and DL2000 users to concurrently use their AP amp series to make a measurement at low cost.

● AP amp unit

Eight units from 11 types of amp units can be selected according to measurements. Each amp unit supports an isolation input so that a unit can be easily replaced with another unit.

1.2. Configuration

1.2.1. Model

The recorder comprises the main recorder unit, amp units, optional units, and standard accessories.

Product name	Model	Remark
Omniace III	RA2800A	Command displays can be chosen to be English or Japanese when placing an order.

1.2.2. Recorder and Amp Unit

Name		Configurat ion	Remark
Main body	Recorder body (Operation block, display block, amp insertion block, control block)	1	•USB port x 2 •Ethernet port x 1
	Built-in printer	1	
	Power supply (90 to 240 VAC)	1	
	Remote unit	Optional	RA23-144
	RS-232C unit	Optional	RA23-142
	AC bridge power supply unit	Optional	RA23-143
Amp unit	Unit name	Type No.	Abbreviated name
	2CH High-Resolution DC Amp Unit	AP11-101	HRDC
	2CH FFT Amp Unit	AP11-102	FFT
	2CH High-Speed DC Amp Unit	AP11-103	HSDC
	2CH AC Strain Amp Unit	AP11-104A	ACST
	Event Amp Unit	AP11-105	EV
	2CH TC/DC Amp Unit	AP11-106A	TCDC
	TC/DC Amp Unit	AP11-107	TDC
	F/V Converter Unit	AP11-108	FV
	2CH Vibration/RMS Amp Unit	AP11-109	RMS
	2CH DC Strain Amp Unit	AP11-110	DCST
	2CH Zero Suppression	AP11-111	HRZS

1.2.3. Standard Accessories (Display in Japanese and 100VAC)

Name	Type No.	Rating	Quantity
AC power supply	0311-5044	100VAC, 2.5m	1
Users manual	7001756-R01	For recorder	1
Users manual	7006462-R01	For amp unit	1
Recording chart paper holder	8247-4310	1 piece for each of roll chart	2
Recording chart paper	0511-3167	Roll chart 219.5 mm x 30 m	1
Blank panel for amp	37137-7002-0000		16 (Attached blank panels to body is also included)
Blank panel for interface	38410-2416-0000	2 screws per blank panel	3 (Attached blank panels to body is also included)
Empty for AC strain OSC	38410-2417-0000	2 screws per blank panel	1 (Attached a blank panel to body is also included)

1.2.4. Other Accessories and Consumables

(1) Accessories for event unit (AP11-105)

Name	Type No.	Remark
Logic IC cable	0311-5007	2 cables per unit
IC clip cable	0311-5008	4 cables per bag, 2 bags per unit
Alligator clip cable	0311-5009	4 cables per bag, 2 bags per unit

(2) Accessories for remote unit (RA23-144)

Name	Type No.	Remark
Remote cable	00311-5251-0000	1 cable per unit

(3) Consumables

Name	Type No.	Rating
Recording chart paper	YPS106	Roll chart paper, 219.5 mm x30 m, 5 volumes per box
Recording chart paper	YPS108	Roll chart paper, 219.5 mm x30 m, 5 volumes per box With 300-mm pitch perforated line Remaining length indication print pitch: 300mm 99 to 01
Recording chart paper	YPS112	Z-fold paper, 219.5 mm x 200 m, fold width: 300 mm Remaining length indication print pitch (pages): 669 to 000 Note: Supply case (RA12-103) is required for Z-fold paper
Recording chart paper	YPS114	Roll chart paper, 219.5 mm x100 m, 2 volumes per box

1.2.5. Other Optional Equipment

Name	Type No.	Remark
Carrying box	RA28-113	With caster
Dust cover	RA28-114	Dustproof vinyl cover
Cart (push car)	RA28-116	
Paper take-up	RA28-119	External rewinder
Storage case	RA28-115	
Fixing bracket for racks	RA28-117	JIS rack
Fixing bracket for racks	RA28-118	EIJ rack

1.2.6. Special Software

Name	Model	Note
Unifizer	NS3100-P01	This software enables connecting a PC to RA2800A via Ethernet cable for remote control such as data acquisition, various setups, and record starting.

2. Name and Function of Each Block

2.1. Overview of Blocks

The RA2800A consists of the following blocks.

Front view

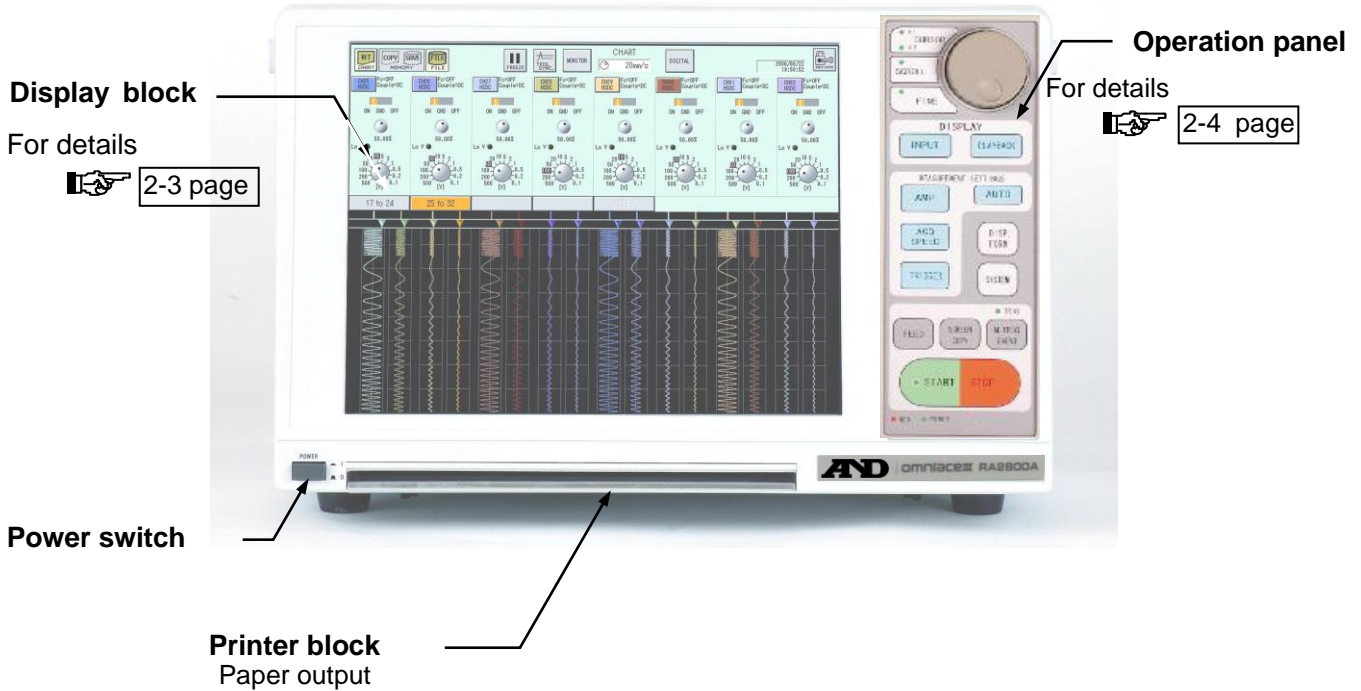

Rear view

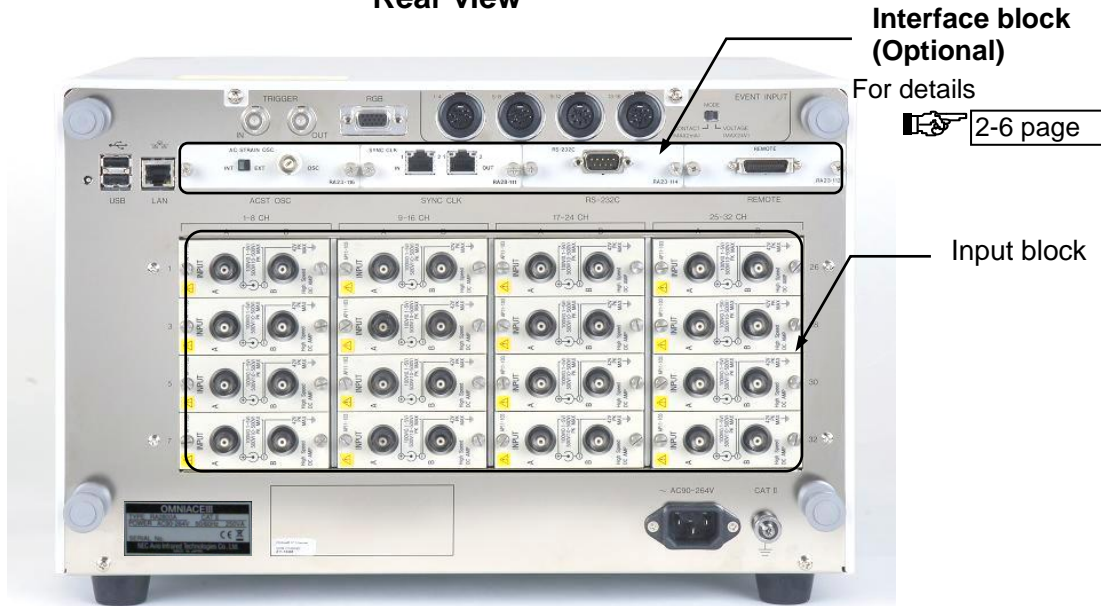

2.2. Display Block

The RA2800A has TFT color LCD with touch panel. This LCD displays screen for setup and user can make settings by touching the setting items that is displayed on the LCD.

Turn on the recorder that has the factory default settings. The following screen appears. The contents for amplifiers differ depending on the amplifiers that are installed.

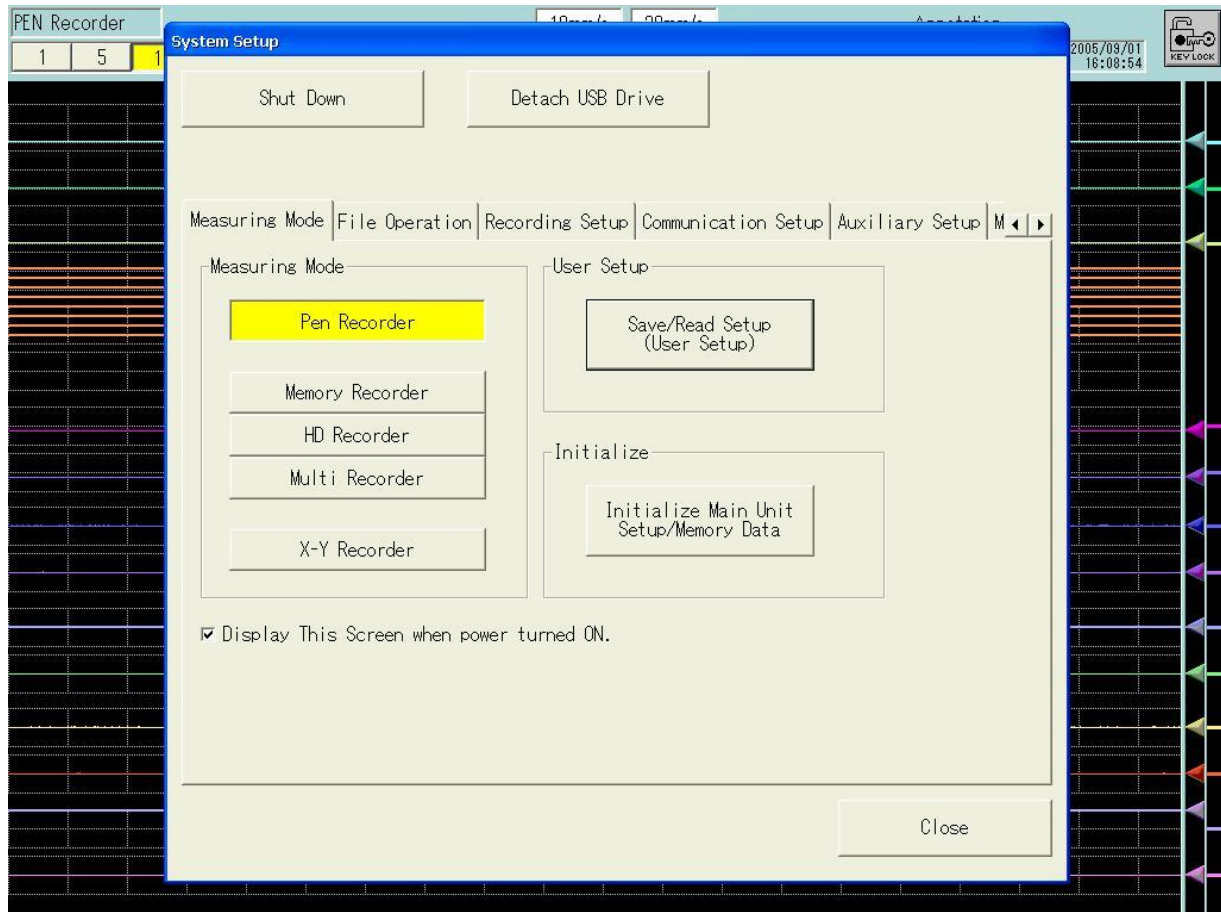

The buttons on the operation panel switches the screen display; the touch panel buttons on a displayed panel makes settings for input units, recording conditions, acquisition, and triggers. The conditions of the signals that are input can be observed on the display.

NOTE

There may be few dots that always illuminate or do not illuminate on the display or slight brightness unevenness on the display. These phenomena are not defects.

2.3. Operation Panel

This section explains button functions on the operation panel block.

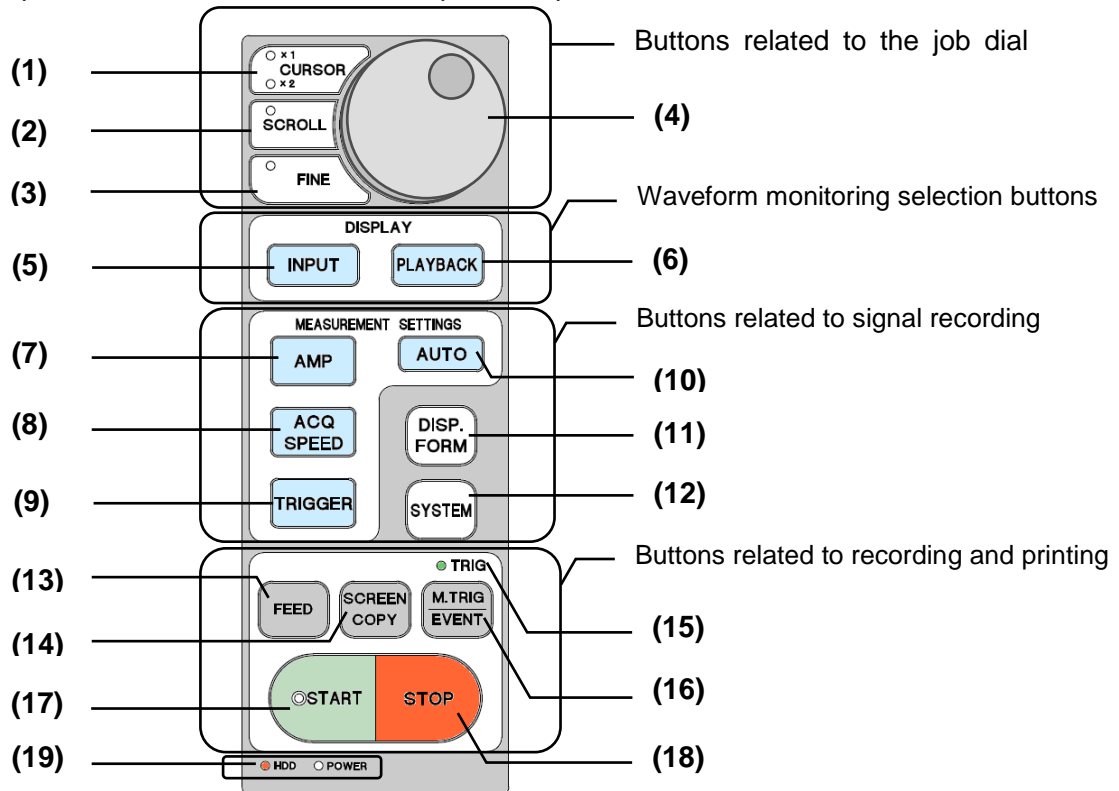

◆ Buttons related to jog dial

(1) Cursor X1/X2: Switching between cursors X1 and X2

This button is used to switch between cursors X1 and X2. The cursor whose LED comes on can be moved through the touch panel or jog dial.

(2) Scroll: Scrolling displayed waveform

This button is used to scroll the waveform. After this button is pressed, LED above comes on, and then scrolling can be made with scroll bar on the touch panel and jog dial.

(3) Fine Tuning: Controlling movement speed of cursor and scroll

This button is used to change the scrolling speed for cursor or waveform. This change is made by changing values on the screen.

(4) Jog dial: Continuous value changes, cursor movement on the monitor, and waveform scrolling

Value can be continuously changed by rotating the jog dial. On the replay monitor, smooth cursor movement and waveform scrolling can be made.

◆ Waveform selection button

(5) Input Signal: Displaying input signal on the monitor

The input monitor screen, which has blue background, offers real-time observation of input signals in the form of digital value or waveform.

(6) Replay: Replay of recorded data

The replay monitor screen, which has gray background, offers replay and observation of the data stored in memory, internal HDD, and external media. Replay format can be selected from among waveform, value, and X-Y.

◆ Buttons related to recording**(7) Amp: Displaying the amp screen**

Setting for amp units such as range and input ON/OFF can be made.

(8) Recording conditions: Setting recording speed

Settings for recording such as sampling speed, chart feed speed, pre-trigger settings are made.

(9) Trigger: Displaying trigger screen

Settings for trigger conditions such as trigger level selection, trigger level setup, and trigger conditions.

(10) Auto: Automatic operation settings

Auto makes automatic settings for analog amp range and recording speed.

(11) Display/Printing: Settings for data display on the monitor and printing on the chart paper

Printing and display format can be set.

(12) System: Displaying system screen

The following settings are available: Measurement mode that decides measurement method, Maintenance that sets date, RS-232C, LAN, and Communication that sets remote.

◆ Buttons related to recording and printing**(13) Chart Feed: Feeding chart recording paper**

While this button is pressed, chart recording paper is fed.

(14) Screen Copy: Hard copy for screen

Pressing this button makes hard copy for the current screen. The output media (paper or bitmap file) can be designated in the system settings.

(15) Trigger: Trigger LED

LED comes on when the trigger is generated.

(16) Marking/Manual Trigger: Adding mark indication on printing or manually triggering

Mark indication such as time can be added to printing. Measurement can be started by manual trigger.

(17) Start: Starting measurement

Pressing this button starts measuring. The LED of the button blinks during the measurement.

(18) Stop: Halting operation

Pressing this button halts the measurement or operations such as screen hardcopy.

(19) HDD/POWER: LED

HDD: LED blinks when the internal HDD is accessed.

POWER: LED blinks immediately after power-on.

2.4. Rear Block

Up to eight optional amps can be installed in this block.

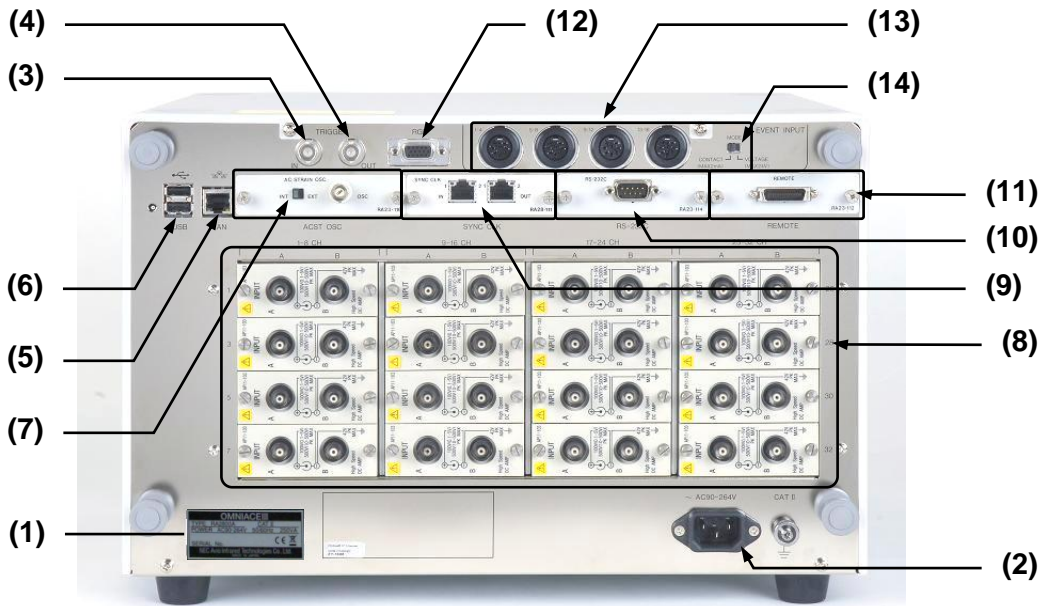

(This is an example that installs sixteen 2CH High-Speed DC Amp Units)

(1) Faceplate

Power voltage input range and power dissipation is indicated.

(2) AC socket

AC power cable is connected to the socket.

The Main Power Switch is the push button at the bottom left of the front panel.

Push down for power ON (button dented), and push again for power OFF (button protruding).

(3) TRIG IN

This terminal is used to enter an external trigger signal when input signal level is not used as a trigger source.

(4) TRIG OUT

This terminal is used to synchronously operate other instruments by outputting trigger signal. Additionally, signal from this terminal is used to monitor the status of the trigger.

(5) LAN

This is a connector for LAN connection.. This connector is useful when a communication between personal computers is made.

(6) USB

This is a USB connector. Memory devices such as USB memory or external drives can be connected.

(7) AC bridge power switch (INT/EXT)/OSC terminal

This is INT/EXT switch for AC bridge power unit (RA23-143, optional) and OSC terminal.

This is needed when you use AC strain amplifier (AP11-104A).

NOTE

When you setup EXI, AC bridge synchronous power signal should be connected to OSC terminal. When you setup INT, all other instruments connected to OSC terminal should be set to EXT. In either the case, wrong settings may prevent the recorder from correct measurement and cause failure.

(8) Input block

Up to optional eight amps can be installed.

(9) SYNC UNIT

Use the Synchronization Unit (RA28-132: optional) for parallel and synchronized sampling with multiple RA2800As.

(10) RS-232C

RS-232C unit (RA23-142, optional) is inserted in this portion. Connection to external machines such as the host computer is made.

(11) REMOTE

Remote unit (RA23-144, optional) can be inserted in this portion. Start or stop for recording/printing, feed, marking, or synchronous operation can be made.

(12) XGA Monitor Output

This function outputs the screen same as that rendered on the display to the XGA monitor (Analog RGB, 1024 x 768 dots).

(13) Main Unit Event Input

This block is 16-input event. The input connector is divided into four segments (1-4, 5-8, 9-12, 13-16).

(14) Main Unit Event Input Level Switch

Using this slide switch the judgment switches between contact input level and voltage input level for 16 input collectively.

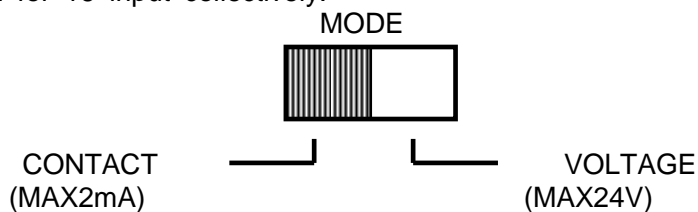

3. Pre-measurement Procedures

3.1. Before Switching on the Power

The preparations for using this recorder and the cautions are explained below.

3.1.1. Usage Environment



CAUTION

Cautions regarding the installation site.

- Use this recorder on a flat surface.
- Use this recorder in a place that meets the requirements of Installation Category II (CAT II) of the Safety Standards for Electrical Measurement Instrument, JIS-C-1010-1(IEC61010-1).
- Use this recorder in a place with **an ambient temperature between 5 and 40°C and humidity between 35 and 80% RH**
- This recorder has a pollution factor of 2
- Use this recorder in a sufficiently safe environment, taking care to avoid use in the following places.
 - (1) **Places with excessive humidity due to exposure to direct sunlight or proximity to heating fixtures**
 - (2) **Damp or wet place**
 - (3) **Places with salty, oily or gaseous atmosphere**
 - (4) **Humid or dusty place**
 - (5) **Places subject to strong vibration or shock**
 - (6) **Places subject to voltage surges due to an electromagnetic field**
 - (7) **To protect from an excessive internal temperature, this recorder is provided with ventilation holes. These holes must under no circumstances be obstructed by surrounding objects, as an excessive internal temperature may cause damage to the recorder.**
 - (8) **Do not place paper or other flammable materials near this recorder.**

3.1.2. Before Connecting AC Power Cable

Be sure to check the following points before connecting the AC power cable to this recorder.

- **The power supply switch (POWER) of this recorder must be OFF.**
- **The power supply must comfort to the rating specified on the rating plate.**
- **Ensure amp or interface units are inserted.**



Power is turned on or off from the front.

Rating plate



This recorder must be grounded before power is applied.

This grounding protection is for the safety of this recorder, as well as for that of the user and peripheral equipment.

- If AC power cable that comes with this recorder is connected to a 3-pin power outlet equipped with a protective conductor pin, the recorder is automatically grounded.

3.1.3. AC Power Cable

The AC power cable that is included in this recorder (0311-5044: 100-VAC system, 2.5 m) is a 3-pin type which has the round pin at the center for protective grounding.

3.2. Paper Loading

Load either a paper roll or z-fold paper into this recorder.

3.2.1. Paper Roll

(1) Attach the paper holders to the paper roll.

Attach a paper holder to both ends of the paper roll. If loading a partially used roll, trim the edges for ease of loading, as shown in the figure below.

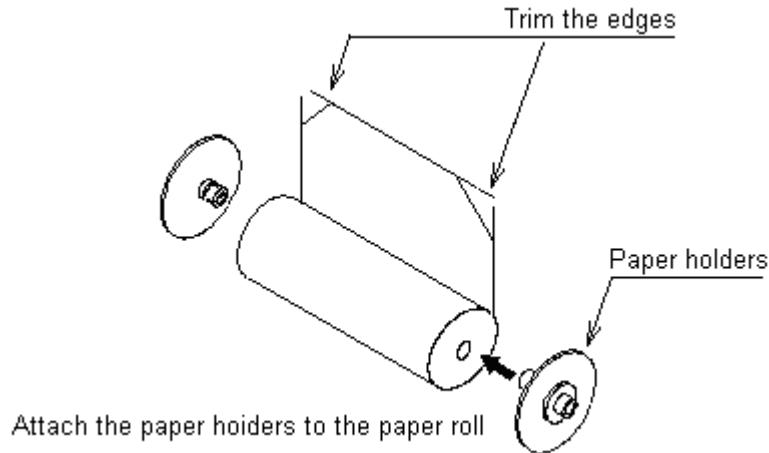

NOTE

Use only the paper roll prepared exclusively for this recorder by our company (YPS106 and YPS108 and YPS114). If other types are used, the recording quality cannot be guaranteed, and the normal operation of the paper feed may be affected.

Do not use the portion of the new roll that is covered with tape, as colors may not be printed normally on this area.

(2) Pull the levers at the both sides of the front door and open the printing block.

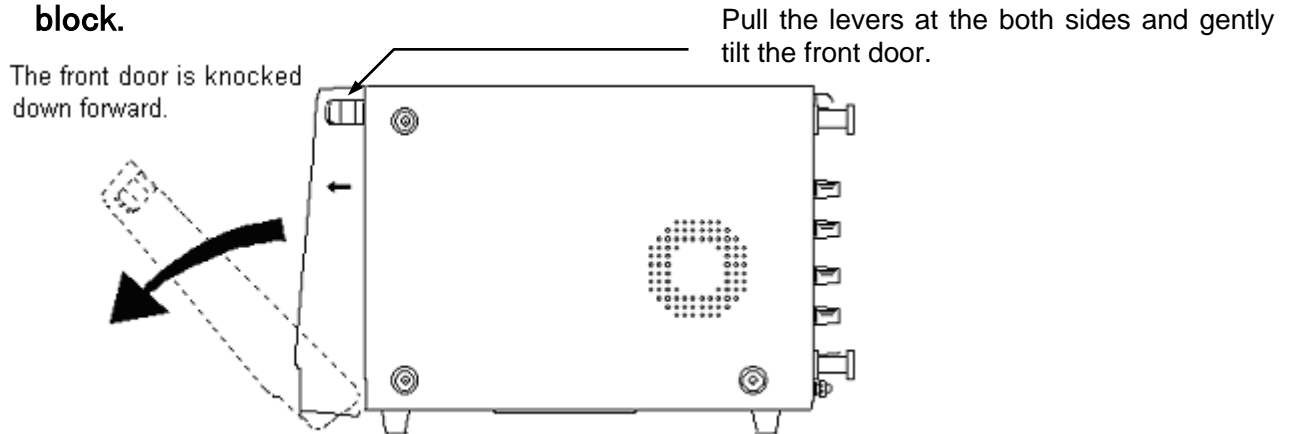

NOTE

Do not place any object on the front door that is tilted. If the thermal head is damaged, correct printing cannot be made.

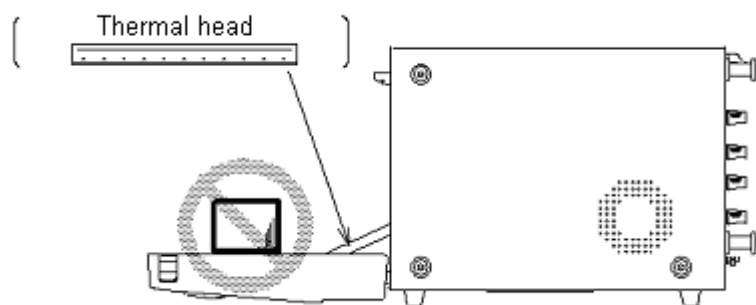

(3) Loading the recording paper in the stock section in the RA2800A with the paper guide axis

Load the recording paper with paper holders in the stock section in the RA2800A mainframe and push them until they click into place.

NOTE

Check the recording paper so that the thermal sensitive face is to be the front face. If the recording paper is loaded inversely, printing cannot be made.

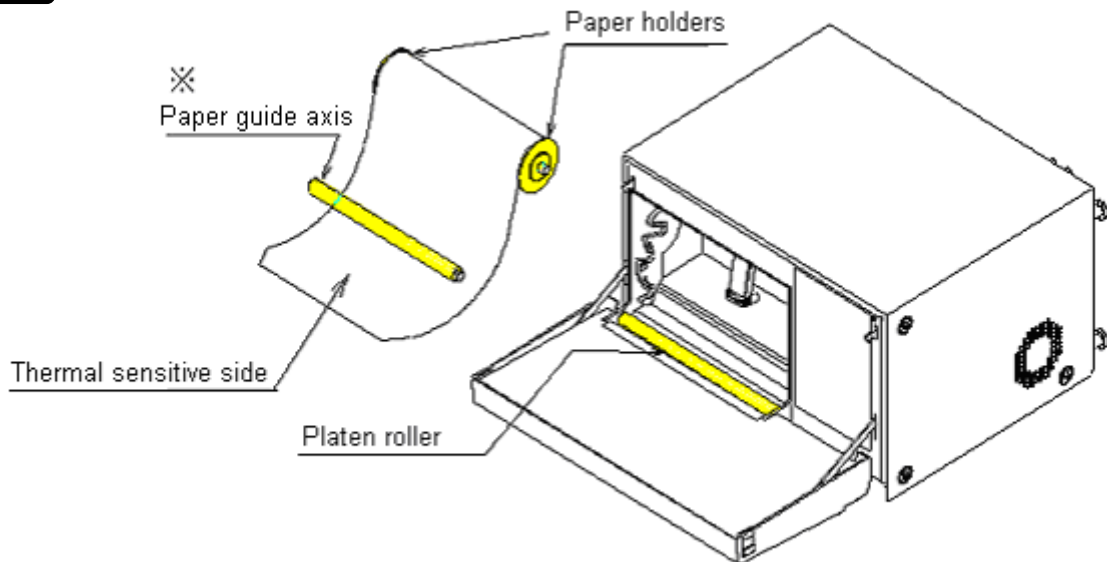

NOTE

Push the printing paper holders into the paper holder in the mainframe (1) on the drawing on the right) until a click is heard.

The paper guide axis is included in this paper holder when the unit is shipped.

Take out the axis to install the printing paper holder, and after installing, fix the axis.

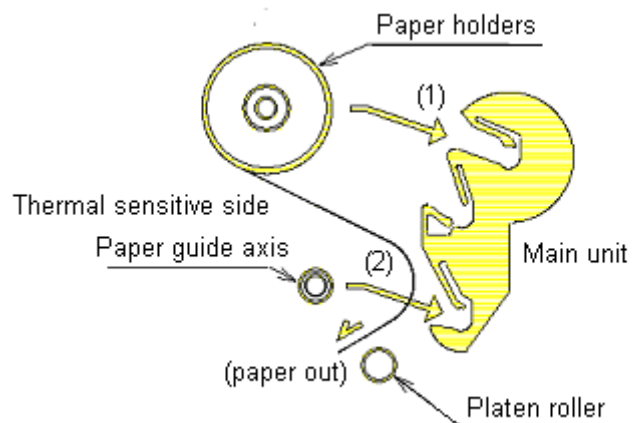

(4) Pull out the paper

Put in the end of printing paper above the platen roller and pull the paper about 10 cm. Check the printing paper coming out of the paper feed exit.

Pull the paper straight and tight. Correct paper feed cannot be made if the paper is not pulled straight.

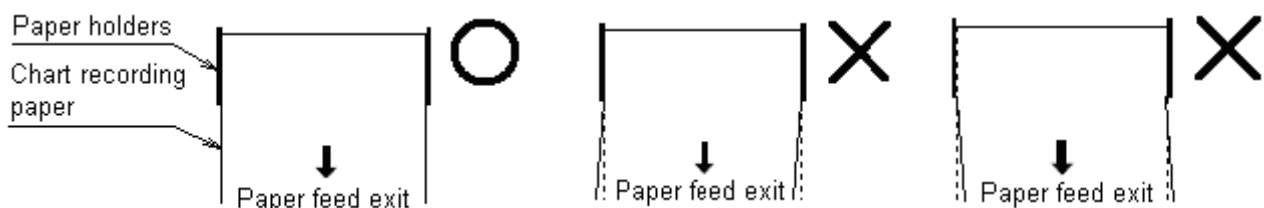

(5) Close the cover

After pulling the printing paper, close the cover holding the both sides with hands until the cover click into place. Pull the printing paper straight. Confirm the both sides of the upper part of the cover are closed. Otherwise correct printing cannot be made.

3.2.2. Loading z-fold paper

To use z-fold paper (YPS112), a z-fold paper case (RA28-115, sold separately) is required.

《Z-fold paper》

YPS112

- Length: 200 m
- Folded width: 30 cm
- To indicate how much paper is remaining, a page number (669 to 000) is printed on each page.

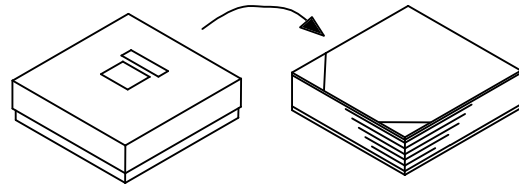

NOTE

Use only the z-fold paper prepared exclusively for this recorder by our company. If other types are used, the recording quality cannot be guaranteed, and the normal operation of the paper feed may be affected.

《Z-fold paper case》

- Z-fold paper case: RA28-115
- Z-fold paper case: About 3 kg
- A z-fold stock box (about 300 g) comes with the z-fold paper case
- A z-fold paper case adaptor: About 200 g

《External dimensions of z-fold paper case》

See the drawing in 18.15. 6.

(1) Placing RA2800A on the Z-fold paper case

Place the Z-fold paper case on a flat place. Then place this recorder on top of the case, aligning the rubber legs with the hollows of the case.

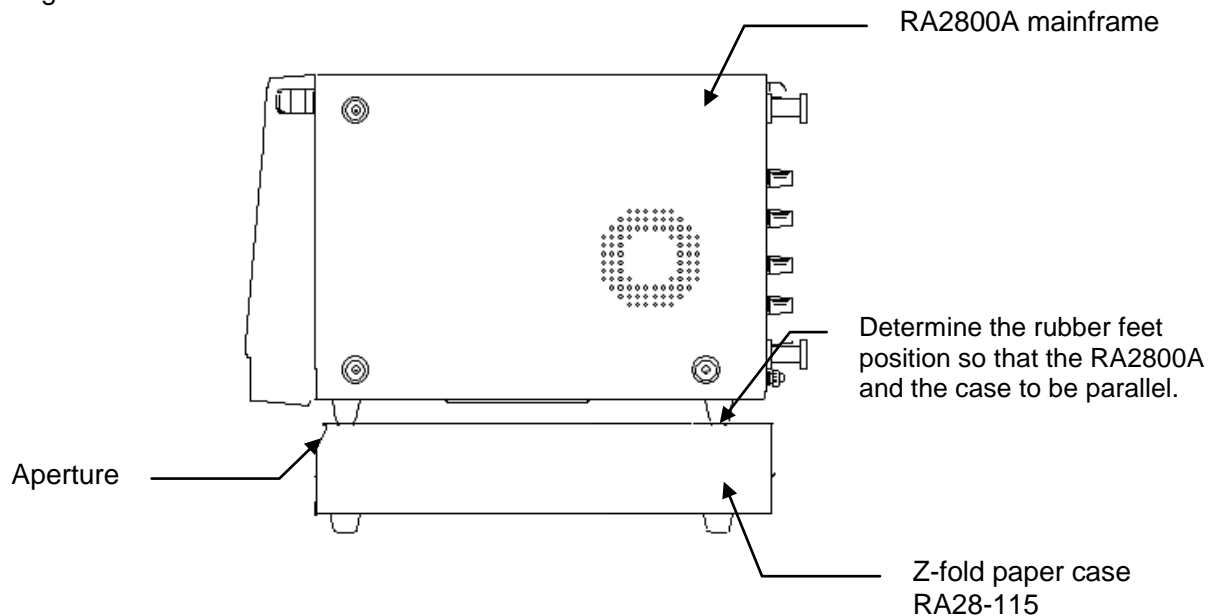

(2) Put the paper in the case

- (1) Remove the contents from the case, open the plastic bag and take out the piece of cardboard covering the paper. Use the top cover of the case as a receptacle for the recorded paper.

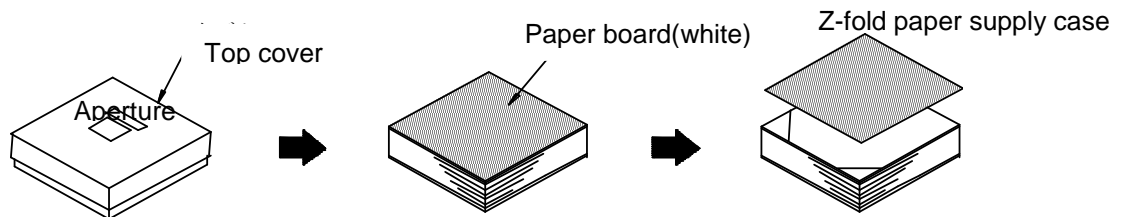

- (2) Place the paper in the stock box with the thermally sensitive side (the side with blue numbers printed on the edges) facing up.

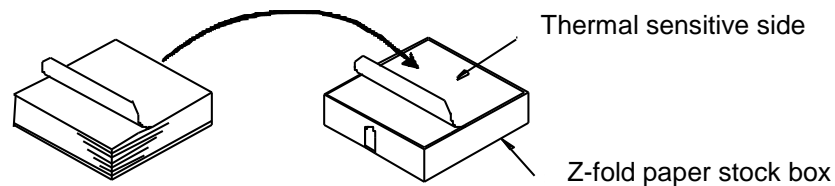

- (3) Position the stock box so the paper flap edge (non-folded edge) is facing toward you and insert the box into the case opening.

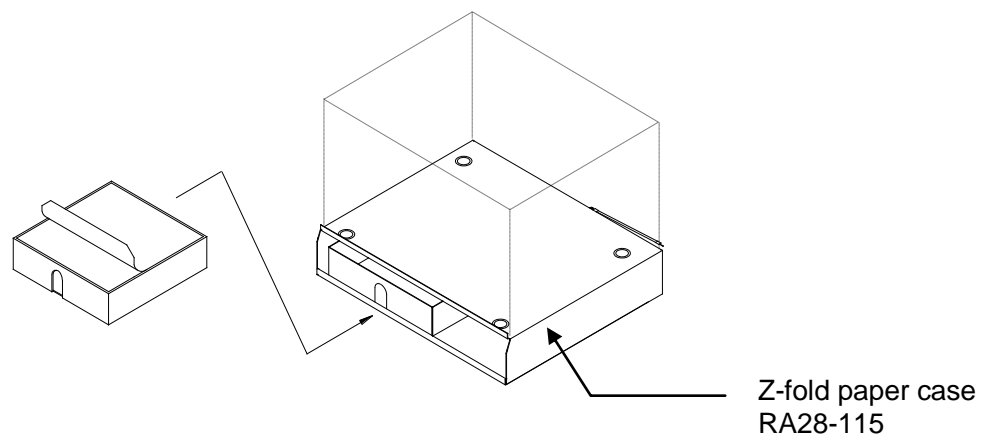

(3) Attaching the Z-fold paper adapter

Pull the lever on both sides of the front door and gently tilt the door. Push the Z-fold paper adapter and paper guide axis into the recording paper loading section in the RA2800A unit until they click into place.

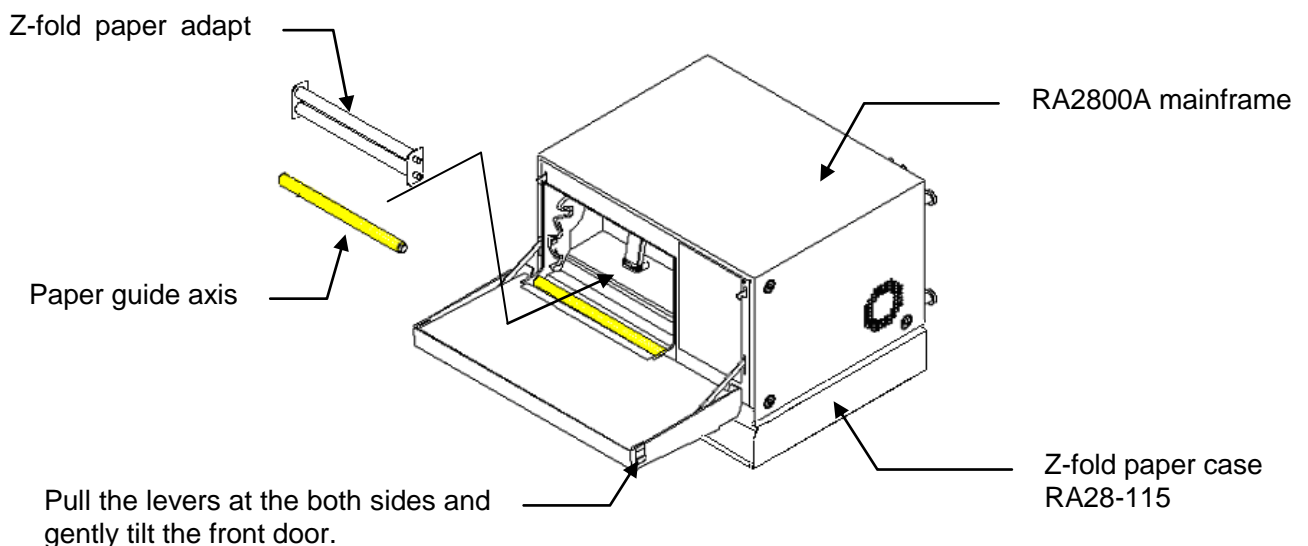

(4) Thread the paper through the z-fold paper adapter

Wind the recording paper from the Z-fold paper case around the Z-fold paper adapter as below.

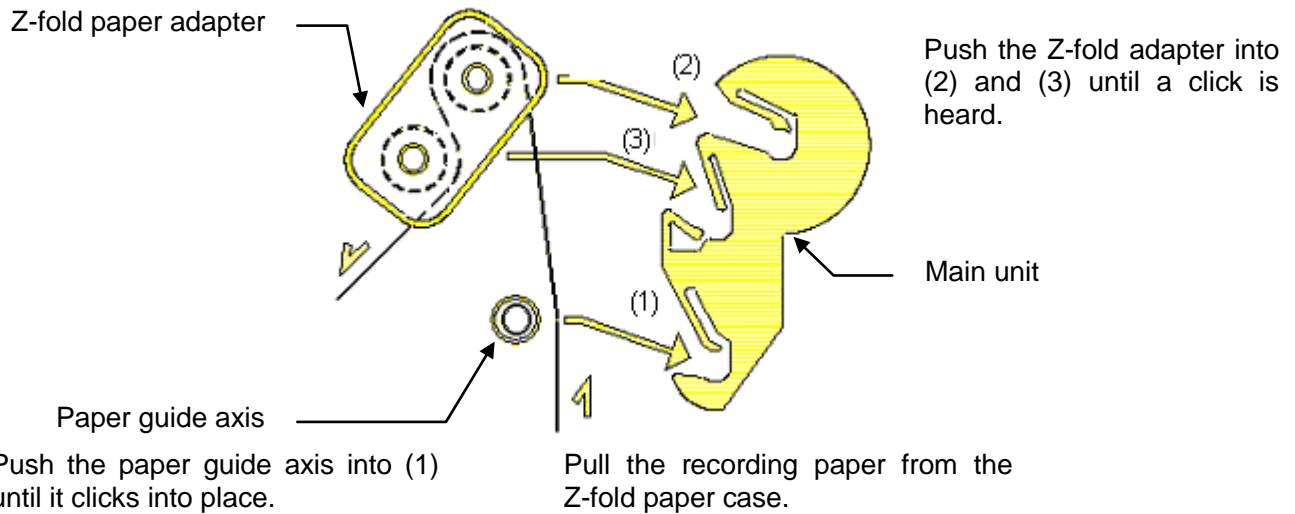

(5) Insert the paper adapter in the slots of the cover

Press the paper adapter with the paper wound on it into the slots until a click is heard. Insert the paper wound on the adapter in the opening under the platen roller (black roller) of the recording section and pull it out about 10 cm from under.

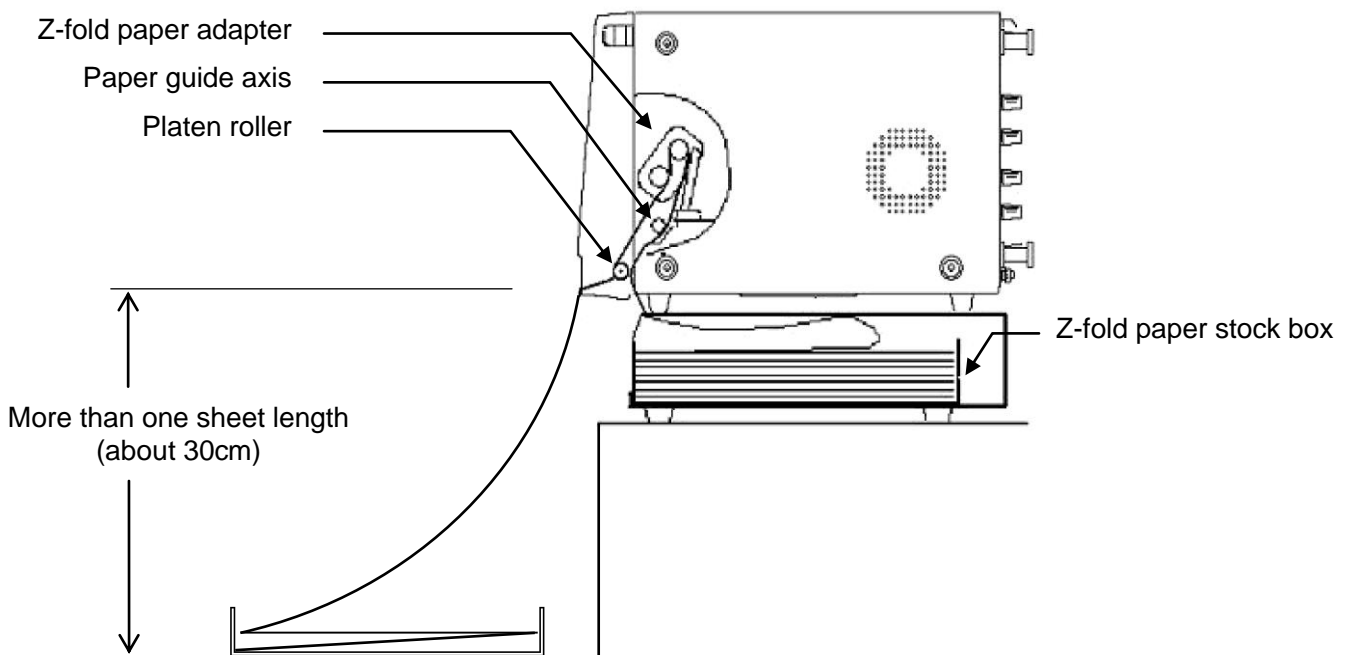

(6) Close the cover

After pulling out the paper, making sure it is straight, close firmly pressing with both hands on the both sides of the cover.

TIPS

Place the cover of the box containing the paper in front of the recording section cover to use as a paper receptacle. In order to keep stable paper output, please set the height of the unit more than one sheet length (about 30cm), so that paper may automatically be pulled out by own weight. To ensure smooth paper output, fold one or two sheets into the receptacle before use.

Note that although z-fold paper usually folds automatically as it is output, some environmental conditions, such as a humid atmosphere or the setting location, may cause the paper not to fold normally.

3.3. Insert the Amp Unit



CAUTION

◆ Caution in handling

When replacing an amp unit, disconnect the power cable and the signal input cable from the recorder after turning off the power. Replacement of the unit while the power switch is on causes a damage of the unit and the recorder.

During the replacement, avoid touching the internal parts. If a user having static electricity touches internal parts, the parts may be damaged. As touching the parts may cause a failure, never touch the parts other than panels during the replacement.

- (1) Turn off the power
- (2) Remove the power cable.
- (3) Remove input cables connected each amp unit.
- (4) Check if the power switch is off.

Tighten each amp-fixed screw on the upper and the lower using a screwdriver to fix the unit.

(Screwdriver: edge width, 0.65 mm or less) Loosen the screws until removing the connection of this recorder. (Take care over-loosening of the screw not to remove the unit.)

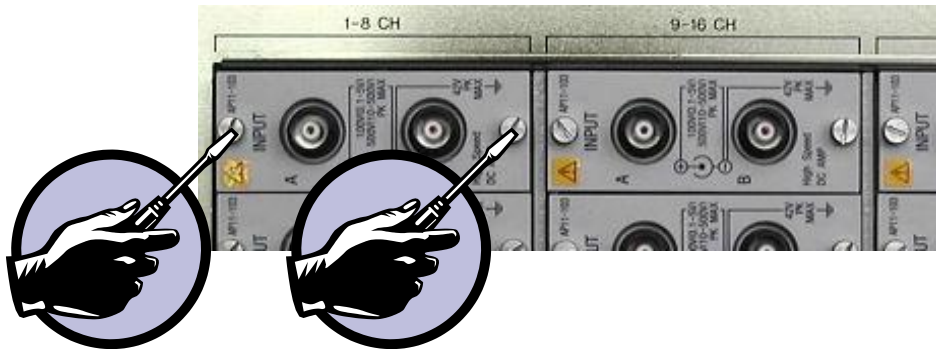

- (5) Pull out the amp unit by pulling two screws at the upper and lower part of the unit. By doing so, you can remove the unit smoothly. To insert a unit, perform the reverse procedure. Tighten screws firmly using a screwdriver. Perform this procedure while the power is off.



CAUTION

To prevent an electric shock and damage due to an entry of obstacles, always attach a blank panel for the slot without amp unit.

3.4. Turning on the Power

◆ When all the preparations are complete, turn on the recorder.

<Points to be checked before applying power>

- Has this recorder been set on a safe place?
- Has this recorder been set under a proper environment?
- Is the power switch currently off?
- Is this recorder grounded?

After confirming that these points above are all yes, turn on the recorder following to the steps below.

(1) Connect the inlet side of the AC power cable to the AC socket of this recorder

Connect the inlet side of the accessory AC power cable to the AC socket on the power supply panel of this recorder.

(2) Connect the plug of the AC power cable to the power outlet

(3) Turn on the recorder power

Turn on the POWER switch on the lower left of the RA2800A mainframe.

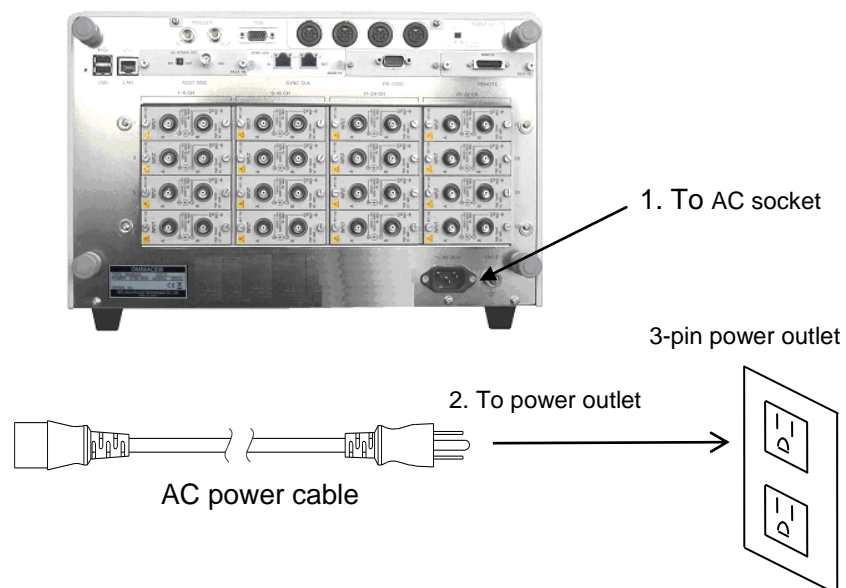

◆ After power application

After applying power, check the following.

(1) Confirm that the image is properly displayed on the screen

The [Input Monitor] screen will be displayed immediately after power application.



(2) Confirm that the paper is fed correctly

This can be confirmed by pressing the [Feed] key on the operation panel. If no paper is fed, check whether the cover is closed properly or not.

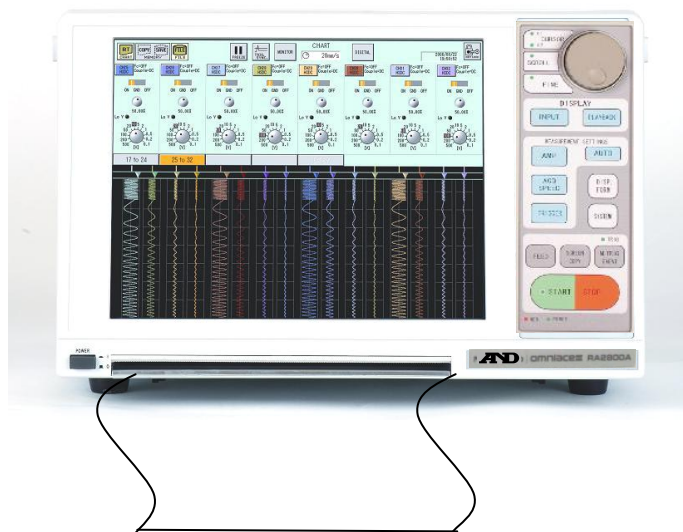

Press

(3) The pre-measurement procedures are completed.

***4. Operation Flow
Flow of Measurement,
Basic Settings and
Operations***

4.1. Operation Flow

This recorder records, stores, and replays input signals, following the procedures described below.

(1) Before power application

Confirm that this recorder has been set in a safe place, and that all the accessories are properly attached.

 Refer to Chapter 3 for details.

(2) Applying power

● Inputting signals to the amp units.

Note that applying a voltage greater than the maximum allowable input voltage specified by the sensitivity setting of each amplifier unit may cause damage to the main unit or internal components.

 Refer to AMP Unit Instruction Manual for details.

● Confirming the status of the signals

Input signals can be monitored in real-time.

 Refer to Chapter 5 for details.

(3) Settings

● Amplifier unit settings

Set the conditions for the data to be recorded.

 Refer to Chapter 7 for details.

● Trigger settings

Set the trigger for activating to be recorded.

 Refer to Chapter 13 for details.

● Measurement mode settings

Select the mode appropriate for the kind of object desired from the 5 available measurement modes.

• To print the recording chart paper

 Refer to Chapter 8 for details.

Pen recorder mode

• To store high-speed events in memory

 Refer to Chapter 9 for details.

Memory recorder mode

• To store and record events over a long time in HDD

 Refer to Chapter 10 for details.

HD recorder mode

• To store events quickly during low-speed signal recording

 Refer to Chapter 11 for details.

Multi-recorder mode

• To use as X-Y recorder

 Refer to Chapter 12 for details.

X-Y recorder mode

(4) Measurement

Start measurement with the [START] key on the operation panel.

Stop measurement with the [STOP] key on the operation panel.

(5) Replay

Display stored data

 Refer to Chapter 14 for details.

Replay settings

Copy stored data on the recording paper or save a file of the data

 Refer to Chapter 14 for details.

Output selection

4.2. Making Basic Settings

This section explains various setting items and icons on the screen. As the display is of a touch panel, settings can be made by directly touching the keys on the display screen.

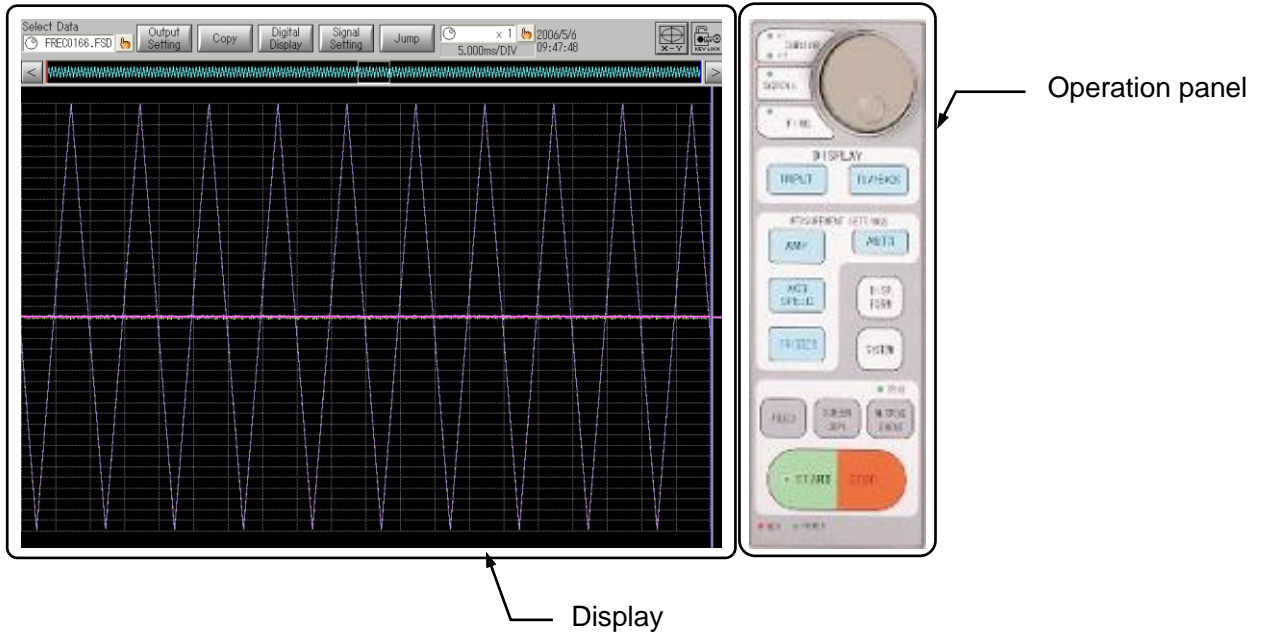

4.2.1. Explanation of Basic Screen Settings

The setting screen is broadly divided into the control, waveform monitoring, and setting blocks.

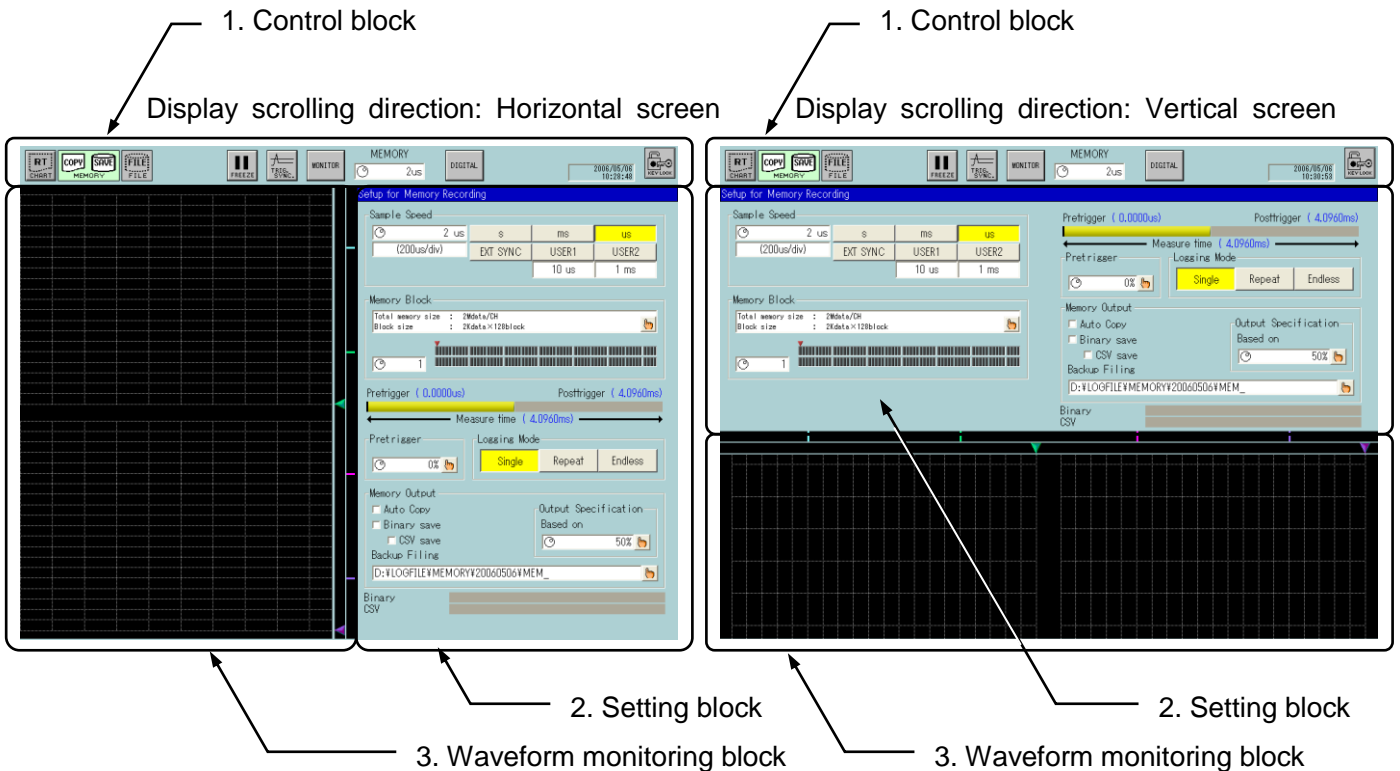

(1) Control block

This block is always displayed on the top of the screen and is used for setting function and switching the screen. The contents of the control block change in accordance with a measurement mode and a setting item being selected. Refer to various measurement modes of Chapters 8-12 for details about control block.

(2) Setting block

To display a setting screen on this block, press the [Amp], [Store condition], and [Trigger] button on the operation panel. Refer to description of various measurement modes of [Chapter 8 Amp Unit], [Chapter 13 Trigger Settings], and [Chapters 8-12] for details about operation on a setting screen.

(3) Waveform monitor block

Because the input waveform monitor is always displayed on the normal setting screen, settings can be made while observing the input signals.

4.2.2. Explanation of setting keys

Each setting item displays a different image depending on the input method to be used. The various input methods are explained below.

- **Jog key**

When the jog dial image is displayed in the setting block, the jog dial on the operation panel can make settings. Use the jog dial to change the setting value of the item that is highlighted (active).

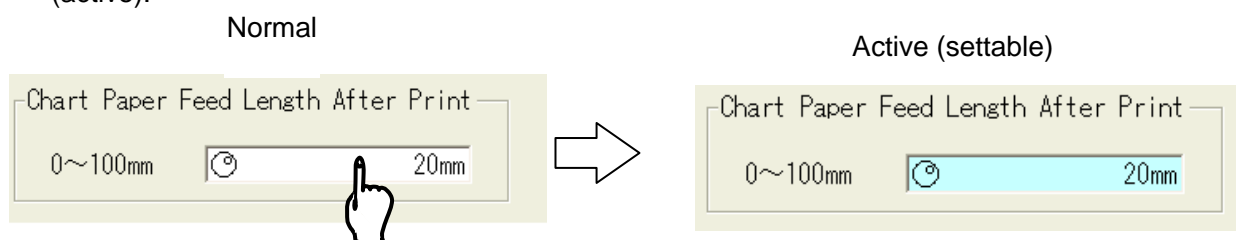

- **Window key**

“Hand” icon displayed on the key indicates that a window will open upon selection. Settings can be made in this newly opened window.



- **Jog key + “HAND” icon**

In this case, the operation is a combination of the above two items. When the blank of the setting block is selected, the key operates as the jog dial (item highlighted), and when the icon is selected, a setting window will open.



- **Check boxes**

When a check box is pressed, a check will alternatively appear and disappear.

Several selections are available.

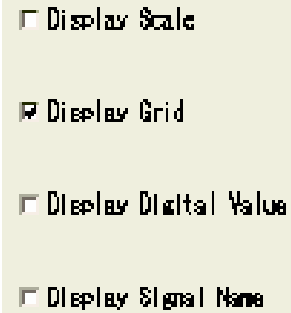

- **Radio button**

When a radio button is pressed, a check will alternatively appear and disappear. Select only one among two or more items. (Setting by which two or more selections are prohibited)

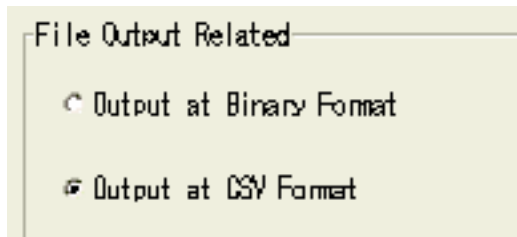

- **Rotary knob**

Rotary knob is a knob-type key used for the range setting for input amplifiers. Value changes by rotating the jog dial after the color of the key changes by touching the key (entry state of the jog dial). The highlighted value is the current value to be set.



- **Adjustment knob**

This knob is used to change the base line position for an input amplifier. Value changes by rotating the jog dial after the color of the key changes by touching the key (entry state of the jog dial). The set value is displayed under the key.

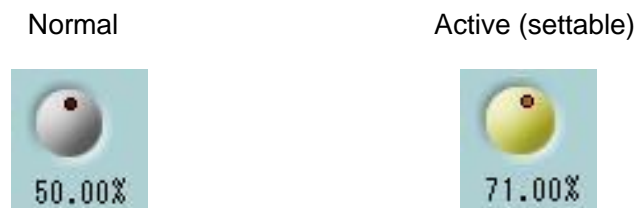

4.2.3. Explanation of standard setting windows

This recorder uses common setting windows to set values that are commonly used.

● **Numerical input window**

Use this window to enter numerical values.

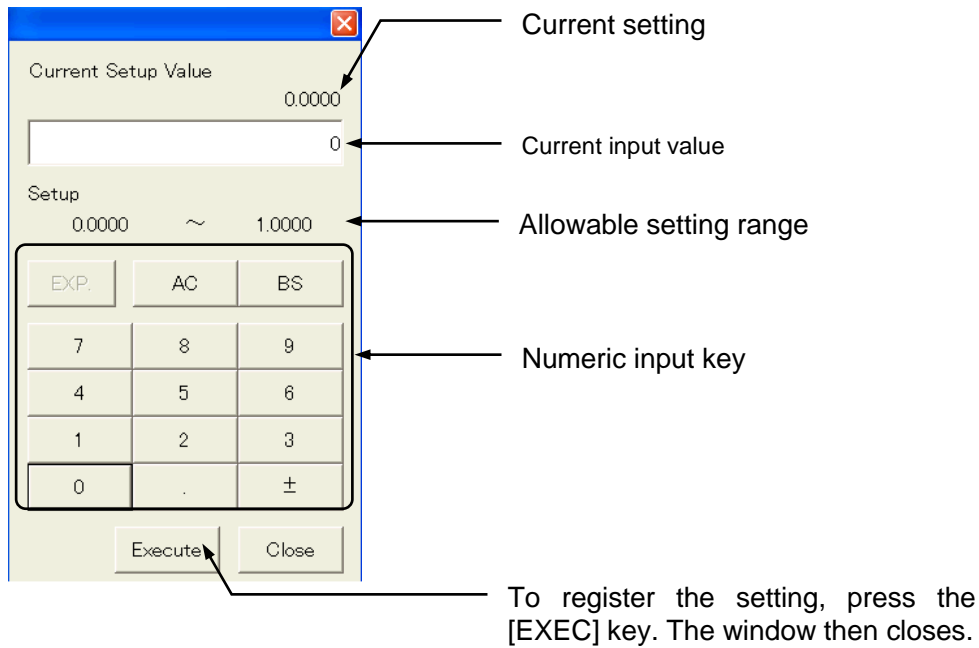

● **Character input window**

Use this window to input character strings.

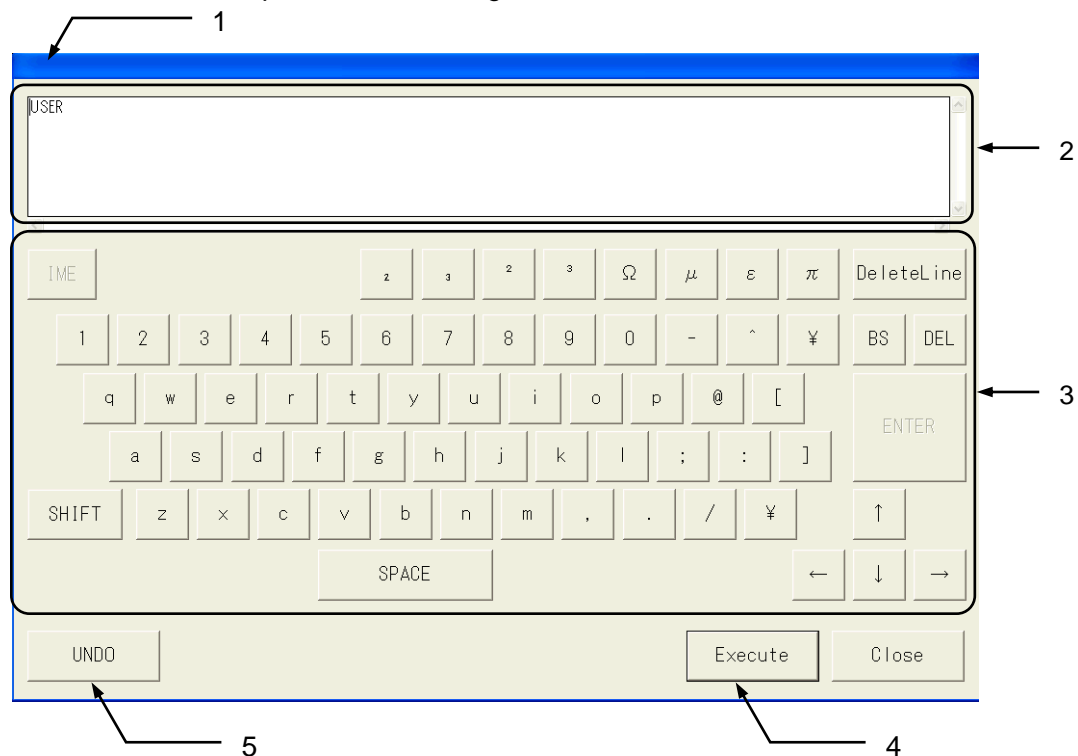

1: Window title

This displays contents of the setting item.

2: Input display section

This section displays input character strings and cursor position.

3: Input operation section

This section operates input character strings from various keys.

[Delete line]

Erases only the line indicated by the cursor

Capital letters and symbols can be input by pressing the [SHIFT] key

When the key is pressed, images displayed on the keyboard are changed after the key is highlighted, thereby capital letters and symbols can be input.

Character strings to convert into kanji can be input by pressing the [IME] key.

When the key is pressed, kana input mode using Roman character is changed after the key is highlighted.

To convert kana into kanji, press the [Blank/Conversion] key.

To select among kanji list, press the [Arrow] key or [Blank/Conversion] key. (To select among kanji list on the panel, touch the panel directly.)

To confirm the selection, press the [Return] key.

Avoid inputting special characters (the upper key on input operation section such as Ω , μ , ε) during IME mode.

4. [EXEC] key

To register character strings to input, press this key. The window will then close.

5: [Undo] key

To restore the previous entry, press this key.

5. Input Signal Monitor Observing Input Signals

5.1. Observing Input Signals

To observe the signals that are input, use the Input Signal screen. This screen displays the signals that are input in real time. The waveforms can be frozen as necessary.

Display scrolling direction: Horizontal screen

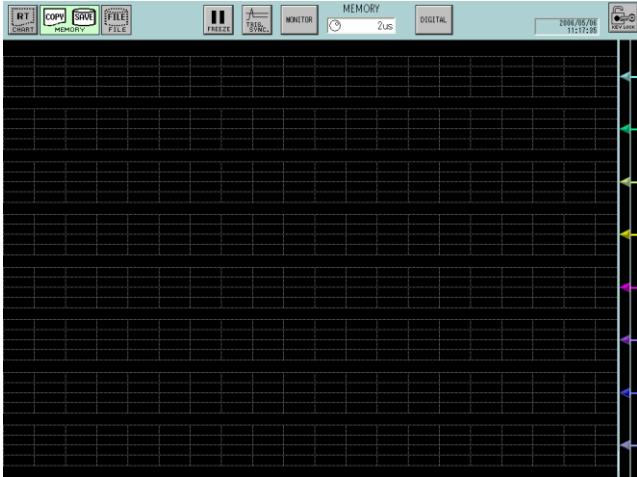

Display scrolling direction: Vertical screen



TIPS

When measuring mode is set as X-Y recorder, the display is set as below.

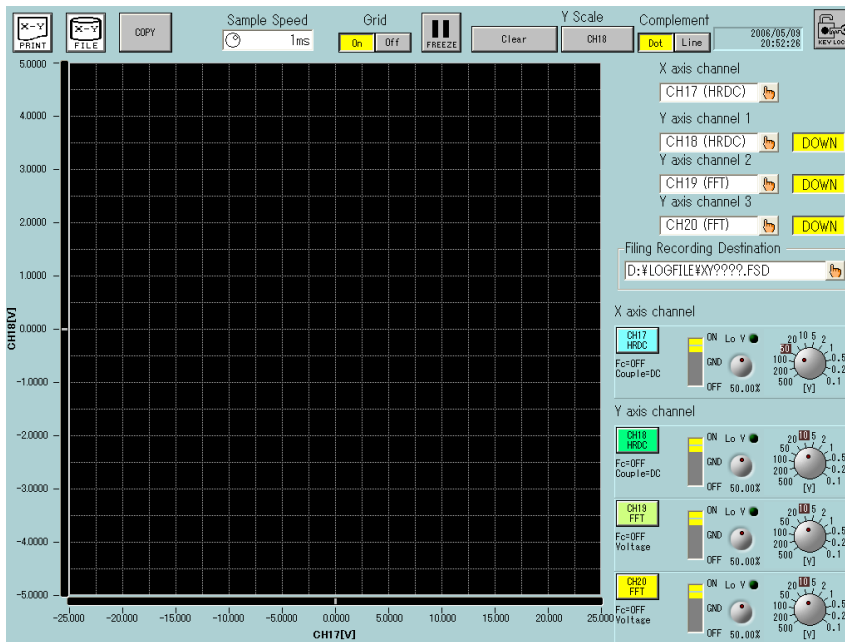

* Display scrolling directions are invalid in this screen

5.2. Displaying Input Waveform Monitor

The screen below is a screen appears when the Input Signal button is pressed in the Memory Recorder Mode.

Display scrolling direction: Horizontal screen

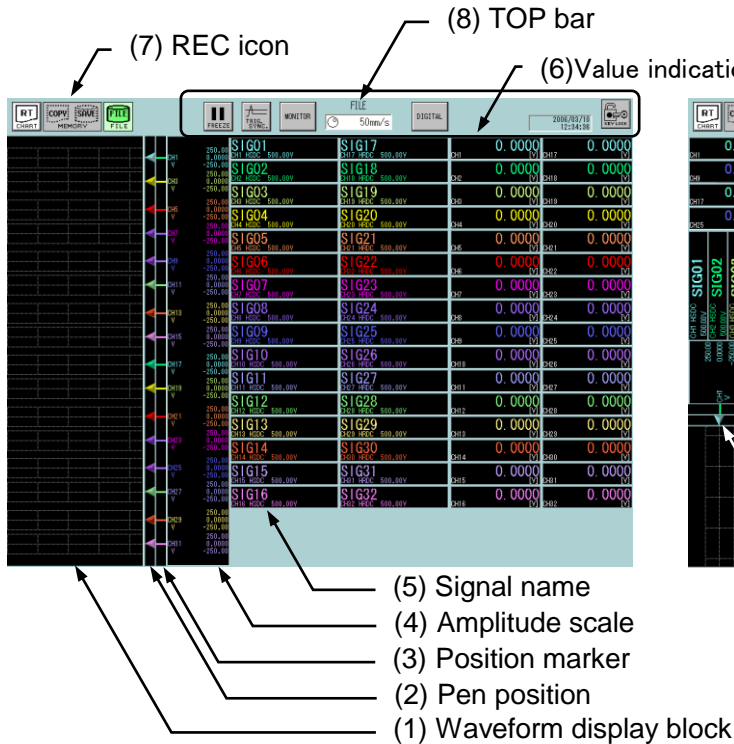

Display scrolling direction: Vertical screen

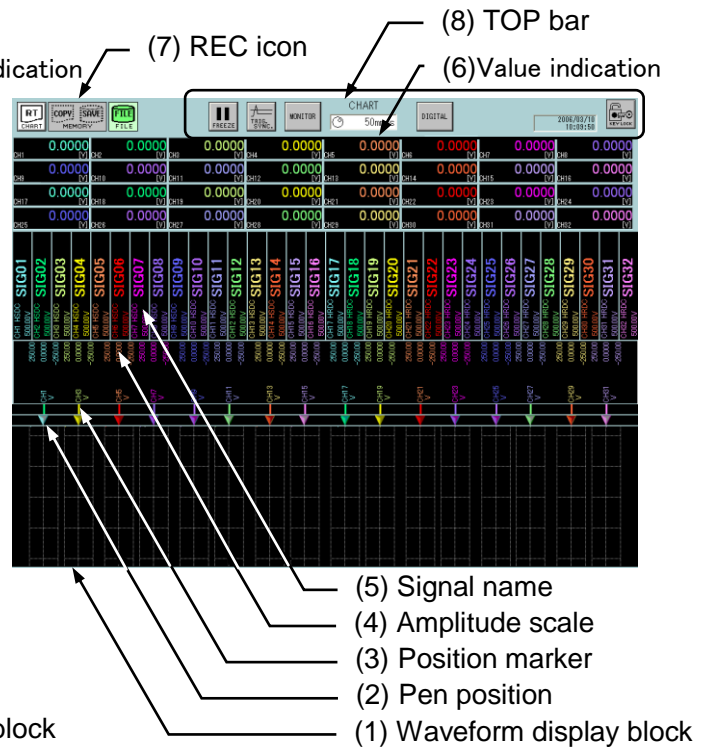

(1) Waveform display block

Waveform display format can be set. With this setting, waveform segmentation for display and printing can be made.

Chapter 15 Display and Printing

(2) Pen position

Current values for analog amps are indicated with the pen position.

(3) Position marker

This is zero position for all analog amps.

(4) Amplitude scale

This is amplitude scale for analog amps. This scale can be hidden depending on the setup.

Chapter 15 Display and Printing

(5) Signal name

Indication of signal name that are entered by user can be made. The signal name can be hidden depending on the setup.

Chapter 15 Display and Printing

Chapter 16 System Setup

(6) Value indication

Numerical values of currently input signals are indicated. The values can be hidden depending on the setup.

Chapter 16 System Setup

(7) REC icon

Status of printing and recording is shown. The contents differ depending on the measurement mode. For more information, see descriptions of measurement modes in Chapters 8 to 12.

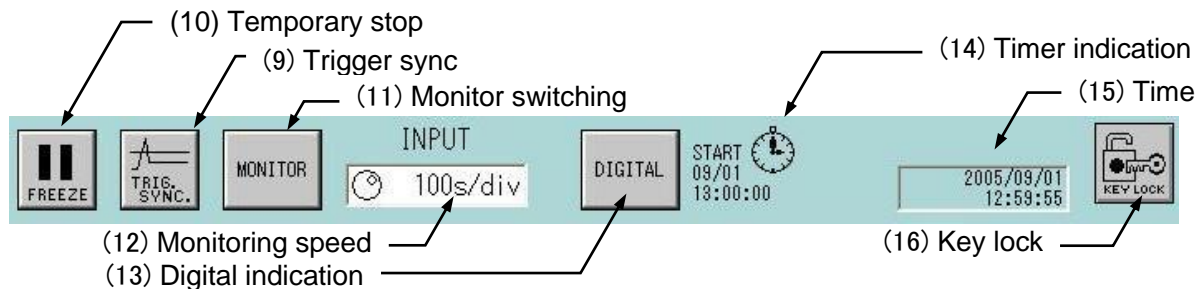
(8) TOP bar**(9) Trigger sync**

This button sets whether updating for input waveform monitoring is made through the trigger detection or not. To monitor high-speed and periodic signals, this function is effective.

(10) Temporary stop

This button halts monitoring. Pressing the button again resumes monitoring.

(11) Monitor switching

This button switches input waveform monitoring mode. The monitor mode changes with button. The mode for monitoring varies depending on the measurement mode. See the table below.

Monitor mode	Description	Recorder mode		
		Memory	HD	Multi
Input Monitor	Fixed-speed for input monitor	Enabled	Enabled	Enabled
Chart Feed Speed	Monitor displaying same speed as the chart feed speed.	Disabled	Enabled	Enabled
Memory Sampling Speed	Monitor displaying same speed as the memory sampling speed	Enabled	Disabled	Enabled
HD Recording Speed	Monitor display same speed as the HD recording speed	Disabled	Enabled	Enabled

※Monitor speed setting becomes disabled when settings other than the Input Monitor mode is set.

※This button does not appear in the Pen Recorder and X-Y Recorder modes.

※A left edge of the monitor screen is a starting point of trigger in the memory recorder mode.

(12) Monitoring speed

When the monitor mode is set to Input Monitor, monitoring speed can be selected. Use the jog dial or the window to set.

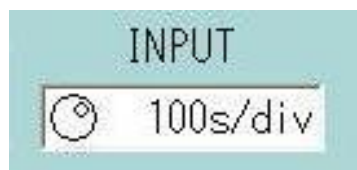

If the monitoring mode is set to other than the Input Monitor, the monitoring speed indicates a fixed-recording speed. If the setting is changed, the fixed speed is changed.

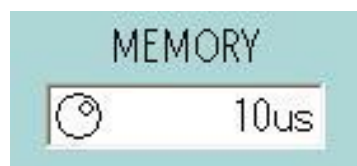

(13) Digital indication

Input signal values are indicated in the form of digital value. Pressing this button switches between No and Digital Value.

(14) Timer indication

If the timer printing is set, the recording time for the next session. If it is not set, nothing is indicated.

 16 System Settings

(15) Time

This portion indicates the current time.

(16) Key lock

By setting this function, key entries on the operation panel are blocked. Pressing this button switches key lock on and off.



Key lock OFF



Key lock ON

 16 System Settings

6. Auto Setup Automatically Setting Recording Conditions

6.1. Function Overview

The auto setup function automatically sets recording conditions by referencing the signals currently input. The following parameters are automatically set.

- Auto range (for analog amps only)
- Auto sample

To execute this function, press the Auto button.

TIPS

While recording is made, the auto setup function is not available. The time needed to validate the auto setup varies depending on the signals that are input. As the auto setup function sets recording conditions roughly, set conditions manually if precise setup is required.

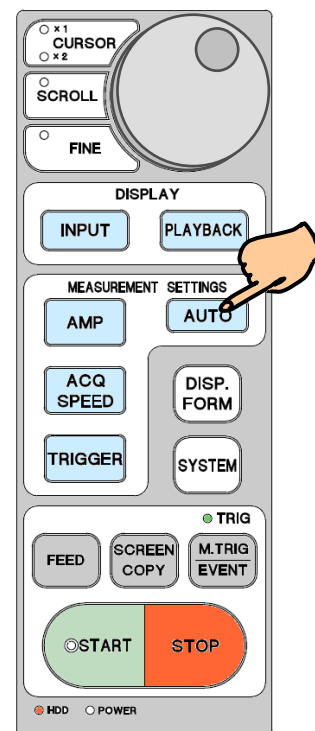

6.2. Auto Range

This function automatically sets the range of analog amps. The auto range function is available in the following amps.

Unit Name	Model	Abbreviation
2CH High-Resolution DC Amp Unit	AP11-101	HRDC
2CH FFT Amp Unit	AP11-102	HSDC
2CH High-Speed DC Amp Unit	AP11-103	FFT
2CH AC Strain Amp Unit	AP11-104A	ACST
Event Amp Unit	AP11-105	EV
2CH TC/DC Amp Unit	AP11-106A	TCDC
TC/DC Amp Unit	AP11-107	TDC
F/V Converter Unit	AP11-108	FV
2CH Vibration and RMS Amp Unit	AP11-109	RMS
2CH DC Strain Amp Unit	AP11-110	DCST
2CH Zero Suppression Amp Unit	AP11-111	HRZS

The auto range is executed from an amp screen detailed windows.

See  Chapter 7 Amp Unit

TIPS

If there is no signals, the reference measurement value will be the zero level, the adjusted value will be the highest sensitivity. If the high-sensitivity disabled setting in a DC amp is effective, the range is adjusted within the low-sensitivity range.

6.3. Auto Sampling

The auto sampling function sets the monitor displaying speed, chart paper feed speed, memory sampling rate, and file recording rate based on the signals currently input.

6.3.1. Target Setup Conditions

The relation between settable conditions and mode are as follows. The monitor displaying speed is always settable.

	Measurement Mode				
	Pen Recorder	Memory	HD	Multi	X-Y
Monitor displaying speed	Available	Available	Available	Available	-
Chart feed speed	Available	-	-	-	-
Memory sampling rate	-	Available	-	Available	-
File recording rate	-	-	Available	-	-
X-Y sampling rate	-	-	-	-	-

Available: Adjusted, -: Not adjusted

TIPS

In the X-Y Recorder mode, the auto sampling does not function. (For X-Y data sampling rate, make adjustment with seeing the monitor.)

6.3.2. Adjustment Range

Chart feed speed	Memory sampling speed	File recording speed
50 mm/s (2 ms)	2 μ s	20 μ s
20 mm/s (5 ms)	5 μ s	100 μ s
10 mm/s (10 ms)	10 μ s	200 μ s
5 mm/s (20 ms)	20 μ s	500 μ s
1 mm/s (100 ms)	50 μ s	1 ms
100 mm/min (60 ms)	100 μ s	2 ms
50 mm/min (120 ms)	200 μ s	5 ms
20 mm/min (300 ms)	500 μ s	10 ms
10 mm/min (600 ms)	1 ms	20 ms
5 mm/min (1.2 s)	2 ms	50 ms
1 mm/min (6 s)	5 ms	100 ms

- The values in parentheses in chart feed speed corresponds to the data sampling speed.
- The file acquisition speeds above are speeds while all 32 channel are used

7. Amp Units

7.1. Settings for Input Units

This section covers how to make settings on the Amp Basics and Amp Details screens. For detailed settings for amps, (RA2000 Series Amp Units User's Manual – Integrated Version)
 To set range and waveform printing for input unit, the Amp screen is used. The following screen appears after pressing the Amp button.

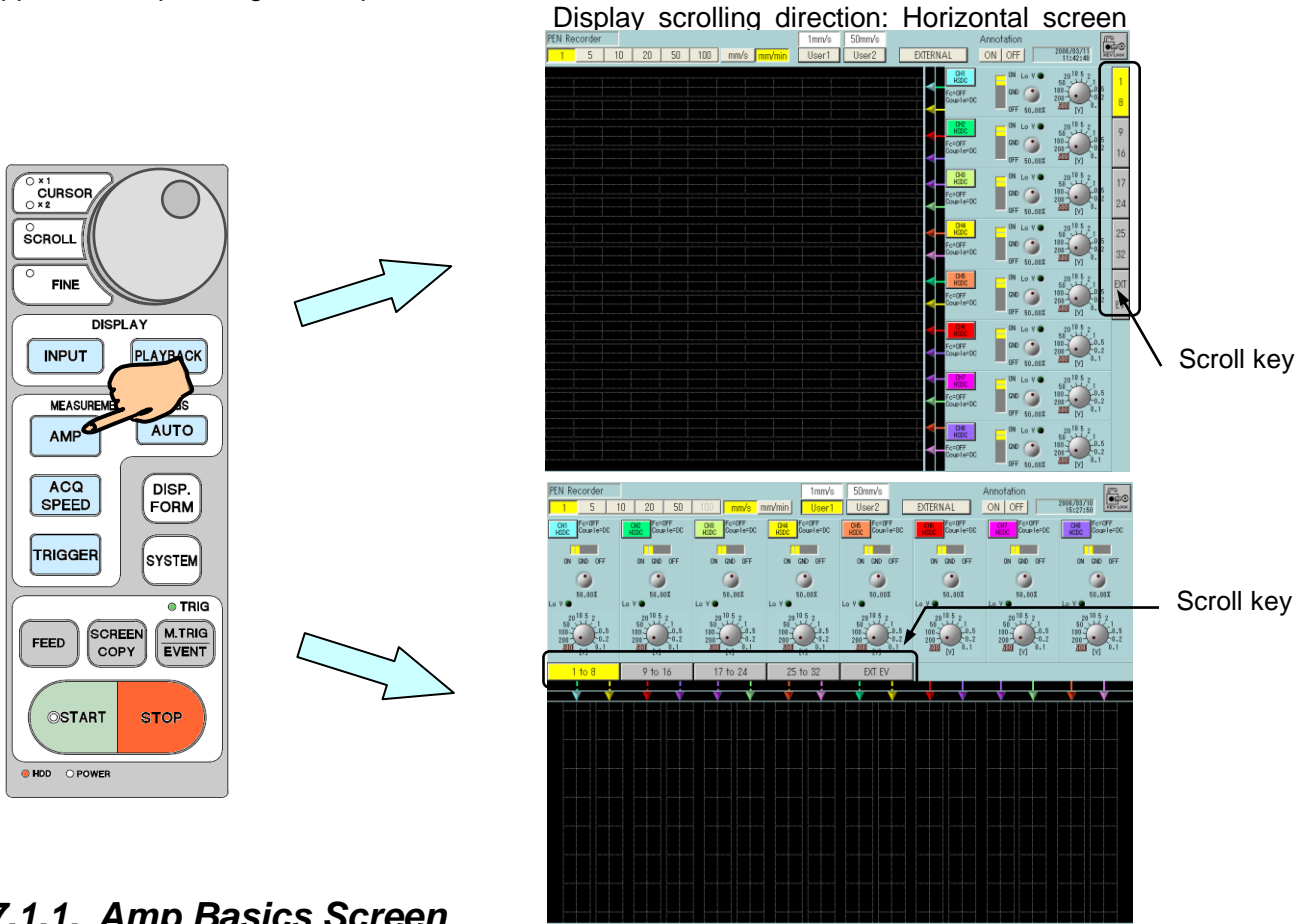

7.1.1. Amp Basics Screen

In the Amp Basics screen, input unit setup condition can be checked by channel. To change the channel, use the Scroll button.

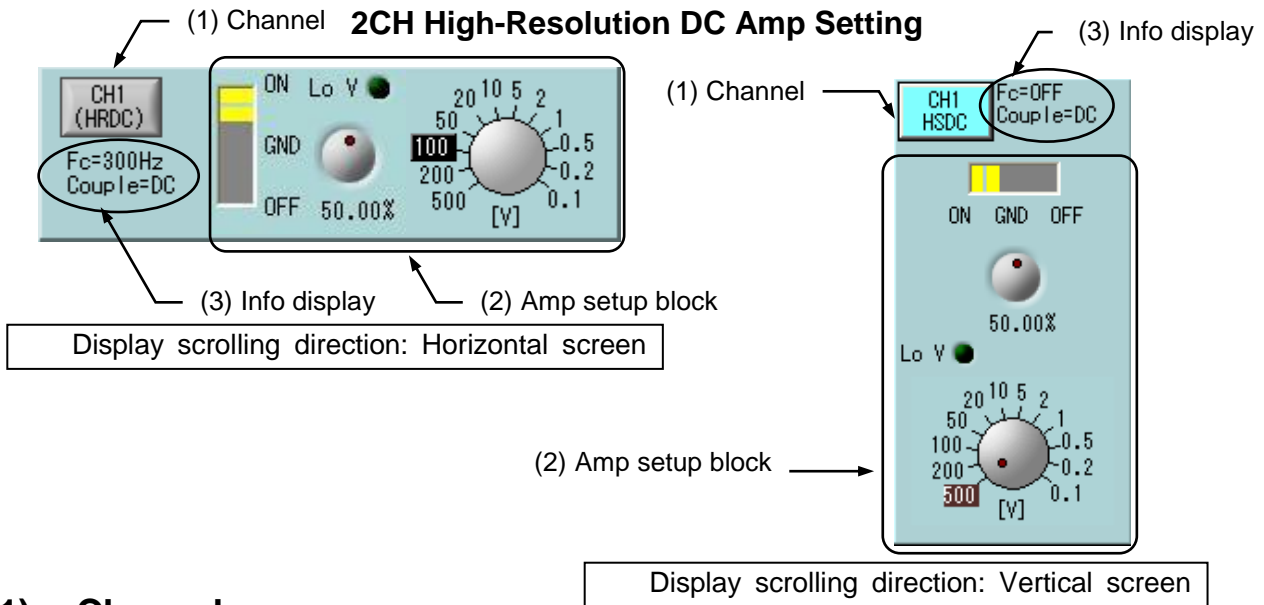

(1) Channel

Channel number, amp type, and waveform color are indicated on this button. Pressing this button displays the Amp Details screen, making more detailed setup.

(2) Amp setup block

This block is used to set basic settings for amp. As contents differ depending on the amp type, refer to the descriptions of each amp.

NOTE

Even if the case using FFT Amp (AP11-102) or frequency RMS Amp (AP11-109) to setup a sensor's sensitivity m/s^2 or G, the Amplifier display automatically shows voltages in high sensitivity setting.

(3) Information display

Setup information that is not indicated in the Amp Basic screen is displayed. The detailed settings are made in the Amp Details screen. As contents differ depending on the amp type, refer to the descriptions of each amp.

7.1.2. Amp Details Screen

The Amp Details screen appears when the Channel button is pressed on the Amp Basic screen. Detailed channel settings can be made. The following screen is a screen for 2CH High-Resolution DC Amp (AP11-101).

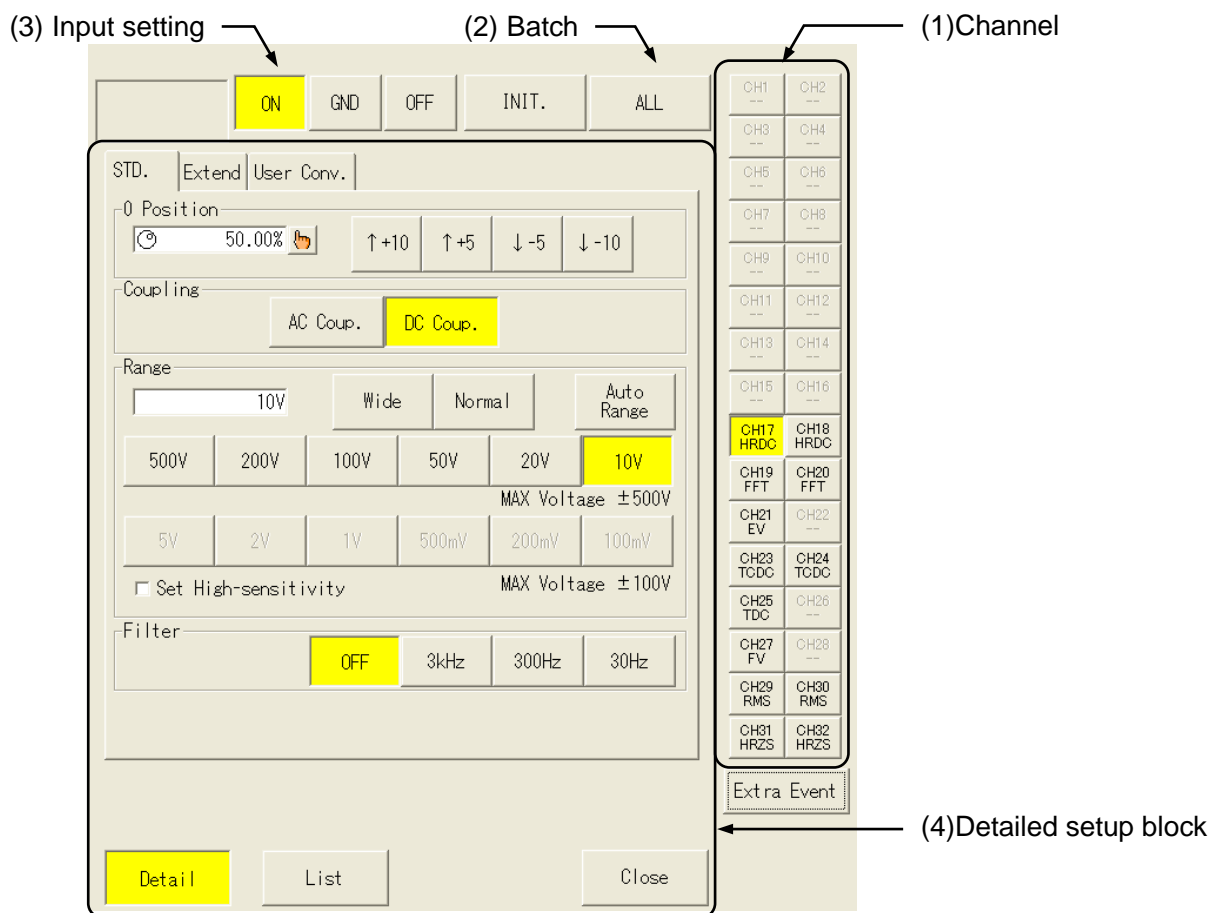

(1) Channel

Channel to be set up is selected. Pressing a button changes the contents of (4) Detailed setup block..

(2) Batch

Batch setting for the same type of amp can be made. Pressing the button highlights this button, indicating the batch setup is effective. In addition, the Channel buttons of target channels of batch setup highlight, too. If specific channels should setup through batch setup, cancel the highlight of the channels by pressing the Channel button that will not be set. To set through the batch setup, highlight the target channels again.

NOTE

Only the same type of units can be set through the batch setup.

(3) Input setup

ON, OFF, and GND for input is set. GND may not be provided depending on the amp. If the input is set to OFF, neither waveform nor digital values are displayed.

(4) Detailed settings

Contents differ depending on the amp type. Refer to the description of each amp type.

7.1.3. Recorder Event Detailed Screen

Changes can be made for the Event Unit of the RA2800A unit by pressing EXT EV on the [Tab] key.

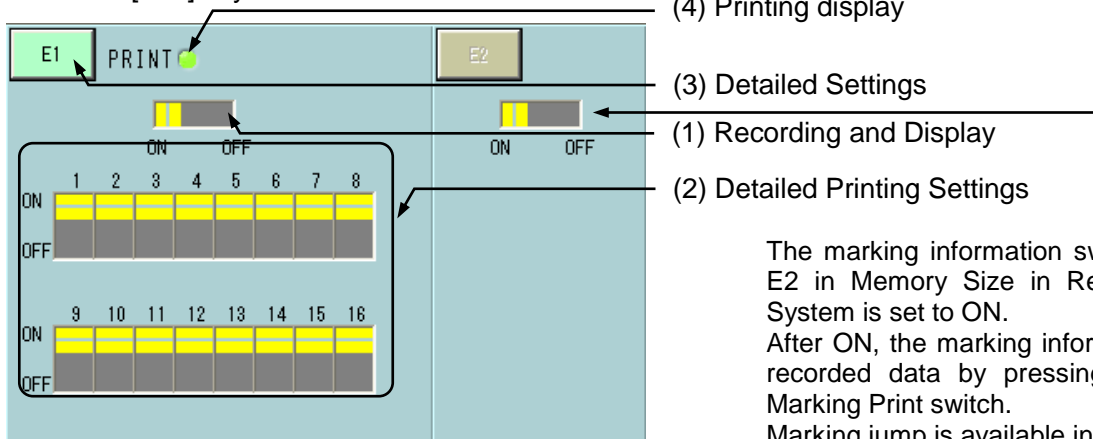

The marking information switch can be set when E2 in Memory Size in Recording Conditions in System is set to ON.

After ON, the marking information is added to the recorded data by pressing the Manual Trigger Marking Print switch.

Marking jump is available in the replayed screen.

14.6.5 Event Jump

(1) Recording and Display

Recording and display ON/OFF can be set for all 16 event signals

(2) Detailed Printing Settings

Display ON/OFF for all 16 event signals can be set. (4) Only ON is effective for Printing.

(3) Detailed Settings

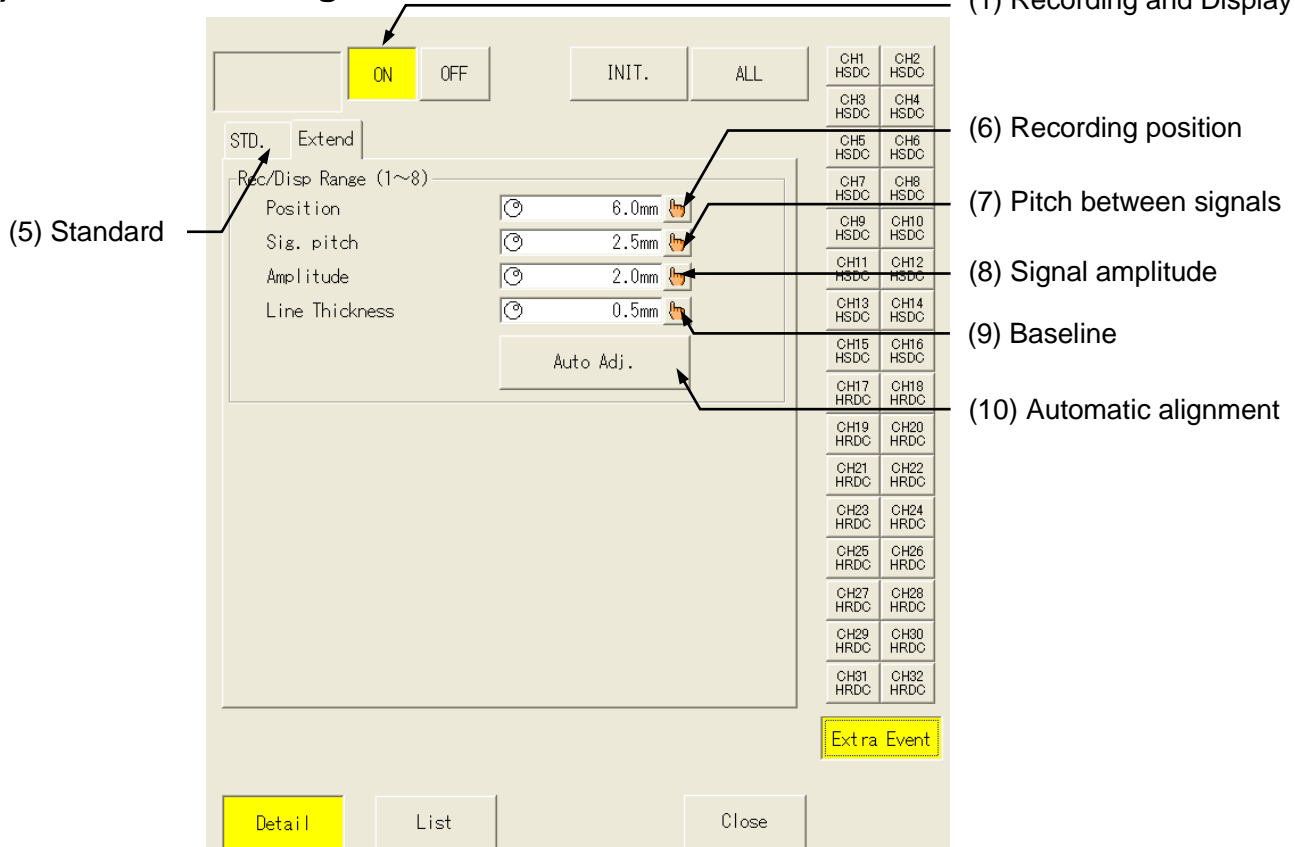

(4) Printing display

ON/OFF status is displayed in the event waveform printing channel setup. Setting cannot be made.  See 15. Display and Printing

(5) Standard

ON/OFF for event waveform recording for each channel among 16 signals can be set. The ON/OFF setup result is reflected on the Event Detailed Screen.

(6) Recording position

Waveform position for events 1 to 16 can be specified. The position for each event is the interval specified by the pitch between signals and allocated to the upper side or left side.

(7) Pitch between signals

Waveform interval for event 16 is specified.

(8) Signal amplitude

Waveform amplitude (waveform amplitude at H/L change) for event 16 is specified.

(9) Baseline

Waveform width at H is specified.

(10) Automatic alignment

Event waveform recording is automatically aligned so that it matches with the grid.

NOTE

If the recording position and pitch between signals are set to be too large, event waveform printing cannot be made as the effective recording width is exceeded.

7.1.4. Connector/Pin Alignment

8-Pins DIN Connector (as seen from the inserting side of the plug)

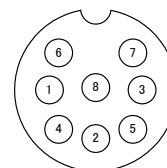

Specification

Voltage input	range of input voltage	0 - +24 V
	detection levels	H-level: more than 2.5V approximately L-level: less than 0.5 V approximately
	input current	no more than 1 μ A
Contact input	detection levels	open: no less than 2 k Ω short: no more than 250 Ω
	load current	2 mA (MAX)

Pin assignment

Connector 1 - 4		Connector 5 - 8		Connector 9 - 12		Connector 13 - 16	
Pin No	Signal assignment	Pin No	Signal assignment	Pin No	Signal assignment	Pin No	Signal assignment
1	ch 1 input	1	ch 5 input	1	ch 9 input	1	ch 13 input
2	ch 2 input	2	ch 6 input	2	ch 10 input	2	ch 14 input
3	ch 3 input	3	ch 7 input	3	ch 11 input	3	ch 15 input
4	ch 4 input	4	ch 8 input	4	ch 12 input	4	ch 16 input
5	ground	5	ground	5	ground	5	ground
6	+15 V output	6	+15 V output	6	+15 V output	6	+15 V output
7	not connected	7	not connected	7	not connected	7	not connected
8	not connected	8	not connected	8	not connected	8	not connected

NOTE

The slide switch on the rear panel is used to select VOLTAGE event or CONTACT event.

7.1.5. Restriction of Printing in Event Amp

Up to 16 units of Event Amp AP11-105 can be installed in the RA2800A but the display and printing can be made for only 8 units.
Refer to the combination below.

Event Amp Installation Slot																Printable Event								
1	3	5	7	9	11	13	15	17	19	21	23	25	27	29	31	E1	1	3	5	7	9	11	13	15
○	○	○	○	○	○	○	○	○	○	○	○	○	○	○	○	○	1	3	5	7	9	11	13	15
○		○		○		○		○		○		○		○		○	1	5	9	13	17	21	25	29
	○		○				○		○	○	○	○				○	3	7	15	19	21	23	25	—
○	○	○	○	○	○											○	1	3	5	7	9	11	E _H	E _L

E1 indicates the recorder event.

E_H indicates upper eight events of the recorder event.

E_L indicates lower eight events of the recorder event.

To change the unit for printing with eight or more event amps installed, follow the steps below.

(1) Event amp basic screen

After displaying the [Amp] screen by pressing the Amp button on the Operation Panel, press Detailed Settings of the unit whose settings are to be changed.

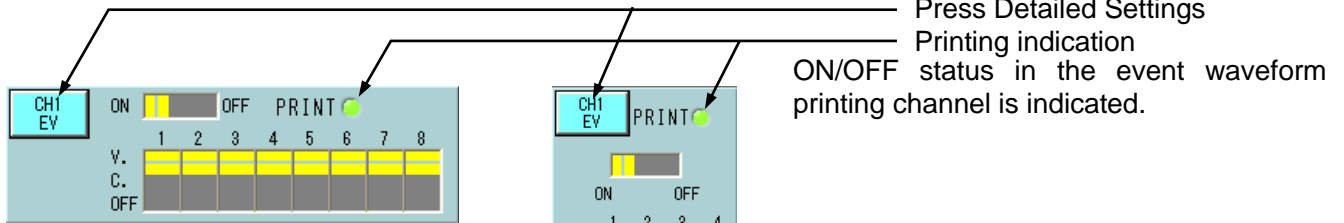

Display scrolling direction: Horizontal screen

Display scrolling direction: Vertical screen

(2) Event Amp Detailed Screen

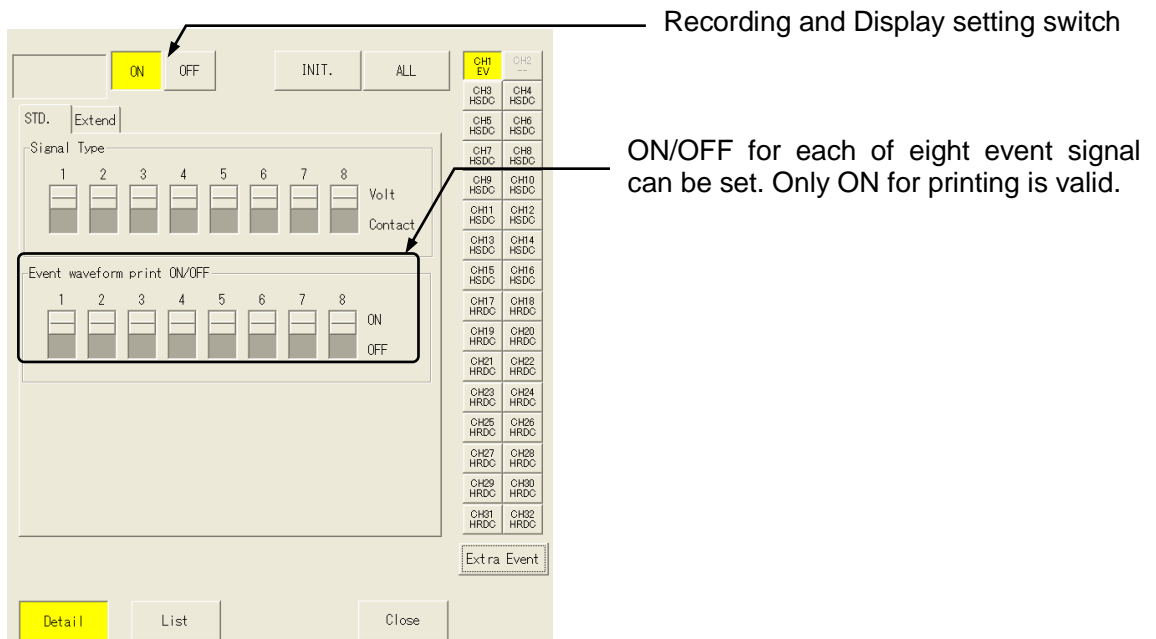

**8. *Pen Recorder
Recording Low-speed
Signal for Long Time***

8.1 Overview of Pen Recorder Mode

The Pen Recorder mode offers a pen recorder function, which is dedicated to waveform printing. Chart feed speed and amp settings are made on a screen, which are exactly equivalent to the operability of a pen recorder.

To set the recorder main unit to the Pen Recorder mode, use Measurement Mode tab in the System screen. Measurement mode setting is made on the Startup screen that is displayed upon the startup. (Depending on the startup screen, the Startup screen may not be displayed.)

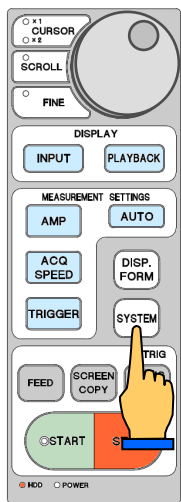

Operation panel

Measurement mode selection

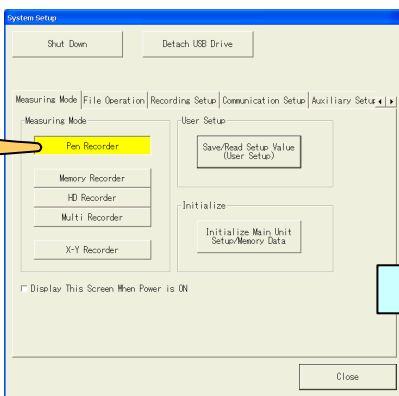
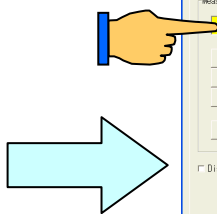

System screen

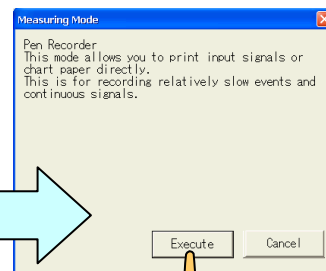

Press Execute.

Setup completes after the mode turns to yellow after execution.

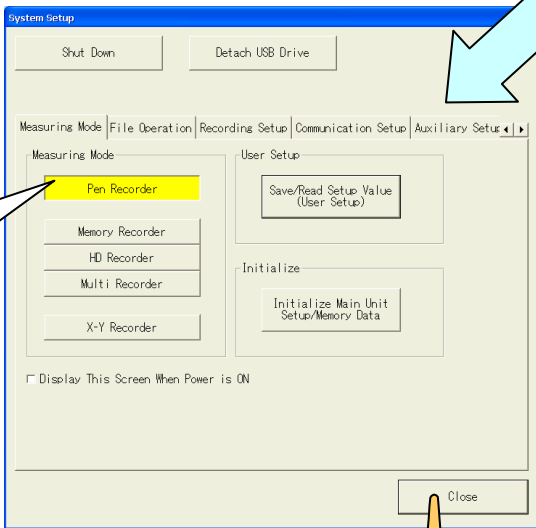

Pressing Close closes the Setup screen. The mode setting completes after the screen is switched.

NOTE

As the Pen Recorder mode only performs waveform printing on a chart recording paper, Even the Input Signal, Amp, Recording Condition, and Trigger buttons are pressed, the screen display does not change.

8.2 Screen Operation

Open the following screen by pressing one button among Input Signal, Amp, Recording Condition, and Trigger buttons in the Pen Recorder mode.

Display scrolling direction: Horizontal screen

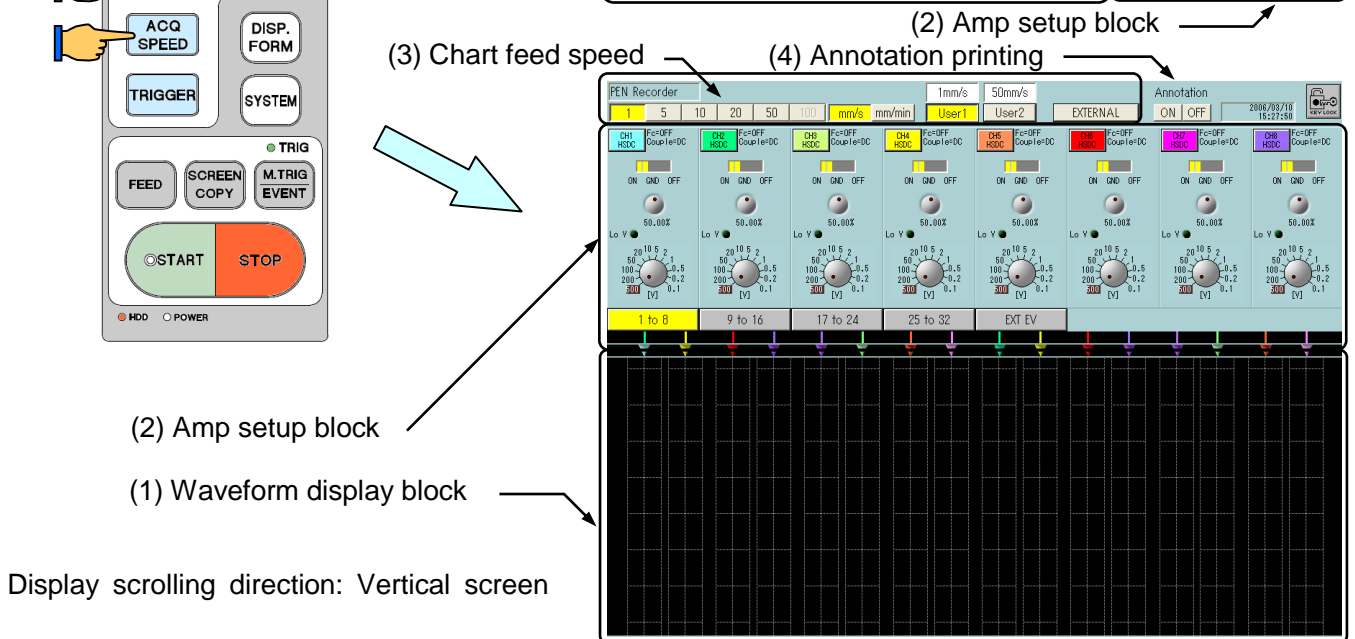
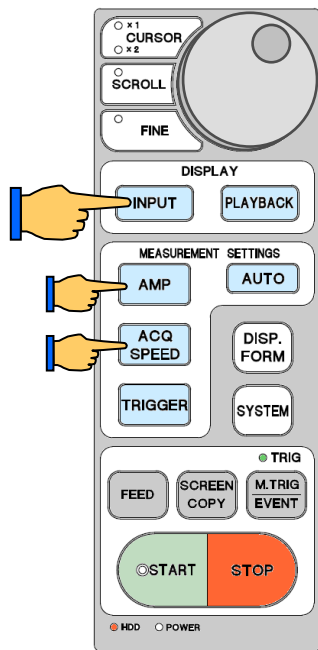
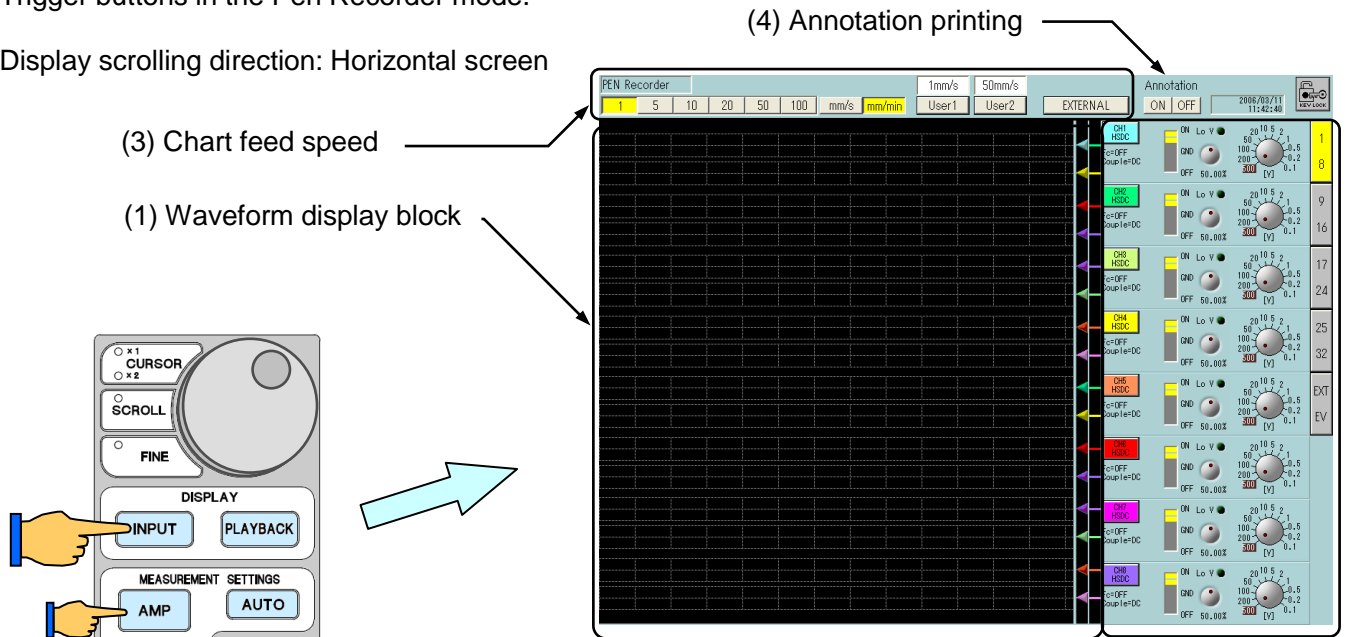

Display scrolling direction: Vertical screen

(1) Waveform display block

Input signals are displayed in this block. The basic functions are almost same as the Input Monitor. The signal monitoring speed in this block is the same as the chart feed speed. For more details, see Chapter 5. Observing Input Signal.

(2) Amp setup block

This block is used to set amp unit. For more details, see Chapter 7. Amp Units

(3) Chart feed speed

These buttons are used to set chart recording paper feed speed. Value is set by pressing a button. The maximum chart feed speed is 50 mm/s. Through User 1 and User 2 buttons, user can set arbitrary feed speeds. For more details, see Chapter 16 System Setup

(4) Annotation printing

ON/OFF for annotation printing can be set.
For more details, see 16. System Setup.

8.3 Printing Operation

Pressing the Start button on the Operation Panel starts printing. Pressing the Stop button stops printing.

Sample printing

- (1) Waveform printing
- (2) System annotation (above)
- (3) Mark printing
- (4) Signal name
- (5) Scale

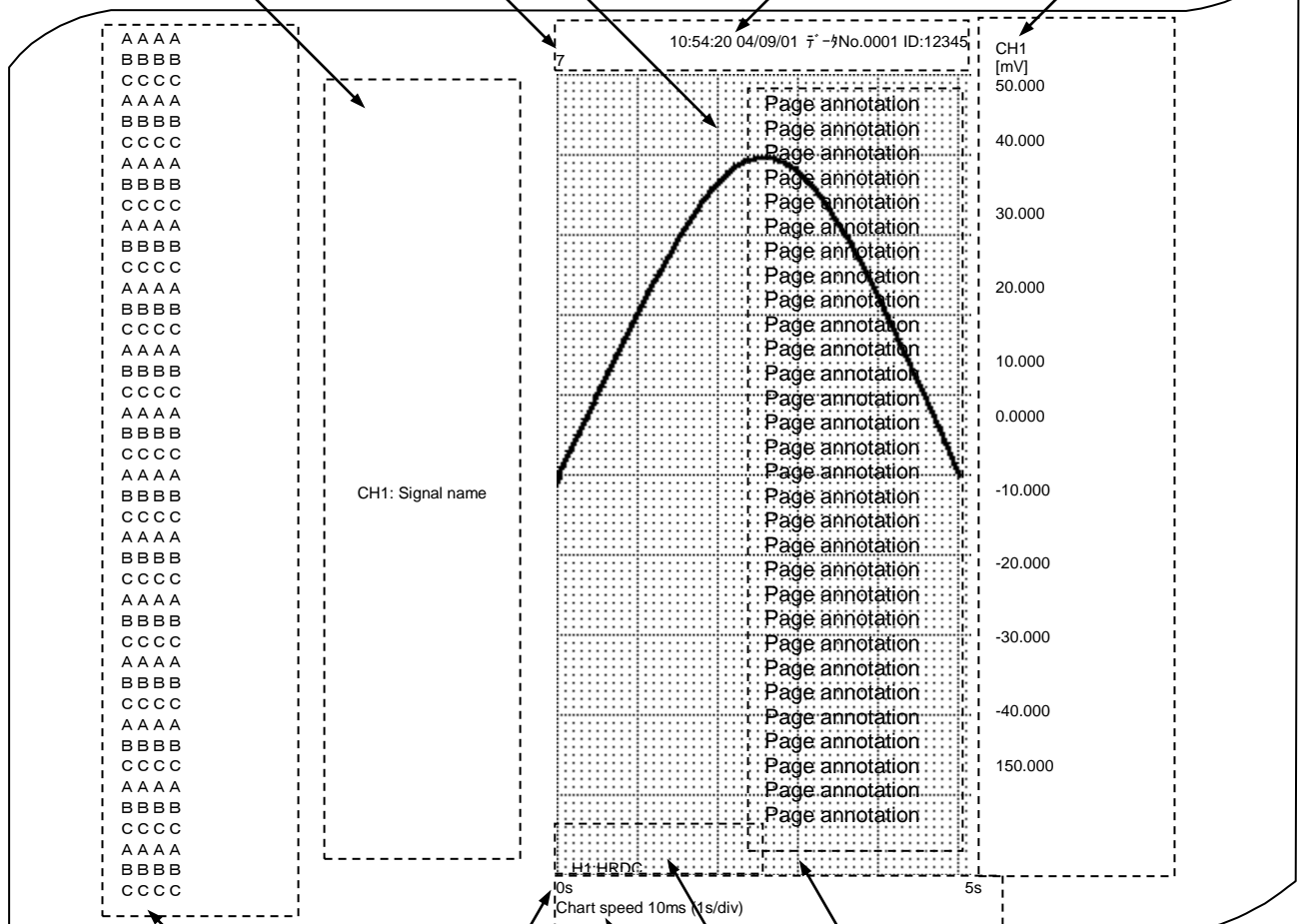

- (6) Time axis
- (7) Measurement information
- (8) Page annotation
- (9) Channel annotation
- (2) System annotation (below)

(1) Waveform printing

Input signals are printed in a form of waveform. The same waveforms as those displayed in the monitor are printed. Waveform segmentation and grid pattern can be set.

For more details, see Chapter 15. Display and Printing

(2) System annotation (above/below)

System information related to printing is printed. Print start time is indicated on the top of the recording paper and print speed is indicated on the bottom of the recording paper.

Data No.: Automatically added number by printing is printed.

ID number: Recorder serial number is printed.

(3) Marking

Marking is printed by pressing the Marking button on the Operation Panel during recording..

Marking time is also printed after ↓M.

Example: 17:06:20 2004/11/29

(4) Signal name

Character strings set by user by channel are printed. The position of printing is near the zero level of each signal. If the annotation printing position overlaps with a signal waveform, the annotation is printed at above or below the waveform. If annotation cannot be printed within in the waveform printing range, the annotation printing is omitted.

For printing ON/OFF for signal name and character string settings,  see Chapter 16. System Setup.

(5) Scale

Analog waveform amplitude scale is printed. Printing OFF and scale printing format can be changed with settings.

For details of scale settings,  see Chapter 16. System Setup.

(6) Time axis

Time axis scale is printed below the waveform printing grid. Printing ON, OFF, and format (e.g. value and time) can be set.

For more details on settings,  see Chapter 16. System Setup.

(7) Measurement information

Character strings specified by user are printed before waveforms are printed.

To set printing ON, OFF, or character strings,  see Chapter 16. System Setup.

(8) Page annotation

Following system annotation, character strings defined by user are printed over waveform printing. To set printing ON, OFF, or character strings,  see Chapter 16. System Setup.

(9) Channel annotation

Recording condition by signal is printed.

8.3.1 Stop Due to Error

Printing stops in the following cases.

- **Chart paper-out**

In the case where chart paper run out, printing cannot be made. In this case, printing is terminated. When red marks at the both sides of the chart recording paper, prepare new chart recording paper as they signifies paper-out.

- **Thermal head over-heating**

If the thermal head for printing is heated too much, operation stops due to error. If printing of entire screen is repeatedly made, the temperature of the thermal head at printing block rises. In this case, the recorder automatically controls the print density, thereby prohibiting temperature rise. However, if the ambient temperature is so high or heat release is not made smoothly, thermal head temperature excessively rises. In such case, printing is terminated due to error so as to prevent fire breakout.

9. Memory Recorder Recording High-speed Signals

9.1. Overview of Memory Recorder Mode

The Memory Recorder mode is useful for recording high-speed signals (Maximum recording speed of 2 μ s) since this mode features a highest sampling rate of 1 μ s. Data recording of a certain period of time before trigger is available. Automatic printing of data on chart recording paper (Auto Copy) or file saving (Backup Filing) is also available. In addition, replay of waveforms on the monitor is possible.

To set the RA2300 to the Memory Recorder mode, use the Measurement Mode tab on the System screen. Mode setting can also be made on the Startup screen that is displayed upon the startup. (Depending on the startup screen, the Startup screen may not be displayed.)

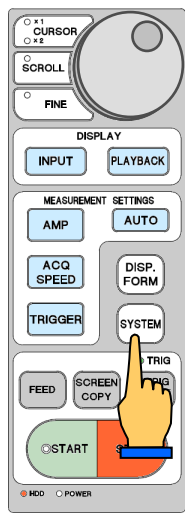

Operation panel

Measurement mode selection

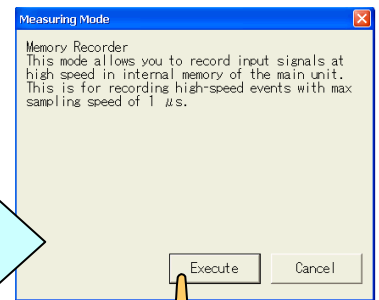
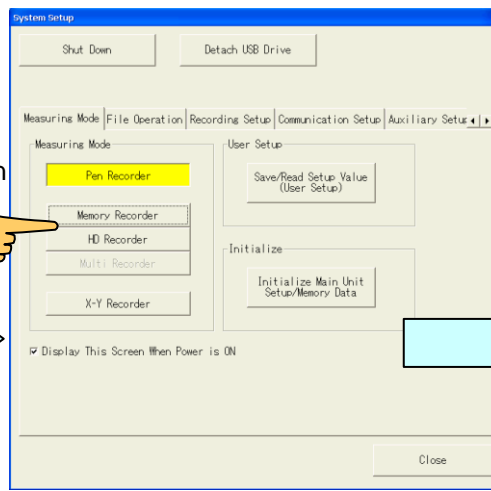
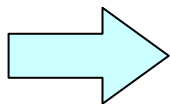

Press Execute.

Setup completes after the mode turns to yellow after execution.

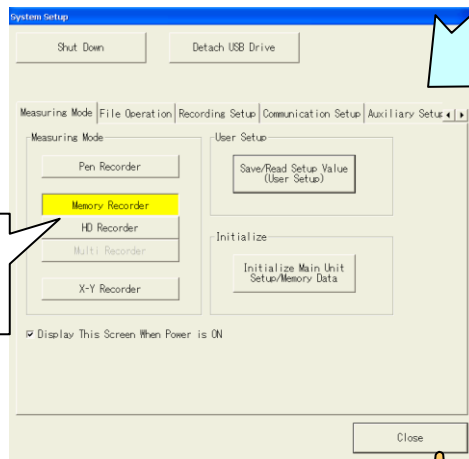

Pressing Close closes the Setup screen. The mode setting completes after the screen is switched.

9.2. Recording Condition Setup

Open the following screen by pressing the Recording Condition button on the Operation Panel to set the recording conditions for Memory Recorder. The recording condition setup should be made while the recorder stops its operation. Setup can be made during recording.

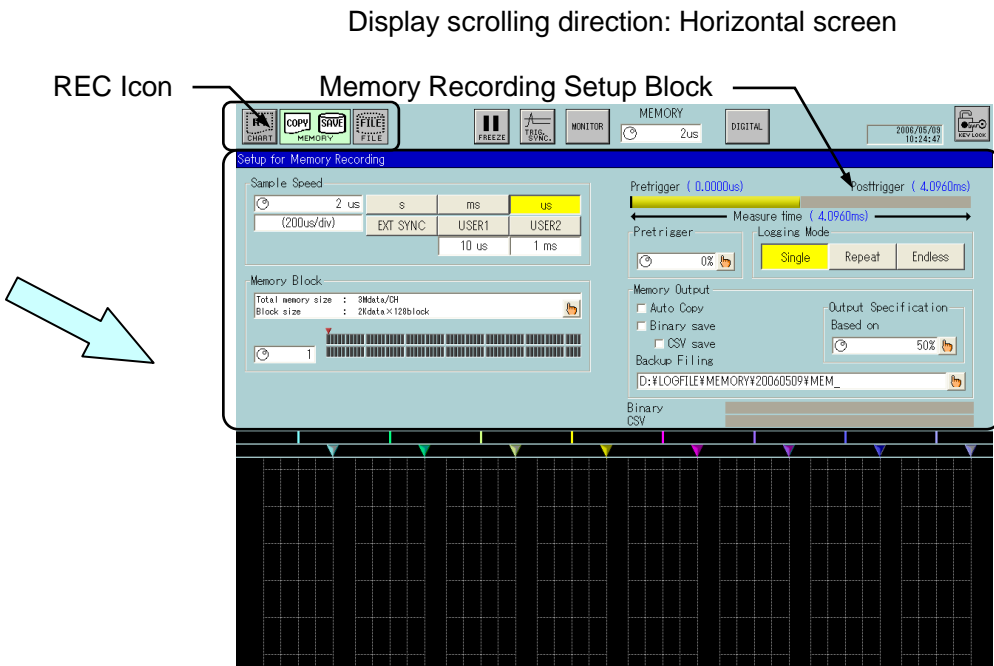
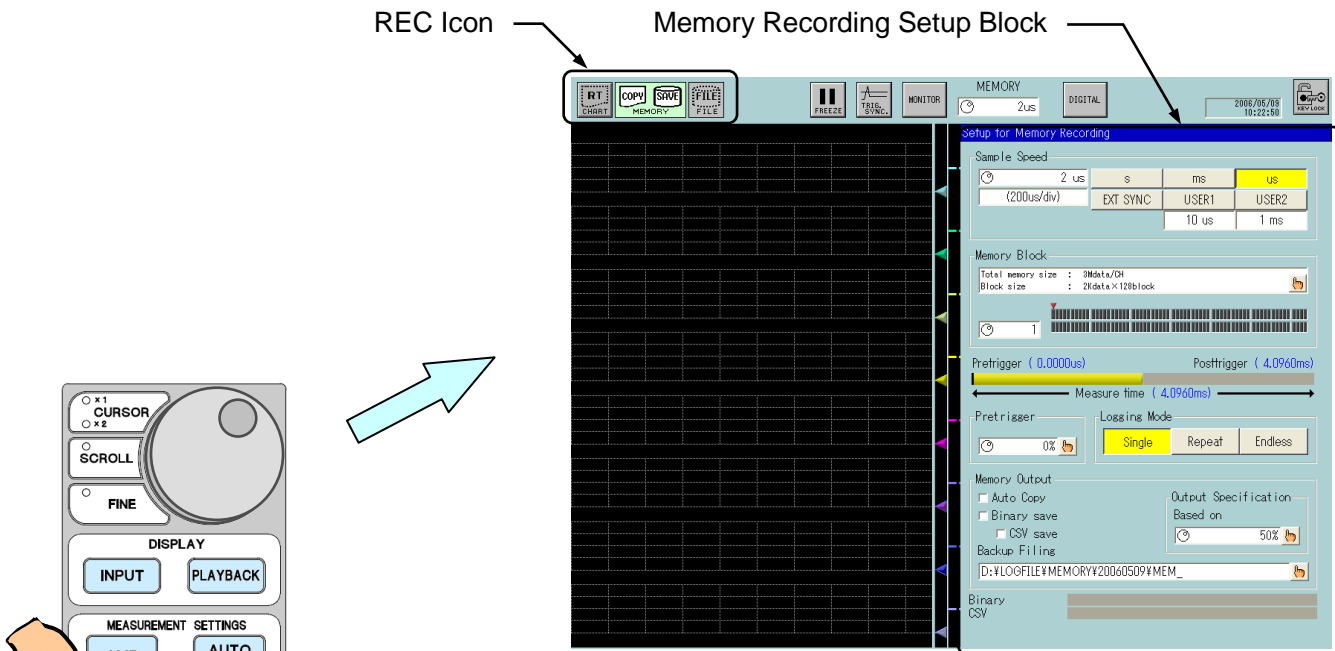

9.2.1. Description of Icons

The icons signify recording settings and status.

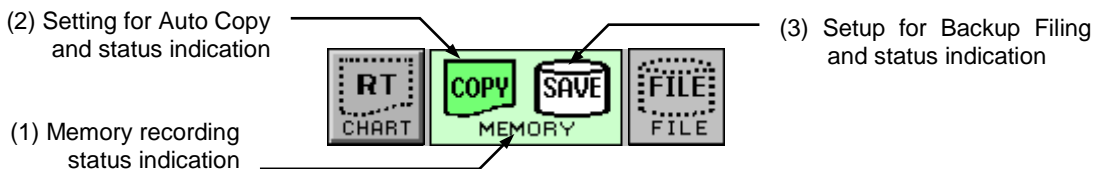

	(1) Memory Recording	(2) Auto Copy	(3) Backup Filing	(4) Others
Stop OFF (White)				As waveform chart printing, HD recording does not operate, no indication is made.
Stop ON (Green)				
Trigger wait (Yellow)		None	None	
Measuring (Amber)				
Error (Red)				

9.2.2. Memory Recording Condition Setup Block

Display scrolling direction: Horizontal screen

Setup for Memory Recording

(1) Sample Speed: 10 us, (1.000ms/div), EXT SYNC, USER1, USER2, 10 us, 1 ms

(3) Memory Block: Total memory size : 3Mdata/CH, Block size : 2Kdata×128block, (2)

(4) Pretrigger (10.240ms), Posttrigger (10.240ms), Measure time (20.480ms)

(5) Pretrigger: 50%, Logging Mode: Single, Repeat, Endless (6)

(7) Memory Output: Auto Copy, Binary save, CSV save, Output Specification Based on: 50% (8)

(9) Backup Filing: D:\LOGFILE\MEMORY\20050901\MEM_ (9)

(10) Binary CSV (10)

- (1) Sampling rate
- (2) Memory Block Size
- (3) Memory Block & Status Indication
- (4) Sample recording image
- (5) Pre-trigger
- (6) Memory Recording Operation
- (7) Auto data output
- (8) Output range
- (9) File output path
- (10) Indicator for file saving situation.

Display scrolling direction: Vertical screen

Setup for Memory Recording

(1) Sample Speed: 2 us, (200us/div), EXT SYNC, USER1, USER2, 10 us, 1 ms

(3) Memory Block: Total memory size : 3Mdata/CH, Block size : 2Kdata×128block, (2)

(4) Pretrigger (0.000us), Posttrigger (4.0960ms), Measure time (4.0960ms)

(5) Pretrigger: 0%, Logging Mode: Single, Repeat, Endless (6)

(7) Memory Output: Auto Copy, Binary save, CSV save, Output Specification Based on: 50% (8)

(9) Backup Filing: D:\LOGFILE\MEMORY\20060509\MEM_ (9)

(10) Binary CSV (10)

(1) Sampling rate

Sampling rate for memory recording is set.

(2) Memory block size

Memory recording block size is displayed.

Pressing a setup button opens a setup dialog box.

Select a memory size

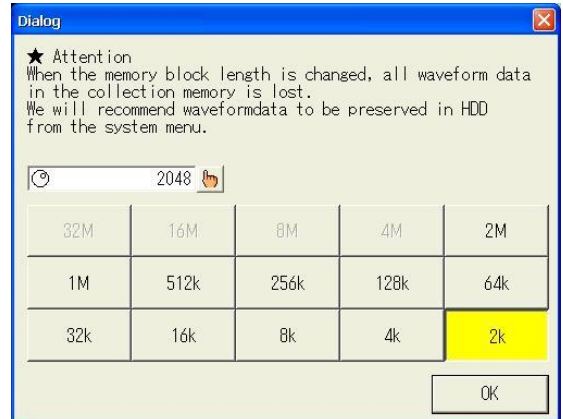

NOTE

Memory block size can be expanded to more than 4 MW by limiting the number of channel for recording..

To limit the number of channel for recording see 16. System Setup.

(3) Memory block and status indication

Block number to be recorded and data existence is indicated. Block number can be changed using the jog dial.

Reference for Memory Block color:

Black: Data is not recorded in Memory.

Orange: Data is being recorded in Memory

Yellow: Data recording in Memory is completed

(4) Recording sample

Trigger position for entire recording and sample for output range is displayed. Recording time: Pre-trigger and post-trigger and total recording time is displayed.

(5) Pre-trigger

Recording size before trigger can be set in percentage. Changing this setting renews the sample recording image, which enables a user to confirm recording time allocation.

NOTE

If a trigger is detected immediately after the start of recording, the data length satisfying the specified data size cannot be recorded.

Example: Under pre-trigger setup of 30 ms, a trigger is detected 10 ms after the start of recording. The pre-trigger recording data length is 10 ms, resulting in shorter data length than pre-set length.

If the Stop button is pressed shortly after a trigger is detected, only the data having the length shorter than recording time is displayed in the sample recording image is recorded.

Example: Under post-trigger setup of 50 ms, if the Stop button is pressed 30 ms after the trigger detection, the recording length after the trigger is 30 ms, resulting in shorter data length than pre-set length.

(6) Memory recording operation

These buttons are used to specify the memory recording operation.

Recording operation	Description
Once	Operation closes after recording of one block is finished.
Repeated	Recording operation repeats for the number of blocks. It finishes when all blocks are recorded.
Endless	Recording operation repeats for the number of blocks. After recording of all blocks, overwriting from the top is repeated. Recording stops when the Stop button on the Operation Panel is pressed.

(7) Auto data output

This portion specifies data output after memory recording.

Output format	Description
Auto Copy	This function prints out the waveforms area, which is specified by output range.
Binary Save	All data region is saved as a file with the FSD extension.
CSV Save	Area that is specified through output range is saved in the CSV format.

NOTE

The binary save performs saving of entire part of file regardless of output range settings. When performing the CSV save, always execute the binary save.

For more details on the CSV save, see Chapter 14. Replay Display.

(8) Output range

Data output range for Auto Copy and CSV save is specified. Auto copy is affected by the scale factor of time axis on display monitor. The setting is made in % in reference to the trigger detection point.

(9) File output path

The file save target path can be specified. Pressing the button opens the following dialog box.

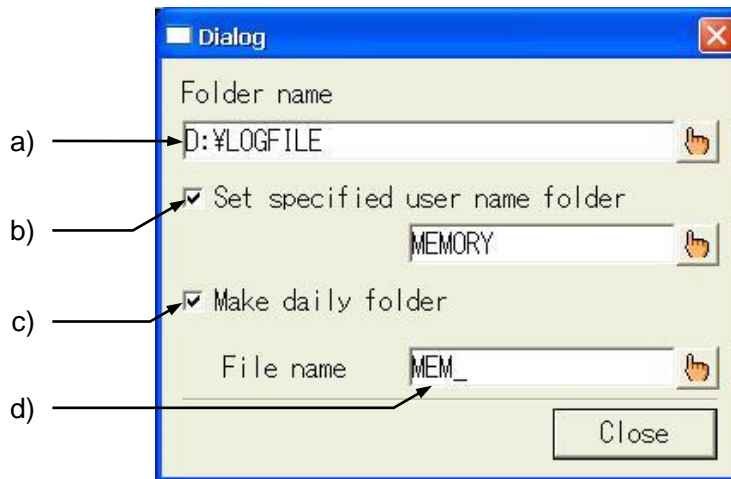
**a) Save target path**

Save target path is specified. As well as internal HDD, USB storage drive can be specified.

b) ON/OFF for folder made by user

When the check box is ticked, a folder can be made by user. The data save destination will be under the folder.

c) ON/OFF for creating folder everyday

When the check box is ticked, starting time is referenced and folder is created everyday. The data save destination will be under the folder.

d) Arbitrary file name (Limited to the top four letters)

Top four letters for the save file is designated. The file name will have designated top four letters and four-digit serial number. The extension has "fsd" for the binary save and "csv" for the CSV save.

(10) Indicator for file saving situation.

Data saving situation for both Binary and CSV formats is displayed.

9.3. Recording Operation

Pressing the Start button on the Operation Panel starts the Memory Recording. After the recording start, the recorder is in the wait status for trigger detection. Pressing the Stop button stops the operation forcibly. The following diagram explains the flow of operation.

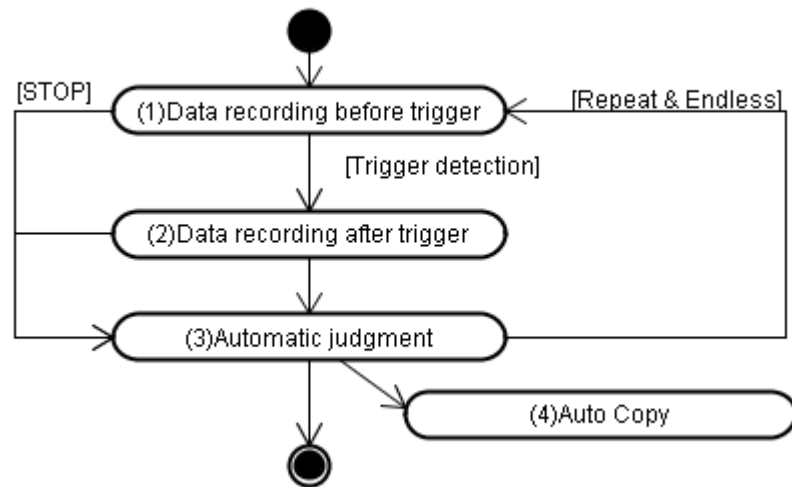

(1) Data recording before trigger

After the memory recording start, trigger detection wait status starts. Memory block recording continues until the trigger detection is made or the Stop button is pressed. When the trigger is detected, data recording operation starts after the trigger. When the Stop button is pressed and operation is forcibly terminated, the trigger recording is not made but the operation judgment processing starts.

NOTE

Other than trigger detection by an input signal, trigger detection can be made through the Manual Trigger or External Trigger signal. For details on trigger condition settings, see 13. Trigger Setup.

NOTE

If the Stop button is pressed and forcible termination is made before the trigger detection, data recording is made up to the size set by the pre-trigger. Example: Under pre-trigger of 20 ms, if the recording is forcibly terminated before the trigger detection, the recording length is up to 20 ms.

(2) Data recording after trigger

The amount of data specified by the pre-trigger is retained and recording for remaining amount of data is made. The recording automatically ends but forcible termination is also made through the Stop button. In this case, the data length will be shorter than the data length displayed as recording time.

(3) Automatic judgment

When Auto Copy and Backup Filing are selected to be effective, automatic data output of recording data is made. Memory block recording is repeated depending on the recording operation.

NOTE

If forcible termination is made with the Stop button, memory recording finishes without repeated endless operations.

NOTE

If the block for overwriting is outputting data in endless manner, recording starts after the outputting is completed.

(4) Auto Copy

Auto Copy and Backup Filing are executed.

10. HD Recorder

Recording Data in Internal HDD

10.1. Overview of HD Recorder Mode

The HD Recorder mode can record data in the internal hard disk, which is suitable for a long-time measurement. In addition, waveform chart paper printing can be made with the HD recording at the same time. The data recorded in the HD can be replayed on the monitor screen in the form of waveforms.

To set the recorder in the HD Recorder mode, use the Measurement Mode tab in the System screen. Settings of measurement mode can be made on the Startup screen displayed upon the startup. (*The startup screen does not appear depending on the setup.)

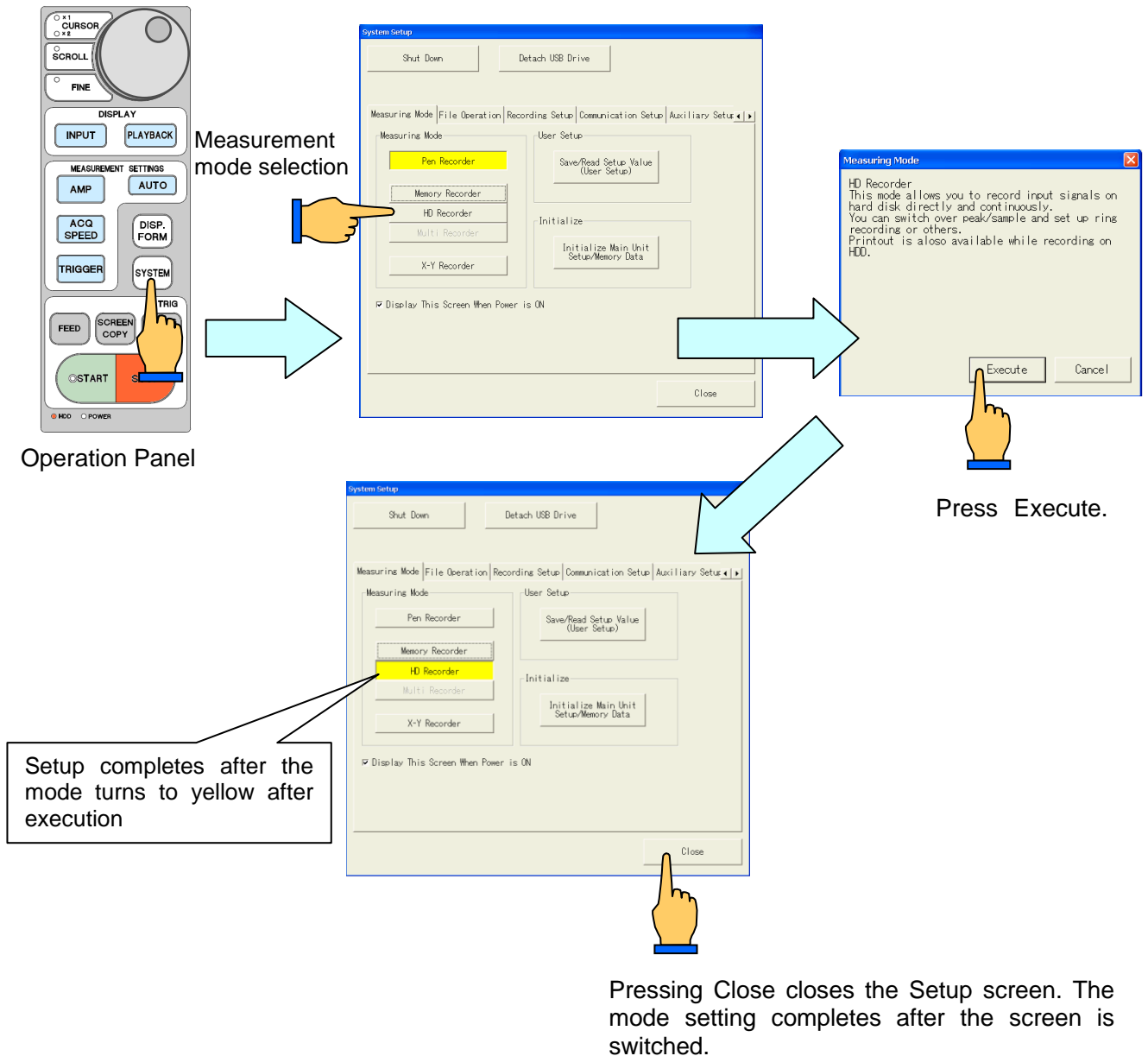

NOTE

The drive for data recording is fixed to the internal HDD only. For details on data output to the USB storage, see Replay Screen - Data Output or System - File Operation.

10.2. Recording Condition Setup

Open the following screen by pressing the Recording Condition button on the Operation Panel to set the recording conditions for HD Recorder. The recording condition setup should be made while the recorder stops its operation. Setup can be made during recording.

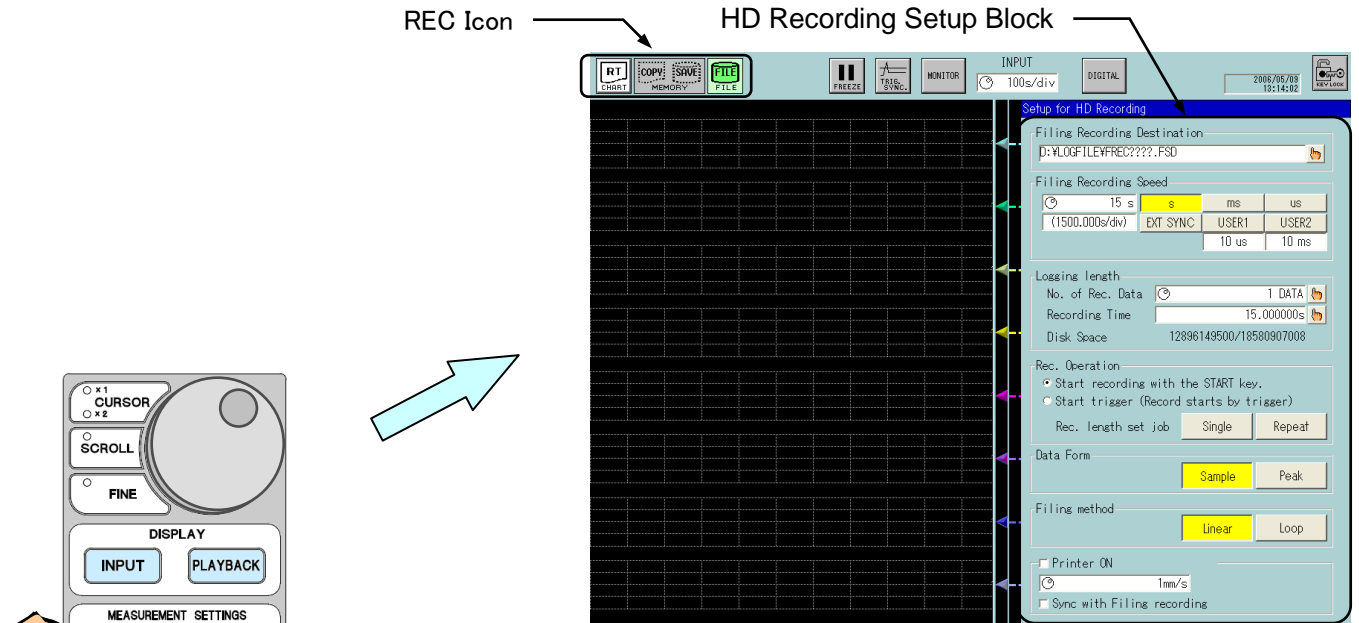

Display scrolling direction: Horizontal screen

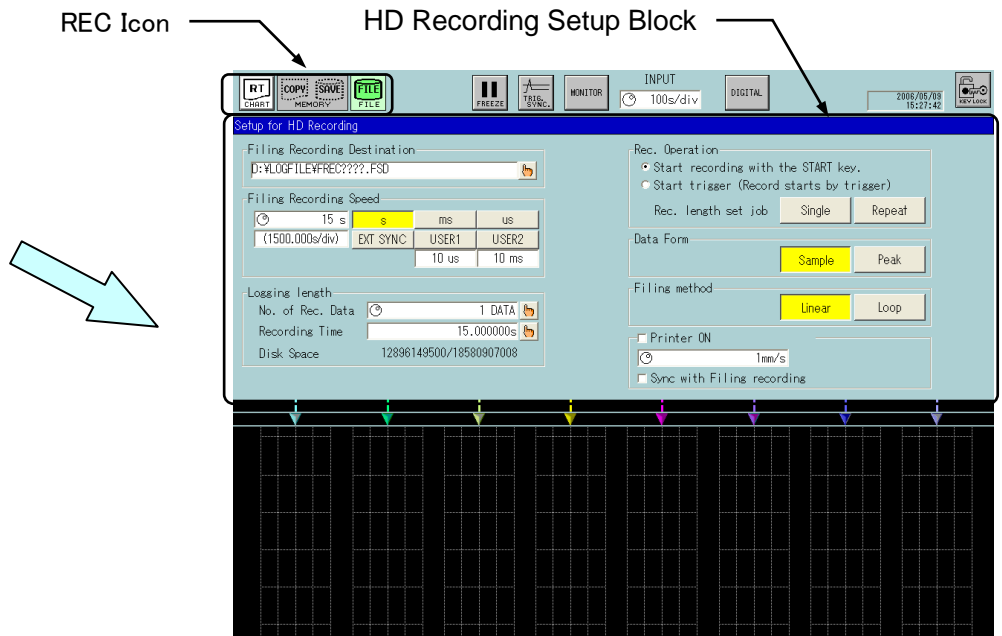

Display scrolling direction: Vertical screen

10.2.1. REC Icon

The icons signify recording status.

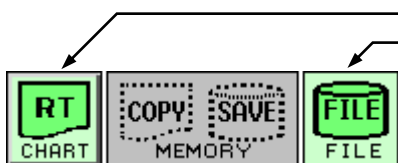

- (1) Waveform chart printing setup and status display
- (2) HD recording status indication

	(1) Chart Printing	(2) HD Recording	(3) Others
Recorder stop OFF (White)			As memory recording does not operate, indication is invalid.
Recorder stop ON (Green)			
Trigger wait (Yellow)	None		
Operating (Amber)			
Error (Red)			
Remark	The setup is possible only while the recording is recording data.		

10.2.2. HD Recording Setup Block

Setup for HD Recording

- Filing Recording Destination
D:\LOG\FILE\FREC
- Filing Recording Speed
1 s (100.000s/div) EXT SYNC USER1 USER2
10 us 10 ms
- Logging length
No. of Rec. Data Max length
Recording Time 20789day 22hour 44min 21s
Disk Space 39785967616/39999500288 (4)
- Rec. Operation
Starts recording with the START key.
Start trigger(Record starts by trigger)
Rec. length set job Single Repeat
- Data Form
Sample Peak
- Filing method
Linear Loop
- Printer ON
1mm/s
Sync with Filing recording

Display scrolling direction: Horizontal screen

- (1) File save path
- (2) Recording rate
- (3) Logging length
- (4) Free space in internal HDD
- (5) Rec. Operation
- (6) Data format
- (7) Filing format
- (8) Waveform chart printing

Setup for HD Recording

- Filing Recording Destination
D:\LOG\FILE\FREC?????.FSD
- Filing Recording Speed
15 s (1500.000s/div) EXT SYNC USER1 USER2
10 us 10 ms
- Logging length
No. of Rec. Data 1 DATA
Recording Time 15.000000s
Disk Space 12896149500/18580907008 (4)
- Rec. Operation
Start recording with the START key.
Start trigger (Record starts by trigger)
Rec. length set job Single Repeat
- Data Form
Sample Peak
- Filing method
Linear Loop
- Printer ON
1mm/s
Sync with Filing recording

Display scrolling direction: Vertical screen

(1) File save path

Save target path for HD recording is indicated. Pressing the button opens the next dialog box and the path can be set.

a) Save target folder

The save target folder is specified.

b) User name entry folder

When this box is ticked, a folder is created and the save target will become inside of this folder.

c) Make daily folder

When this box is ticked, a daily folder is made, and data is saved in the folder.

d) File name

Arbitrary file name (Limited to the top four letters)

Top four letters for the save file is specified. The file name will include designated top four letters and four-digit serial number. The extension has FSP for the sample format file, and FPP for the peak format file.



(2) Recording rate

Recording rate can be set.

Recording rate is restricted depending on both data format and number of channels, as shown in the table. below.

NOTE

Recording time changes if the recording speed is changed. Check before recording start.

(3) Recording length

The length of recording in HD is indicated in data count and

recording time. Setup can be made in the setup dialog box that is displayed when the button is pressed.

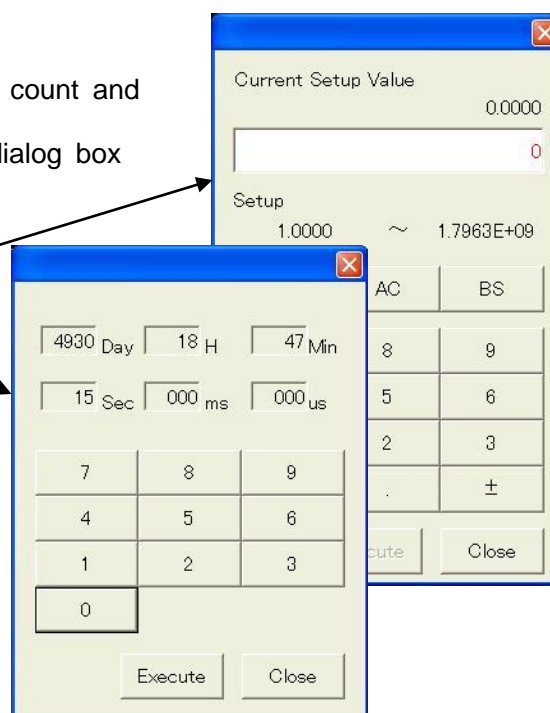

The recording time changes in conjunction with the change of the data count, and vice versa. The recording time can be determined by multiplying data number by sampling rate.

File size = Acquisition information + Data type x Acquisition channel

When the recording time is set to Maximum, recording is made up to the size of free space of HD. As a user does not need to take care of recording length, the Maximum is best choice when recording is made with Start and Stop.

NOTE

If free space is shortened during HD recording, operation stops with an error. In this case, shorter recording time than specified recording length of time will result. If recording data amount is set more than 2GB, stored, A, B, and C is added to the end of the file name.

(4) Indication of free space in internal HDD

It displays the number of the bytes with HDD free disk space and all capacity.

(5) Recording operation

HD recording operation can be made with trigger detection.

Setup item	Contents
Recording start with start button	When the Start button is pressed, recording begins.
Start trigger	After the Start button is pressed, recording starts upon trigger activation.
Marking upon trigger detection	While E2 is ON, up to newest 128 trigger points can be memorized. The marking points can be checked on the replay monitor.
Once	Recording operation completes after one recording action.
Repeated	HD recording repeats until the Stop button is pressed. However in the following cases, operation will be invalid because one recording automatically finishes. The recording mode is "Ring." The recording length is "Up to the size of free space."

NOTE

When a start trigger is set, there is a trigger mark at the beginning of file, because recording starts just after trigger detection.

(6) Data format

Setup item	Description
Peak	One data consist of two values: maximum and minimum values. Regardless of recording speed, peak data is stored with the highest A/D conversion speed of amp. It is possible to observe waveform having high-frequency element for long period of time.
Sampling	One data consist of one instantaneous value. The data number per one piece of data is half. Consequently, the recording speed and recording length will double.

(7) Filing mode

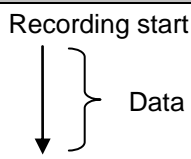
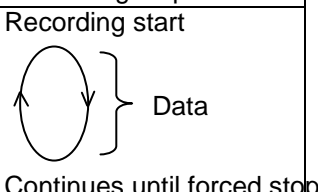
Setup item	Description
linear	Operation stops when specified number of data is recorded. 
Loop	Overwriting for specified number of data is made. (Overwriting is made from old data.) The operation stops when the Stop button is pressed. 

(8) Waveform chart printing

Settings related to waveform chart printing are made.

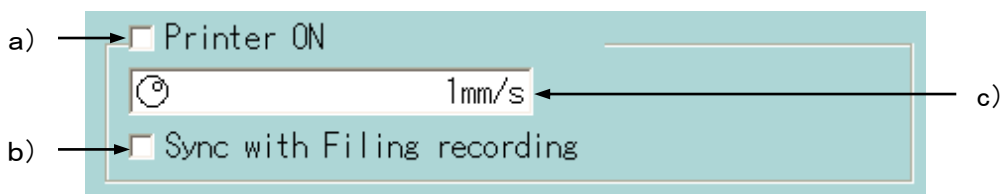

a) **Waveform ON/OFF**

ON/OFF for waveform chart printing is made. Changes during operation cannot be made.

b) Same printing speed as recording speed

When the check box is ticked, the waveform chart printing speed is automatically set to the speed the same as current recording speed. To separate the recording speed from the chart feed speed, do not check this box.

NOTE

The highest chart feed speed is 50 mm/s. If the recording speed is higher than this speed, the printing is made in the highest printing speed.

c) Chart feed speed setup

When the check box for “Same printing speed as recording speed” is not ticked, the chart feed speed is separated from the data recording speed.

10.3. Recording Operation

Pressing the Start button on the operation panel starts HD recording. While recording is made, pressing the Stop button forcibly stops the recording.

10.3.1. Start of Measurement

Pressing the Start button on the operation panel starts HD recording. If the setup in which the start of recording is initiated with a trigger signal, the start of recording is made with a trigger detection.

NOTE

If the combination of recording speed, recording length, data type, and recording channel count is not covered by recorder specifications, recording cannot be made and operation finishes with an error.

For HD recording, see 10.4 HD Recording Specifications.

10.3.2. To Finish Measurement (Forced Termination)

Pressing the Stop button on the Operation Panel executes forced termination. If recording length is specified, operation completes when specified number is recorded.

10.3.3. Waveform Chart Printing

During HD recording, waveform chart printing is started and stopped as necessary. Moreover, chart feed speed can be changed.

For operation, see 10.2 Recording Condition Setup.

10.3.4. Upon Error Generation

Errors may be generated and operation during HD recording

Generated error	Operation
File error	HD recording finishes with an error. If waveform chart printing operates, operation continues.
Paper-out error	HD recording continues. Waveform chart printing finishes with an error. Printing is restarted after the chart paper is filled.

10.3.5. Display of recording data

The Replay screen is used to display the data recorded in memory or file. For more details, please refer to “14. Replay Display”.

10.4. HD Recording Specifications

10.4.1. Recording File Size Calculation

This section covers how to calculate file capacity in HD recording. The file size can be calculated using the following parameters.

Parameter	Remark
Recording length	Recording data count
Data type	One data is saved in two bytes. Peak: 4 bytes due to two values (max. and min.) Sampling: 2 bytes due to instantaneous value
Recording channel count	Number of channels whose recording operation is set to ON (or GND). If event inputs are targeted, two channels is available in each channel.
Recording information	Recording information save size: 8,192 bytes * Size may be increased in future as the design is based on the assumption of future expansion.

$$\text{File size} = \text{Acquisition information} + (\text{Data type} \times \text{Acquisition channel})$$

Example: Recording length = 100,000, Data format = peak, Number of recording channel: 32
 Size = 8,192 + (100,000 x 4 x 32) = 12,808,192 (bytes)

10.4.2. Recording Speed Execution Restriction

The following restriction may be subjected in settable range in HD recording rate depending on the data format and the number of recording channels

For mat	Recording rate	Number of recording channel											
		1	2	3	4	5	6	7	8	9-16	17-32	34	
Sampling	22μs	OK	OK	OK	OK	OK	OK	OK	OK	OK	OK	OK	OK
	20μs	OK	OK	OK	OK	OK	OK	OK	OK	OK	OK	OK	NG
	10μs	OK	OK	OK	OK	OK	OK	OK	OK	OK	OK	NG	NG
	5μs	OK	OK	OK	OK	OK	OK	OK	OK	NG	NG	NG	NG
	4μs	OK	OK	OK	OK	OK	OK	OK	NG	NG	NG	NG	NG
	2μs	OK	OK	OK	NG	NG	NG	NG	NG	NG	NG	NG	NG
Peak	42μs	OK	OK	OK	OK	OK	OK	OK	OK	OK	OK	OK	OK
	40μs	OK	OK	OK	OK	OK	OK	OK	OK	OK	OK	OK	NG
	20μs	OK	OK	OK	OK	OK	OK	OK	OK	OK	OK	NG	NG
	10μs	OK	OK	OK	OK	OK	OK	OK	OK	OK	NG	NG	NG
	4μs	OK	OK	OK	NG	NG	NG	NG	NG	NG	NG	NG	NG
	2μs	OK	NG	NG	NG	NG	NG	NG	NG	NG	NG	NG	NG

OK: Settable, NG: Not settable

***11. Multi Recorder
– Separately Executing
Waveform Printing, Memory
Recording and HD
Recording***

11.1. Overview of Multi Recorder Mode

Multi Recorder enables operations of Memory Recorder, HD Recorder, and waveform printing at the same time. This Recorder is suitable to the measurement such that data before or after the trigger is precisely recorded while long-time recording is made.

The waveforms of recorded data file are displayed on the replay monitor screen. Data format in multi data mode is "FPP". With the event jump function of replay monitor, switching between HD recording data and memory recording data can be switched to confirm the data being recorded. For the event jump function, see 14. Replay Display.

In order to set the recorder to the Multi-Recorder mode, use the Measurement Mode tab in the System screen. Besides, setting of measurement mode can be made in the Startup screen displayed upon the recorder startup. (* The Startup screen may not be displayed depending on the settings.)

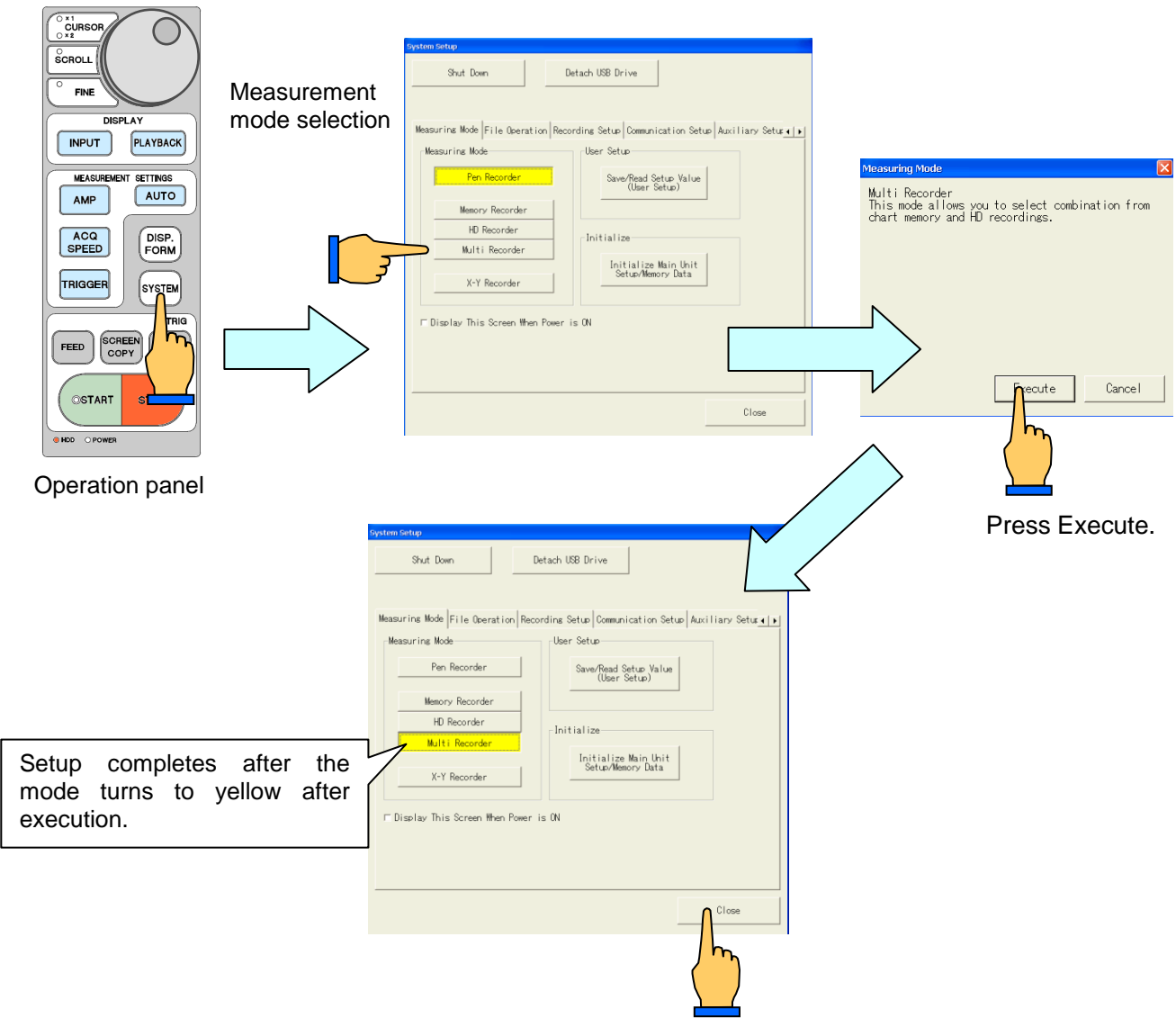

11.2. Recording Condition Setup

Open the following screen by pressing the Recording Condition button on the Operation Panel to set the recording conditions for HD Recorder. The recording condition setup should be made while the recorder stops its operation. Setup can be made during recording.

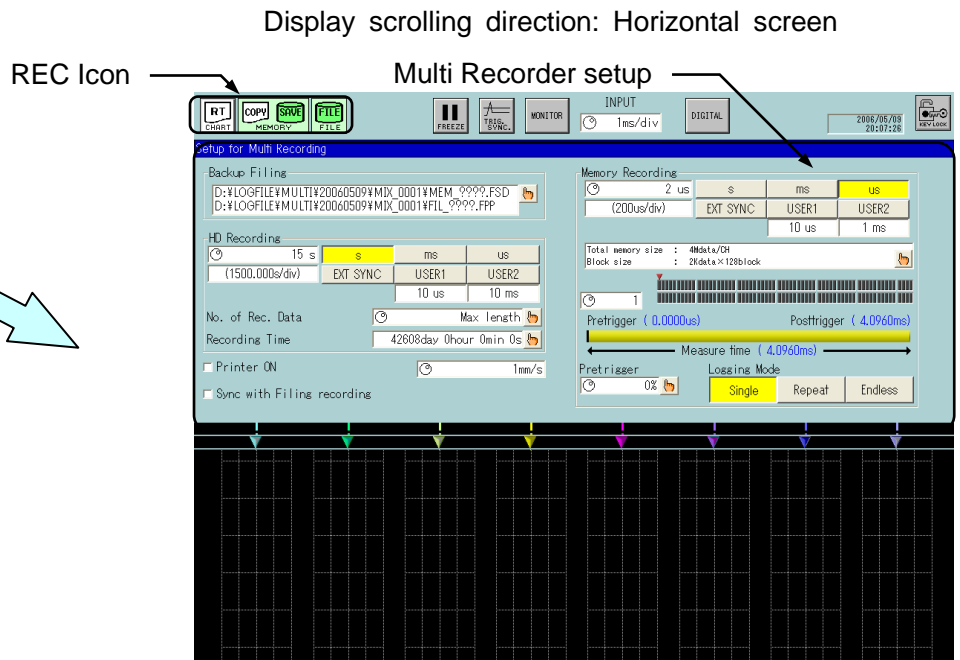
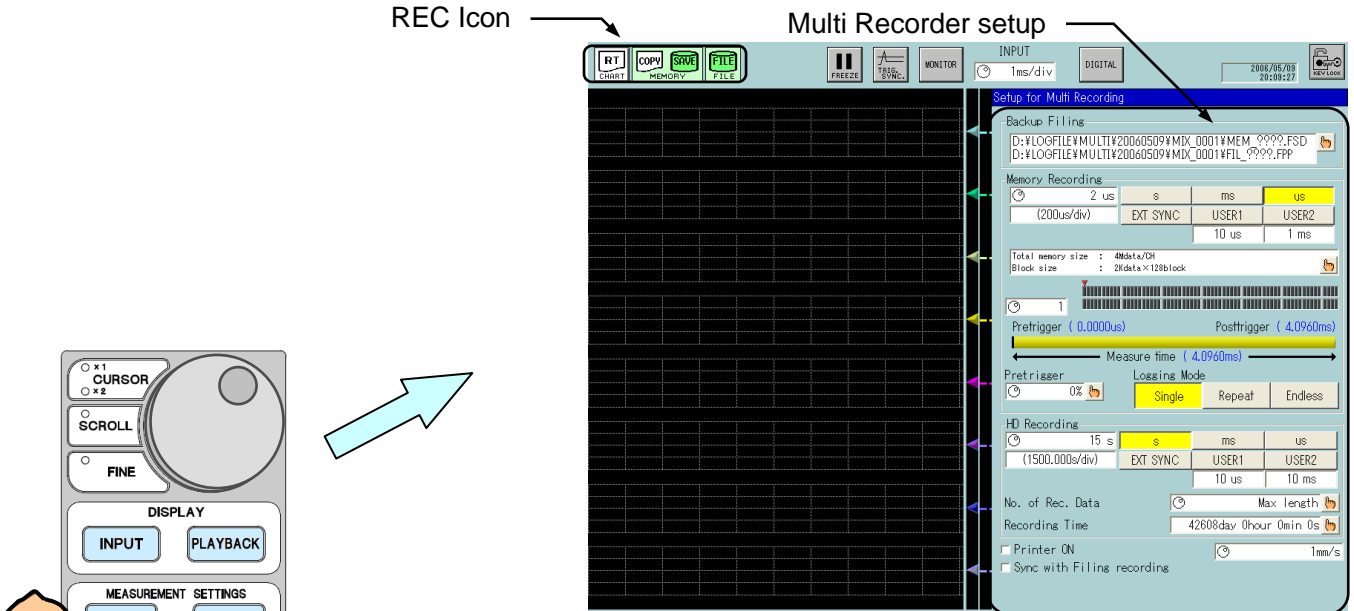

11.2.1. REC Icon

The icons signify recording status.

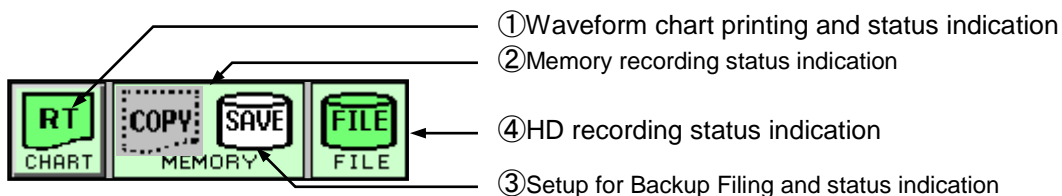

	① Chart Printing	② Memory Recording	③ Backup Filing	④ HD Recording	⑤ Others
Stop OFF (White)		NA			Auto copy does not operate. Icons are invalid.
Stop ON (Green)					
Measuring (Amber)				↔	
Error (Red)					

* Pressing chart printing button can switch ON/OFF for chart printing while recording.

11.2.2. Multi Recorder - Setup for Recording Condition

Setup for Multi Recording

(1) Backup Filing
 D:\LOGFILE\MULTI\20050901\MIX_0001\MEM_????.FSD
 D:\LOGFILE\MULTI\20050901\MIX_0001\FIL_????.FPP

(2) Memory Recording
 10 us s ms us
 (1.000ms/div) EXT SYNC USER1 USER2
 10 us 1 ms
 Total memory size : 8Mdata/CH
 Block size : 2Kdata×128block
 1
 Pretrigger (10.240ms) Posttrigger (10.240ms)
 Measure time (20.480ms)
 Pretrigger 50% Logging Mode Single Repeat Endless

(3) HD Recording
 1 s s ms us
 (100.000s/div) EXT SYNC USER1 USER2
 10 us 10 ms
 No. of Rec. Data Max length
 Recording Time 2439day 12hour 0min 55s

(4) Printer ON 1mm/s
 Sync with Filing recording

Display scrolling direction: Horizontal screen

- (1) File output path
- (2) Memory recording setup block
The setup steps are the same as in 9. Memory Recorder.
- (3) HD recording setup block
The setup steps are the same as in 10. HD Recorder.
- (4) Waveform recording

Display scrolling direction: Vertical screen

Setup for Multi Recording

(1) Backup Filing
 D:\LOGFILE\MULTI\20060509\MIX_0001\MEM_????.FSD
 D:\LOGFILE\MULTI\20060509\MIX_0001\FIL_????.FPP

(2) Memory Recording
 2 us s ms us
 (200us/div) EXT SYNC USER1 USER2
 10 us 1 ms
 Total memory size : 4Mdata/CH
 Block size : 2Kdata×128block
 1
 Pretrigger (0.0000us) Posttrigger (4.0960ms)
 Measure time (4.0960ms)
 Pretrigger 0% Logging Mode Single Repeat Endless

(3) HD Recording
 15 s s ms us
 (1500.000s/div) EXT SYNC USER1 USER2
 10 us 10 ms
 No. of Rec. Data Max length
 Recording Time 42608day 0hour 0min 0s

(4) Printer ON 1mm/s
 Sync with Filing recording

NOTE

Setting procedure in the screen above is the same as that in 9. Memory Recorder. However, the following settings are not available due to the recorder mode difference.

- Data output related settings

NOTE

Setting procedure in the screen above is the same as that in 10. HD Recorder. However, the following settings are not available due to the recorder mode difference.

- Recording procedure is to use "Start" key only and for the point of trigger detection there is not setting for "Once" or "repeat" setting.
- Data format is only for peak

① File save

The path for file save can be specified. Pressing the key opens the following dialog box.

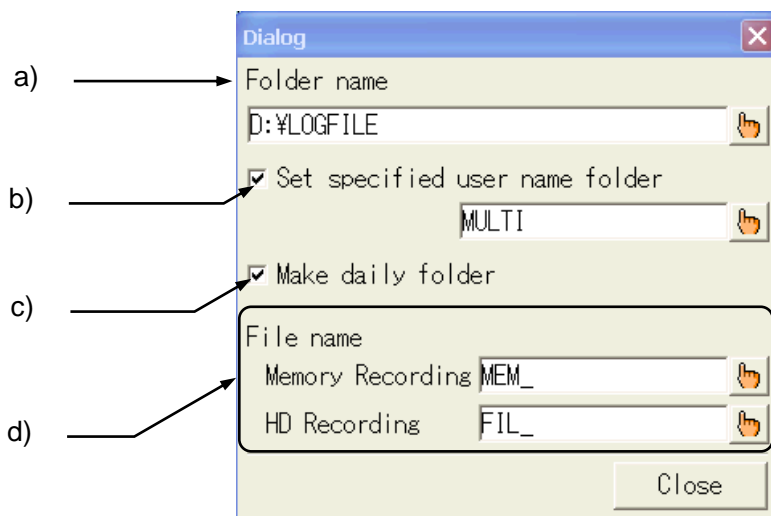

- a) **Path for file save**
Specify the path for file save. You can choose a USB storage drive other than internal HDD.
- b) **ON/OFF for user-specified folder**
Setting to ON creates a folder that are specified by user. The place under this folder becomes the place for file save.
- c) **ON/OFF for folder by day**
Pressing ON creates the file by day referencing the starting time. The place under this folder becomes the place for file save.
- d) **Arbitrary file name (Top four letters)**
An individual file name can be set in memory recording and file recording. The file name consists of eight letters: specified four letters for the first half and automatically assigned four letters for the latter half. File extension "FSD" is for memory recording, while "FPP"(binary save) is for file recording.

② Memory recoding setup block

Settings for memory recording can be made.

③ HD recording setup block

Settings for HD recording can be made.

④ Waveform chart recording

Settings for waveform chart printing can be made.

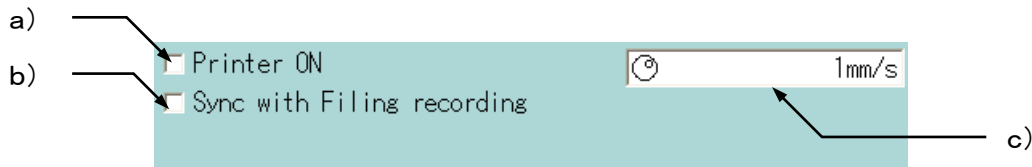

a) ON/OFF for printing

ON/OFF for waveform chart printing can be set.

b) Operations synchronized to recording speed

Ticking the checkbox permits a synchronized operation between waveform chart printing speed and recording speed. To maintain both recording speed and chart printing speed, remove the tick.

NOTE The fastest chart feed speed is 50 mm/s. If the value equivalent to recording speed exceeds this value, printing with fastest speed will be made.

c) Chart feed speed setup

Setting of the chart feed speed that is separated from the recording speed can be made.

11.3. Recording Operation

The multi-recording begins when the Start button on the Operation Panel is pressed. Recording set through waveform printing, Memory Recording, or HD Recording can be made simultaneously.

For memory recording, see 9. Memory Recorder. For HD recording, see 10. HD Recorder.

11.3.1. Error Generation

Error that may occur during multi recording and operations are described as follows.

Error	Operation
File error	HD recording will stop with an error. If waveform chart printing and memory recording or memory recording are operating, the operation continues.
Paper-out error	Memory recording and HD recording continues. The waveform chart printing will stop with an error. After the chart paper is filled, recording resumes.

12. X-Y Recorder

12.1. Overview of X-Y Recorder Mode

The X-Y Recorder mode is a mode that is specialized to real-time X-Y printing, which outputs X-Y waveforms on chart paper. Data sample speed and amp settings are available on a screen.

To set the recorder to the X-Y recorder mode, use the Measurement Mode tab on the System screen. In addition, the measurement mode settings can be made on the Startup screen that is displayed when the recorder is started up. (* The Startup screen may not be displayed depending on the settings.)

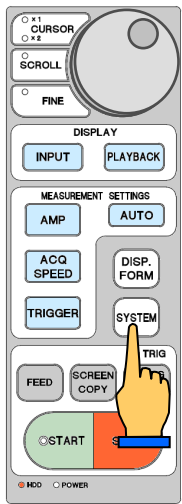

Operation Panel

Measurement mode selection

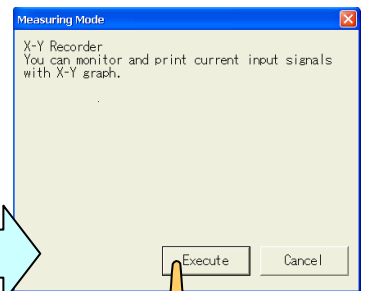
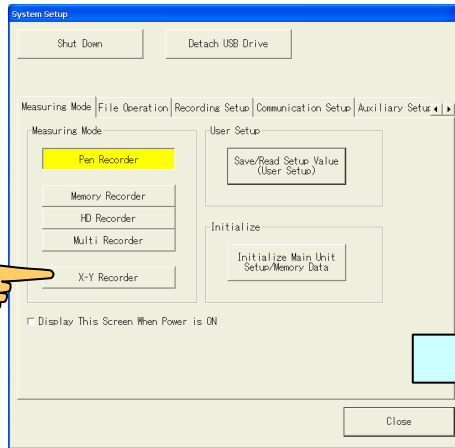

Press Execute.

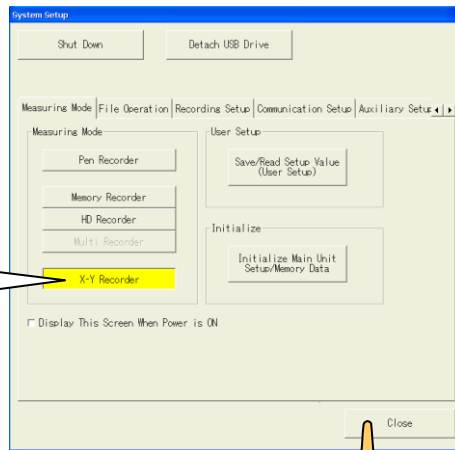

Setup completes after the mode turns to yellow after execution

Pressing Close closes the Setup screen. The mode setting completes after the screen is switched.

NOTE

Since the X-Y Recorder is a mode that is specialized to the X-Y printing, the same screen is displayed even screen buttons of Input Signal, Amp, Recording Condition, and Trigger.

12.2. Screen Operation

Press any button among Input Signal, Amp, Recording Condition, and Trigger buttons. The following screen appears.

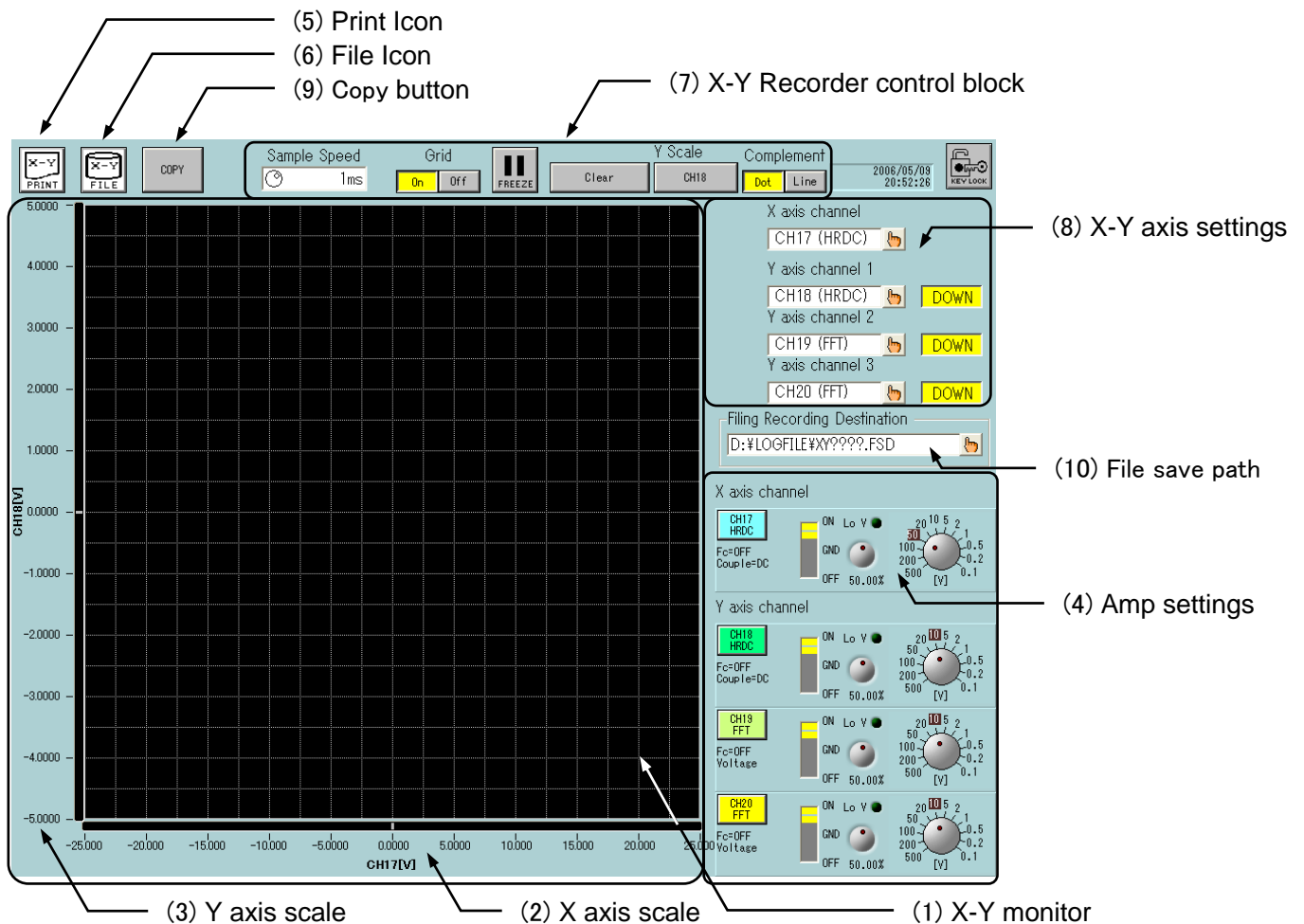

(1) X-Y monitor

X-Y display for input signals is made.

signifies current input signal position (hereafter called “pen mark.”)

(2) X-axis scale

Measurement scale specified to the X axis is displayed.

(3) Y-axis scale



Only one measurement scale specified to the Y axis is displayed. The scale to be displayed can be changed using Y scale button.

(4) Amp setup

The setup for the channel specified to X and Y axes can be made. For how to use amp units, see 7. Amp Unit.





(5) Print Icon

Pressing this icon button sets printout ON or OFF for the X-Y recording. The following table illustrates the X-Y printing status during X-Y recording.

Normal	To execute	Error
		

(6) File Icon

Pressing this icon button sets file recording to ON or OFF. Setting to ON saves data of X-Y recording in internal HDD file. The data saved can be displayed in the X-Y graph on the replay monitor. Moreover, operating status is indicated during X-Y recording. The File icons that appear are as follows.

ON	OFF	To execute	Error
		 	

NOTE

File save destination during X-Y recording is a folder in the internal HDD.

(7) X-Y Recorder Control Block

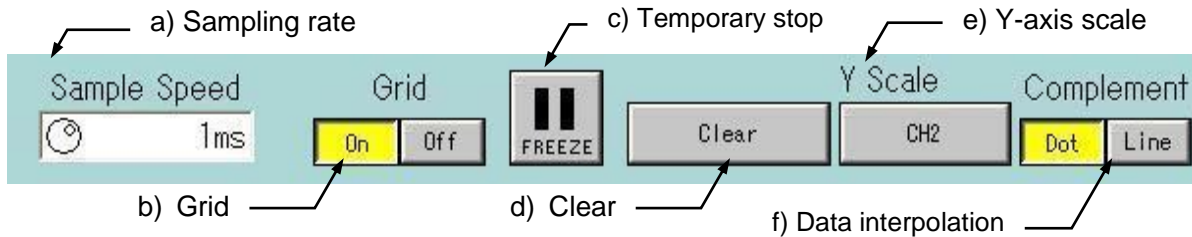

- a) **Sampling rate**
This button is used to set data sampling rate for X-Y recording.
- b) **Grid**
This button is used to set grid to ON or OFF in the X-Y monitoring and X-Y printing. For grid pattern for the X-Y printing, see 16. System Setup.
- c) **Temporary stop**
The X-Y monitoring can be stopped temporarily. Pressing this button again cancel this temporarily stop.
- d) **Clear**
This button is used to clear the waveforms on the X-Y monitor.
- e) **Y-axis scale**
This button is used to switch the Y-axis scale representation.
- f) **Data interpolation**
X-Y waveform data interpolation can be set.

(8) XY-axis setting

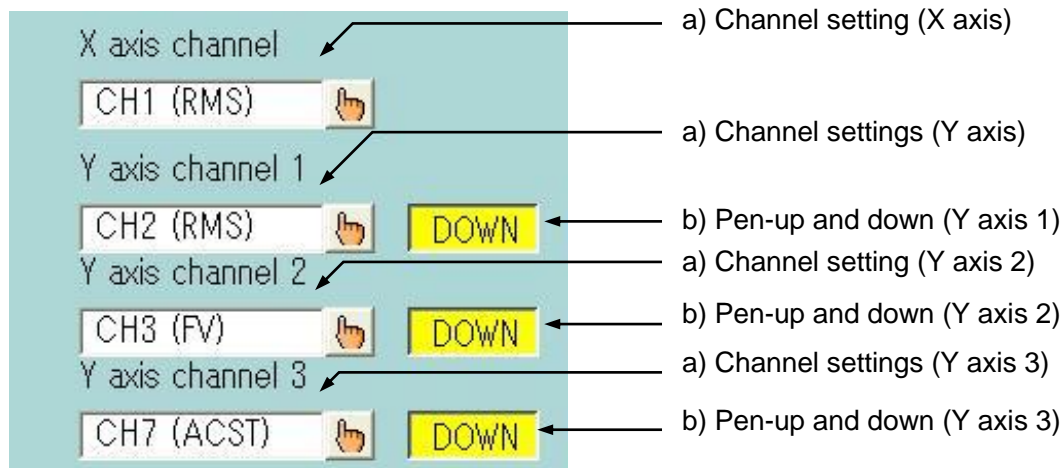

a) Channel settings

One channel for X axis and three channels for Y axes can be made. The amp types that can be registered are only analog amps.

b) Pen-up and down

X-Y waveform display ON or OFF can be set for three Y-axis channels. Pen-down draws waveforms; Pen-up does not draw waveforms. Pen mark always appears regardless of the up/down setting. However, the pen mark appears on the X-Y monitor only and does not appear on the X-Y printing.

NOTE

In the case of X-Y mode, printing line width is constant as 0.125mm.

(9) Copy button

When the button of copy is ticked, data is printed out on chart paper.

(10) File save path

Save target path for XY recording is indicated. Pressing the button opens the dialog box and the path can be set.

a) Save target folder

The save target folder is specified.

Both embedded HDD and recommended USB device can be used as storage devices

b) User name entry folder

When this box is ticked, a folder is created and the save target will become inside of this folder

c) Make daily folder

When this box is ticked, a daily folder is made, and data is saved in the folder.

d) File name(Only first 4 characters)

Only first 4 characters can be specified as file name. File name consists of the first 4 characters, and second 4 characters that are automatically assigned number. The file name will include designated top four letters and four-digit serial number. The file extension is "FSD" for binary file respectively.

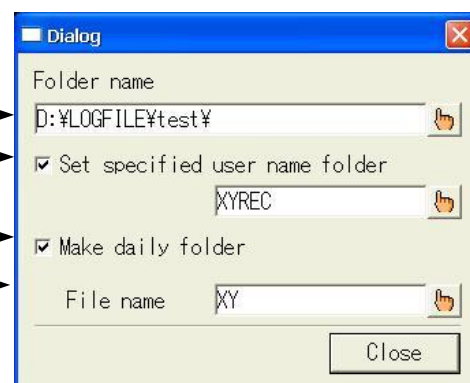

12.3. Printing Operation

Pressing the Start button on the operation panel clears X-Y data display from the X-Y monitor and, shortly after that, re-displays the X-Y data display again. Pressing the Stop button stops the X-Y monitor and if the printout is set to valid, prints the X-Y waveforms on chart paper. If the file saving is set to be valid during this period, recording data can be saved in a file.

NOTE

Pressing the Stop buttons two times cancels the output to chart paper. Avoid pressing the button more than two times.

12.3.1. Restrictions during X-Y Printing

There are following restrictions in X-Y printing.

- **Setup changes cannot be made.**
- **X-Y monitor clear and stop cannot be made.**
- **Screen movement cannot be made.**

Press the STOP button and finish the X-Y printing to execute the operations above.

12.3.2. Exception (Error)

An error may be generated during X-Y printing due to the following reasons.

- **Paper-out**

This error is generated when the chart paper is run out. Fill in a chart recording paper.

NOTE

After X-Y printing, the monitor stops display temporarily. After filling a chart recording paper, pressing the Print icon button performs the display same as the X-Y printing.

- **File error**

This error occurs when file recording cannot be made due to internal HDD free space shortage or other causes. After reducing data in the internal HDD, execute recording. Even a file error occurs, the X-Y printing continues.

13. Trigger Settings Capturing Target Data to be Recorded

13.1. Trigger Mode Description

This recorder provides with four trigger modes: OR, AND, WINDOW, and OFF. Other than these modes, there are manual trigger and external triggers, which are valid regardless of the input signal.

13.1.1. Trigger Mode - Operation at OR

A trigger is generated either of two channels that are set for trigger source satisfies the trigger condition. The OR setting for all channels are also available.

Example: Both of slopes for CH1 and CH3 are set to “rising edge.”

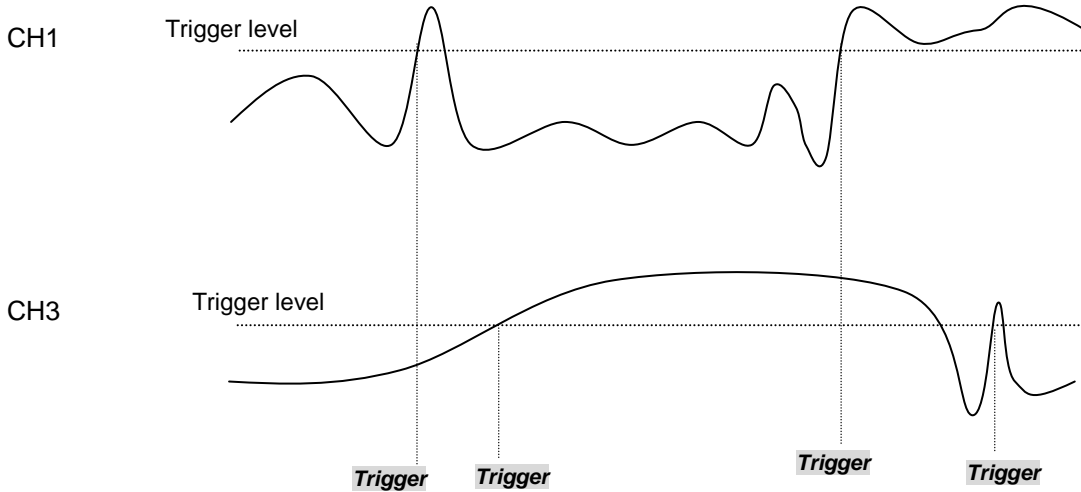

13.1.2. Trigger Mode - Operation at AND

Trigger is generated all channels that are set for trigger source satisfied the trigger condition. The AND setting for all channels are also available.

Example: Both of slopes for CH1 and CH3 are set to “rising edge.”

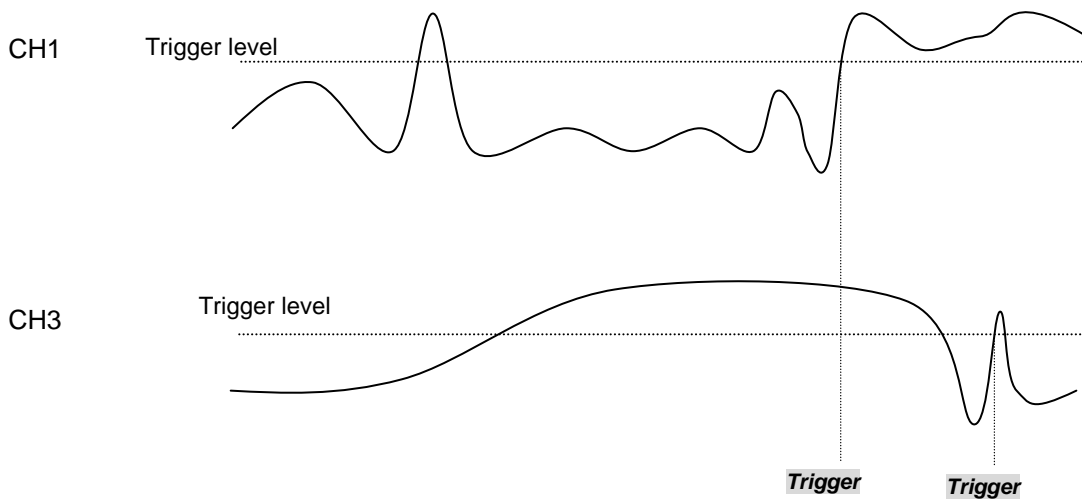

13.1.3. Trigger Mode – Operation at WINDOW

When the signal level enters into the pre-set range of the trigger source channel (i.e. IN) or goes out of the range of the trigger source channel (i.e. OUT), a trigger is generated. The trigger setup can be made for all analog channels. A trigger is generated upon satisfying of either of the trigger settings.

Example: When CH8 is set to OUT

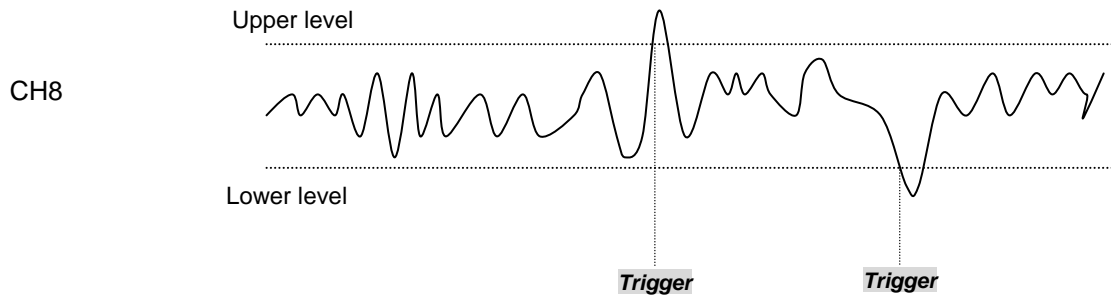

13.1.4. Trigger Mode – Operation at OFF

Trigger caused by a signal input into amp is not made. Only the manual and external triggers are effective.

NOTE

When printing is made, only the trigger made after the startup is effective. If the trigger condition is satisfied before the start of recording, the status enters into the wait for next trigger condition.

13.2. Manual Trigger/External Trigger

Regardless of trigger modes, trigger is activated manually or externally, thereby initiating the recording.

13.2.1. Manual Trigger

Pressing the Manual/Marking button on the operation panel generates a trigger irrespective of other trigger settings.

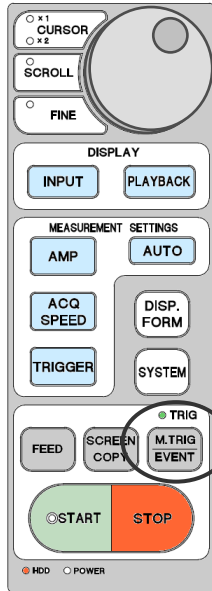

Press Manual Trigger/Marking. A trigger is generated and trigger LED (green) comes on.

13.2.2. External Trigger (TRIG IN)

Trigger is generated by the falling edge of a 0 to 5-V signal. To use, enter a signal into TRIG IN in the re

TRIG IN TRIG OUT



13.2.3. External Trigger Output (TRIG OUT)

When a trigger is generated, the L level of the signal, which has TTL level and approximate 10-ms pulse width, is output from the TRIG OUT terminal.

13.2.4. External Trigger Input/Output Circuit

- **External trigger input circuit**
Input signal: 0 to 5-V voltage signal (falling edge)

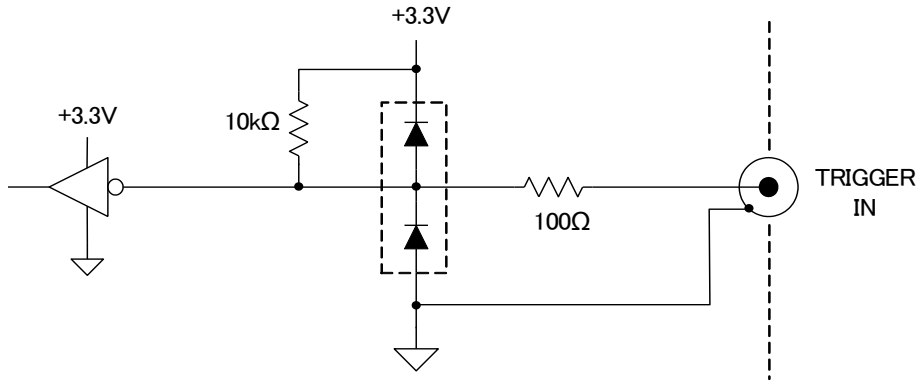

- **External trigger output circuit**
Output signal: TTL level active LOW
Pulse width: Approx. 10 ms

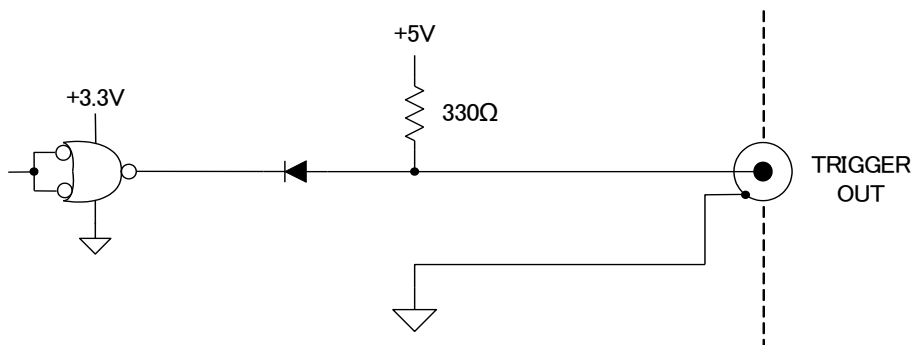

13.3. Method of Trigger Settings

Trigger is a timing signal to start recording. The RA2800A has a variety of trigger function, thus enabling efficient data recording and printing. Pressing the Trigger button on the Operation Panel, opens the Trigger Settings screen.

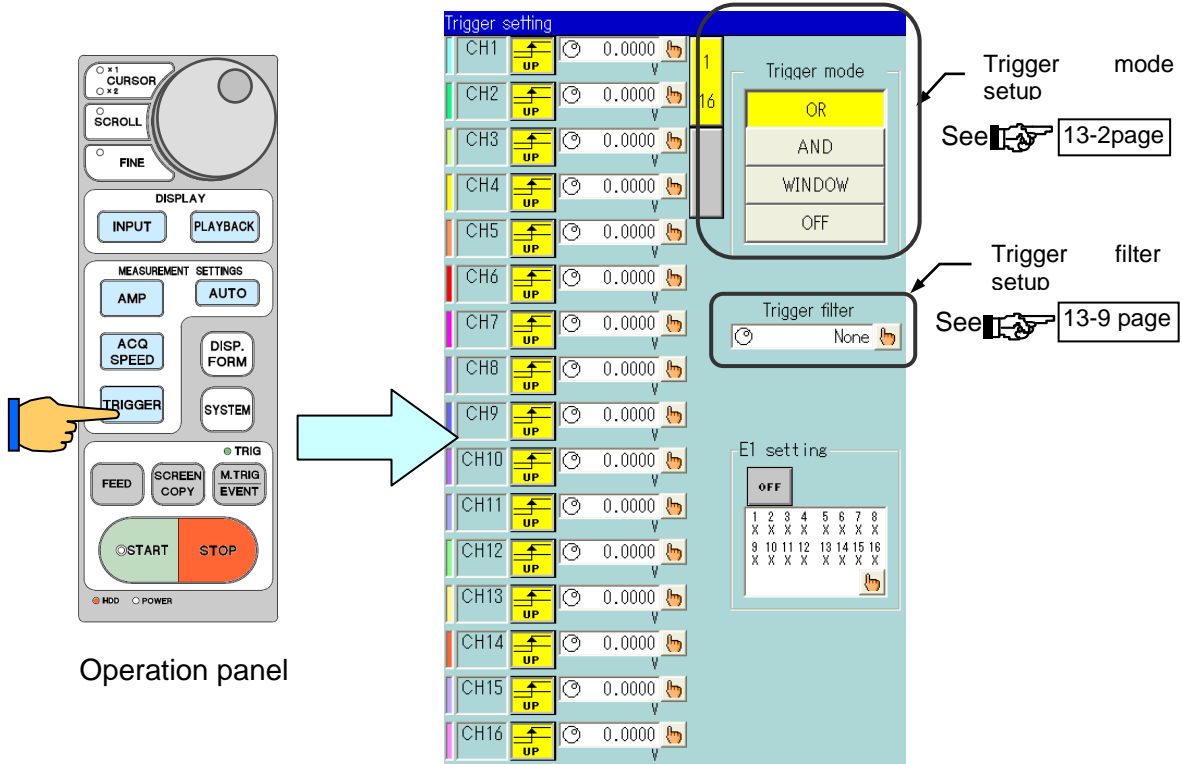

Operation panel

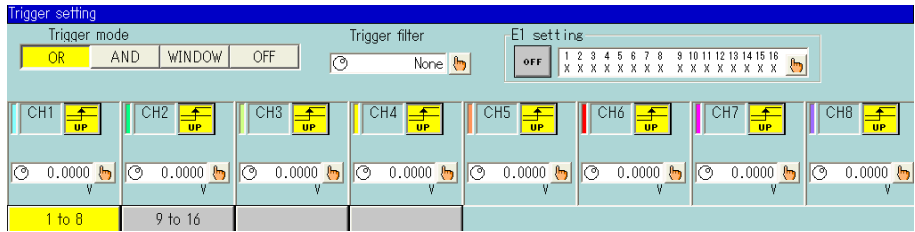

Trigger settings screen

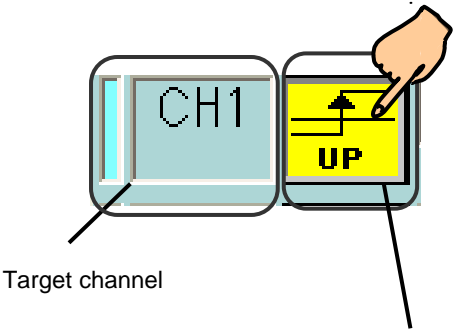

Target channel

- Pressing this portion switches the slope.
- Trigger detection at rising edge of a signal.
 - Trigger detection at falling edge of a signal
 - OFF

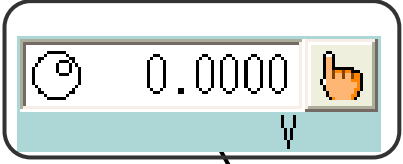

The color of this portion changes its color by touching. Then, signal level can be set by dialing the jog dial

13.4. Settings by Trigger Mode

13.4.1. Trigger Mode OR

Trigger is generated upon the satisfaction of either of the trigger conditions set as the trigger source. The OR setting for all channels are available.

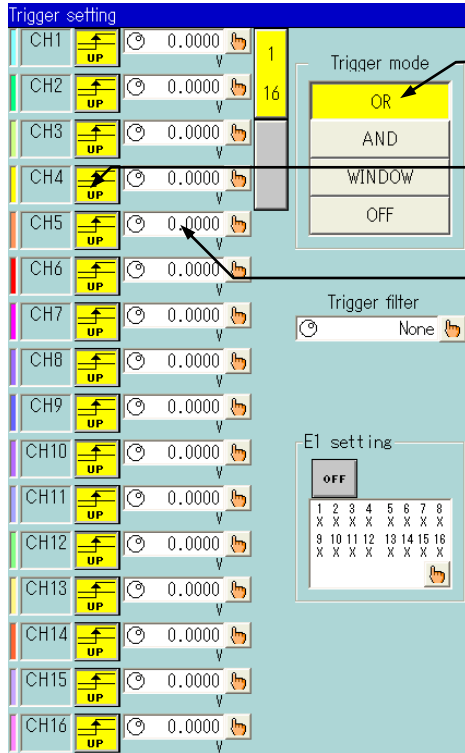

Setting the trigger mode to OR.

Selection of the trigger source channels to be set and settings of rising or falling edge for the signal is made.

Setting the trigger generation level

* Even if the screen scrolling is set to the vertical direction, all operations and functions are the same.

13.4.2. Trigger Mode AND

Trigger is generated upon the satisfaction of the trigger condition for all channels that are set as the trigger source.

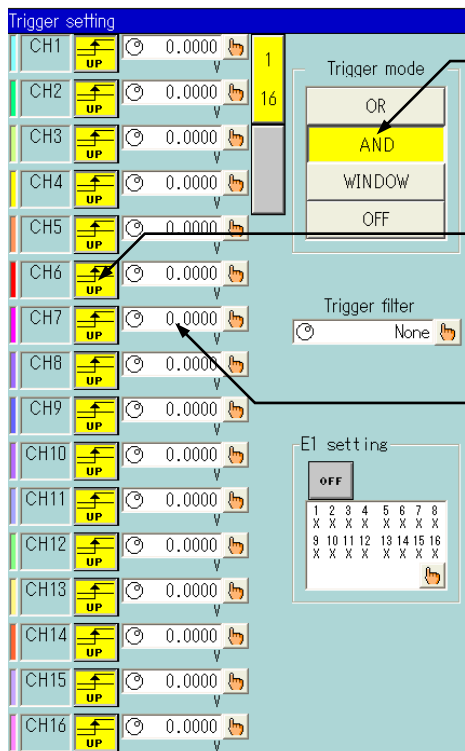

Setting the trigger mode to AND.

Selection of the trigger source channels to be set and settings of rising or falling edge for the signal is made.

Setting the trigger generation level

* Even if the screen scrolling is set to the vertical direction, all operations and functions are the same.

13.4.3. Trigger Mode WINDOW

When the signal level enters into the pre-set range of the trigger source channel (i.e. IN) or goes out of the range of the trigger source channel (i.e. OUT), a trigger is generated. The trigger setup can be made for all analog channels. A trigger is generated upon satisfying of either of the trigger settings.

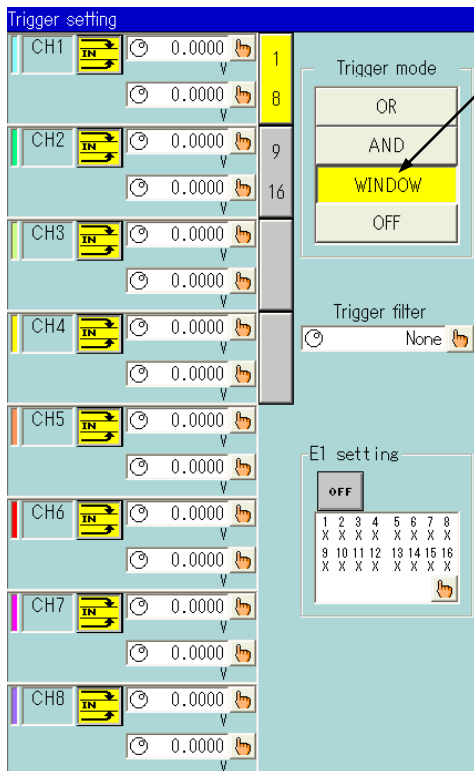

Setting the trigger mode to WINDOW

* Even if the screen scrolling is set to the vertical direction, all operations and functions are the same.

13.4.4. Trigger Mode OFF

Trigger caused by a signal input into amp is not made. Only the manual and external triggers are effective.



Setting the trigger mode to OFF

* Even if the screen scrolling is set to the vertical direction, all operations and functions are the same.

NOTE

When printing is made, only the trigger made after the startup is effective. If the trigger condition is satisfied before the start of recording, the status enters into the wait for next trigger condition.

13.5. Trigger Filter

13.5.1. *Trigger Filter*

After the trigger condition that is set is satisfied, the trigger is activated after this satisfied condition continues for a specified period of time. This function is effective to eliminate noises whose pulse length is relatively short.

NOTE

For a peak recording in HD recorder mode, please calculate based on Recording Sampling Rate = 2 μ s.



13.6. Trigger Settings for Event Amp

Trigger settings for event amp differs from those of other amps. The settings are made in the following screen.

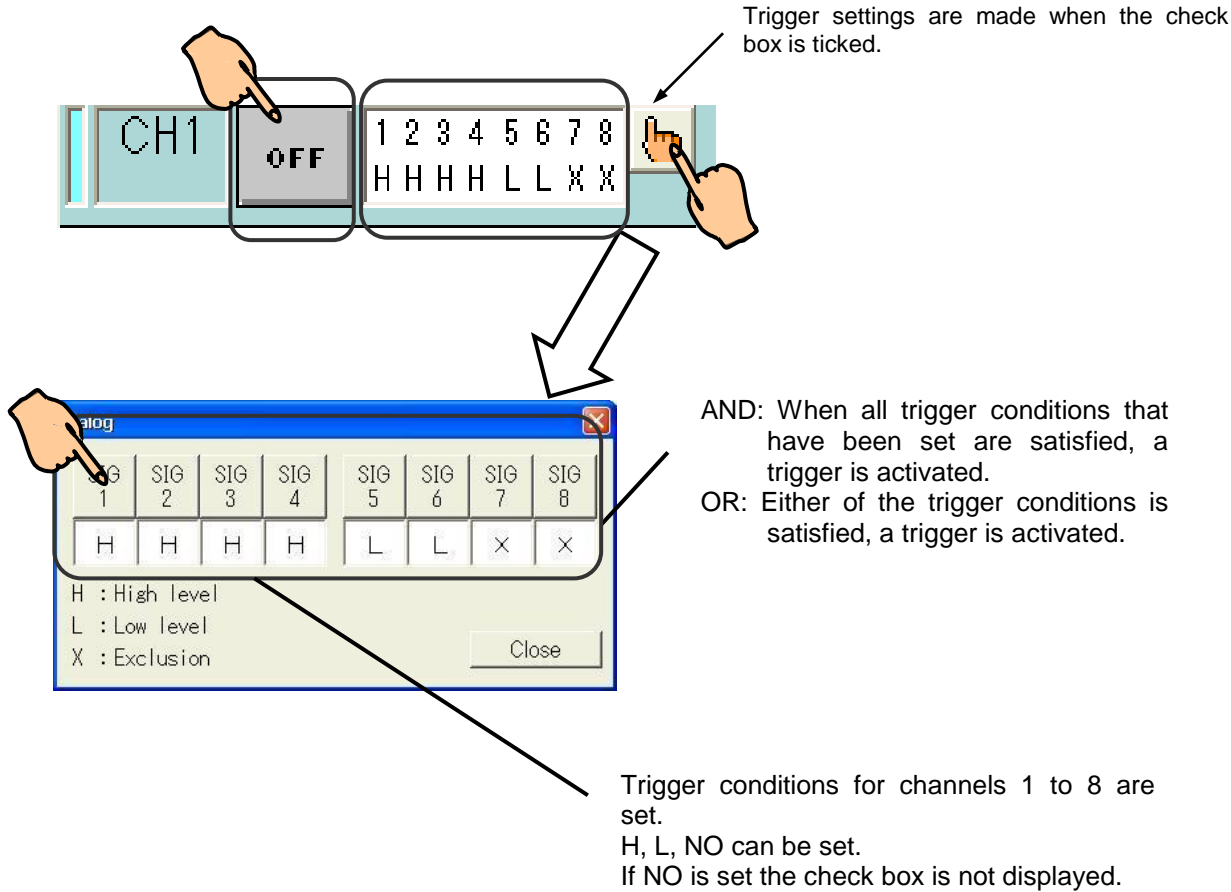

● **Trigger condition settings**

Trigger condition	Volt (Voltage input)
H	The H condition is satisfied when the input voltage reaches +2.5V or higher.
L	The L condition is satisfied when the input voltage becomes +0.5 V or lower.
NO	Exempting from trigger conditions

NOTE

In the event amp, a trigger is activated when first trigger condition is satisfied. If the trigger condition has been satisfied, a trigger will be not be activated. Especially, for example, one channel has already been satisfying the trigger condition in the OR mode, the trigger will be activated even when other channel's trigger condition is satisfied.

13.7. Trigger Settings for Event unit

When using the recorder event, please use the (RT31-163) or (0311-5001) input cable for event of cables described in the chapter 21 Cables and Probes.

Select a trigger condition from OR, AND, or OFF for setup.

The setting of each channel is displayed.

Open the window to set trigger conditions of signals 1 to 16. Select an option from H, L, or X for setup.

SIG	SIG	SIG	SIG	SIG	SIG	SIG	SIG
1	2	3	4	5	6	7	8
H	L	H	H	H	H	H	H
SIG	SIG	SIG	SIG	SIG	SIG	SIG	SIG
9	10	11	12	13	14	15	16
X	X	X	X	X	X	X	X

H : High level
L : Low level
X : Exclusion

Trigger condition	Voltage input
H	The H condition is established when the input voltage is approximately +2.5V or more.
L	The L condition is established when the input voltage is approximately +0.5V or less.
X	The signal is excluded from a trigger condition.
Trigger condition	Contact input
H	The H condition is established while the input is in the OPEN state.
L	The L condition is established when the input is in the CLOSE state.
X	The signal is excluded from a trigger condition.

NOTE The VOLTAGE and CONTACT events are selected by the MODE slide switch on the back side of the recorder.

14. Replay Display Displaying Recording Data

14.1. Overview of Replay Monitor

The Replay screen is used to display the data recorded in memory or file. Waveform display for recorded data is available after the data is selected in the list.

The screenshot shows the RA2800A Recorder's Replay Monitor interface. The main display is divided into several sections:

- Top Panel:** Includes 'Select Data' (1), 'Output Setting' (2), 'コピー' (3), 'Digital Display' (4), 'Signal Setting' (5), 'Jump' (6), a scale indicator 'x 1' (7), and a timestamp '2/22 19:44:38' (8).
- Waveform Area:** Displays multiple colored waveforms (10) for various channels. A table of signal data is shown to the right of the waveforms, with columns for channel names (e.g., SIG01, SIG17) and numerical values (11).
- Cursor and Measurement Area:** Shows 'Cursor X1' (12) and 'Cursor X2' (13) with their respective time values. A section labeled 'ΔT Between Cursors' (14) displays the time difference between the cursors.
- Control Panel Inset:** Located on the left, it features a 'CURSOR' section with 'x1' and 'x2' indicators, a 'SCROLL' button, and a 'FINISH' button. Below these are 'INPUT' and 'PLAYBACK' buttons. The 'MEASUREMENT SETTINGS' section includes 'AMP', 'ACQ SPEED', 'TRIGGER', 'AUTO', 'DISP. FORM', and 'SYSTEM' buttons. The bottom section has 'FEED', 'SCREEN COPY', 'M.TRIG EVENT', and 'TRIG' buttons, along with 'START' and 'STOP' buttons and 'HDD' and 'POWER' indicators.

Numbered callouts (1-15) point to specific elements in the interface, corresponding to the labels in the text above.

- | | | |
|---------------------------|---|-------------------------------------|
| (1) Data Selection | Selects referencing data | 14.2 Replay Data Selection |
| (2) Output Selection | Outputs to chart or file | 14.8 Output Setup |
| (3) Copy | Copy the waveform to chart paper | 14.8 Output Setup |
| (4) Thumbnail | Displays Y-T waveform display area | 14.3 Waveform Display Region |
| (5) Digital Indication | Switches digital indication | 14.4 Digital Indication |
| (6) Signal Setup | Sets each signal channel | 14.5 Signal Settings |
| (7) Jump | Executes time axis jump | 14.6 Jump |
| (8) Time Axis Scaling | Enlarges or compresses time axis | 14.7 Time Axis Magnification |
| (9) X-Y Display | Switches X-Y waveform display | 14.10 X-Y Waveform Display |
| (10) Y-T Display | Switches Y-T waveform display | |
| (11) Position | Indicates zero position for each signal | |
| (12) Scale | Displays scale for amplitude axis | 15. Display and Print |
| (13) Signal Name | Signal name indication | 15. Display and Print |
| (14) Digital Indication | Indicates value at cursor position | 14.4 Digital Indication |
| (15) Cursor position info | Indicates cursor position info | 14.4 Digital Indication |

TIPS

Display can be set to OFF for scale, signal name, digital indication, and cursor position info. To keep the waveform display area as large as possible, set these settings to OFF. For more information, see 15. Display and Printing.

14.2. Replay Data Selection

To select the screen to be displayed on the Replay monitor, open the following screen by pressing the Data Selection button.

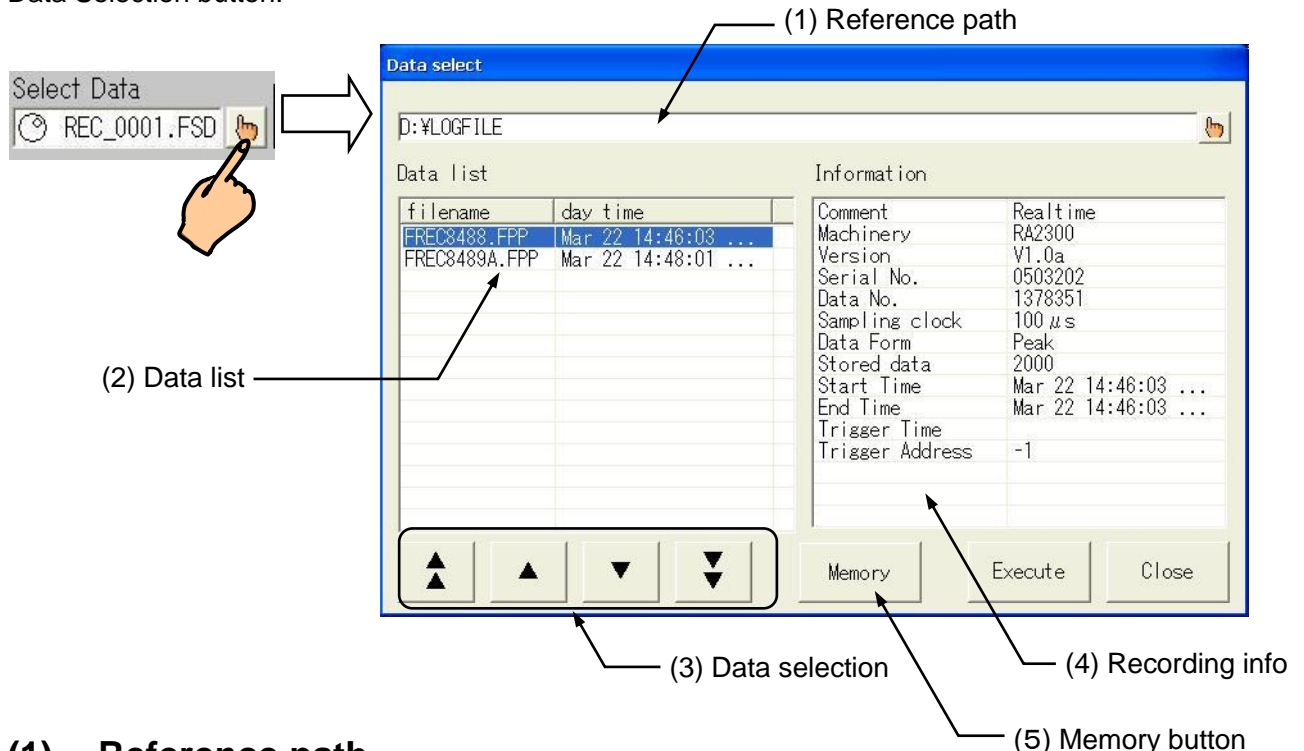

- (1) Reference path**
This indicates data reference target path. Moreover, it is possible to change the path with the dialog box opened by
- (2) Data list sorting**
Sorting by file names or data can be made. Pressing once sorts data in ascending order: pressing again a again sorts data descending order.
- (3) Data selection**
This changes selected data file.

(4) Recording information

This portion lists the information of recorded data that is selected in the data list. This information may be used as a reference for data selection.

TIPS

Trigger address value

Some pre-trigger values are displayed on recording data after trigger recording. However, “-1” is displayed in the case of forced termination of recording.

(5) Memory button

The “Memory” block is used to change into “memory data selection mode”.

It is possible to change into “file data selection mode”, with pushing this block again,

14.3. Waveform Display Region

The thumbnail that indicates waveform display region is displayed on the Replay Monitor screen and the Y-T waveform.

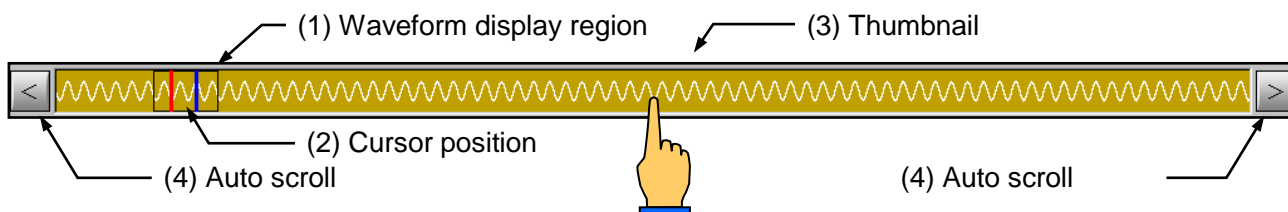

(1) Waveform Display Region

This is the time axis domain currently being displayed.

(2) Cursor position

Cursor positions X1 and X2 are indicated.

(3) Thumbnail

Full data for a channel is displayed in a compressed form. Also, touching the thumbnail portion can move the display position of the Y-T waveform.

TIPS

Channel that can be displayed on the thumbnail can be specified. For more information, see 15. Display and Printing.

(4) Auto scroll

The displayed region can be scrolled automatically. By touching a thumbnail display portion, auto-scrolling stops.

14.3.1. Shift of Waveform Display Region

To shift the waveform display region, refer to the following methods.

- **Operation with thumbnail**

By touching the thumbnail display portion, the waveform display region can be shifted. The auto-scroll buttons at both sides allows one-direction scrolling.

- **Shift through operation panel**

Press the Scroll button on the operation panel to make scrolling effective. When scrolling becomes usable, the LED of the Scroll button comes on. Turning the job dial shifts the display region.

- **Shift through jump faction**

Jump to the trigger detection point or making point is available. Moreover, jump to the maximum or minimum point for each channel is available. For more details, see [14.6Jump]

14.3.2. Shift of Cursor Position

To shift the cursor position, refer to the following methods.

- **Shift through operation panel**
Press the Cursor button on the Operation Panel to make the cursor effective. When the cursor becomes usable, the LED of X1 or X2 of the Cursor button comes on. Turning the jog dial can move the cursor. Smaller-step shift is available using the Fine button on the Operation Panel.
- **Shift through screen touch**
Direct cursor shift is possible by touching the waveform display portion when the cursor shift is effective on the Operation Panel.

14.4. Digital Indication

Indications for digital values and cursor position information for measurement values can be made.

14.4.1. Digital Indication

Measurement values are indicated in digital values. Time-axis position to be displayed changes depending on the LED status.

- **X1 LED On**
Measurement values of the cursor 1 position are indicated while cursor X1 is moving.
- **X2 LED On**
Measurement values for cursor 2 are indicated while cursor X2 is moving.
- **Others**
Measurement values at the top of the waveform display region are displayed during the time excepting when the cursor is moving as well as when waveform display position is moving.



TIPS

If the recording data is the peak format, one data consists of two values: maximum and minimum value. To specify the digital value in either of maximum and minimum values, open the Display/Printing screen. For more details, see 15. Display and Printing.

14.4.2. Cursor Display Information

This portion indicates the position information of cursors X1 and X2 and the time difference between cursors (ΔT).

Time axis display format changes to Duration, Time, and Value in this order with depending on the setting. For more details, see 15. Display and Printing.

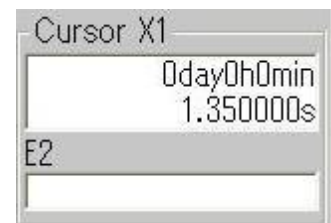

14.4.3. Digital Indication Switching

Pressing the Digital Indication button on the upper part of the Replay monitor, contents of indication can be switched.



The indication changes to No Indication, Digital Value, Cursor Value, Digital Value + Cursor Value, and No Indication, in this order.

TIPS

Digital indication switching can be set in the Display and Printing screen. For more details, see 15. Display and Printing.

14.5. Signal Settings

It is possible to confirm the recording conditions for channel of the signal that are recorded as data and change the setup for waveform display. Press the Signal Setting button on the upper part of the Replay screen. The Setup Screen appears. The contents differ depending on the amp type.

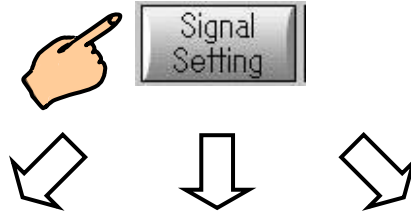

Setup Signal

CH1 EV CH3 HRDC CH5 CH7 HSDC CH9 ACST CH11 HSDC CH13 DCST CH15 TDC

CH2 CH4 HRDC CH6 CH8 HSDC CH10 ACST CH12 HSDC CH14 DCST CH16 TDC Extra Event

ON OFF Bundle

1234 5678
Signal Type: WWV WWV

Event Waveform Printing: ON/OFF

1 2 3 4 5 6 7 8 ON OFF

Range of Record/Display

Record Location: 188.5mm

Pitch Between Signal: 2.5mm

Signal Amplitude: 2.0mm

Base Line Width: 0.8mm

Auto Adjust

Close

- Analog amp setup screen**
- Waveform ON/OFF setting
 - Zero position setting
 - Physical unit conversion setting
 - Other recording condition display

Setup Signal

CH1 EV CH3 HRDC CH5 CH7 HSDC CH9 ACST CH11 HSDC CH13 DCST CH15 TDC

CH2 CH4 HRDC CH6 CH8 HSDC CH10 ACST CH12 HSDC CH14 DCST CH16 TDC Extra Event

ON OFF Bundle

Range: 500V
Coupling: DC
Filter: OFF

0 Position: 50.00%

Use Physical Conversion Value

Input: Max 10.000, Min 0.0000, Unit [V]

Output: Max 10.000, Min 0.0000

Range of Record/Display

Max Record/Display: 250.00V

Min Record/Display: -250.00V

Close

- Event amp setup screen**
- Waveform ON/OFF setting
 - ON/OFF setting by signal
 - Event waveform adjustment
 - Signal type display

Setup Signal

CH1 EV CH3 HRDC CH5 CH7 HSDC CH9 ACST CH11 HSDC CH13 DCST CH15 TDC

CH2 CH4 HRDC CH6 CH8 HSDC CH10 ACST CH12 HSDC CH14 DCST CH16 TDC Extra Event

ON OFF Bundle

Event Waveform Printing: ON/OFF

1 2 3 4 5 6 7 8 ON OFF

9 10 11 12 13 14 15 16 ON OFF

Range of Record/Display

Record Location: 48.0mm

Pitch Between Signal: 2.5mm

Signal Amplitude: 2.0mm

Base Line Width: 0.5mm

Auto Adjust

Close

- Recorder event setup screen**
- Waveform ON/OFF setting
 - ON/OFF setting by signal
 - Event waveform adjustment

TIPS

Operations of Signal Setup screen is the same as those of the Amp screen. For more details, see 7. Amp Units

14.6. Jump

Jump of Y-T waveform display position can be made after the time axis position is specified. Pressing the Jump button on the upper part of the Replay screen displays the following screen.

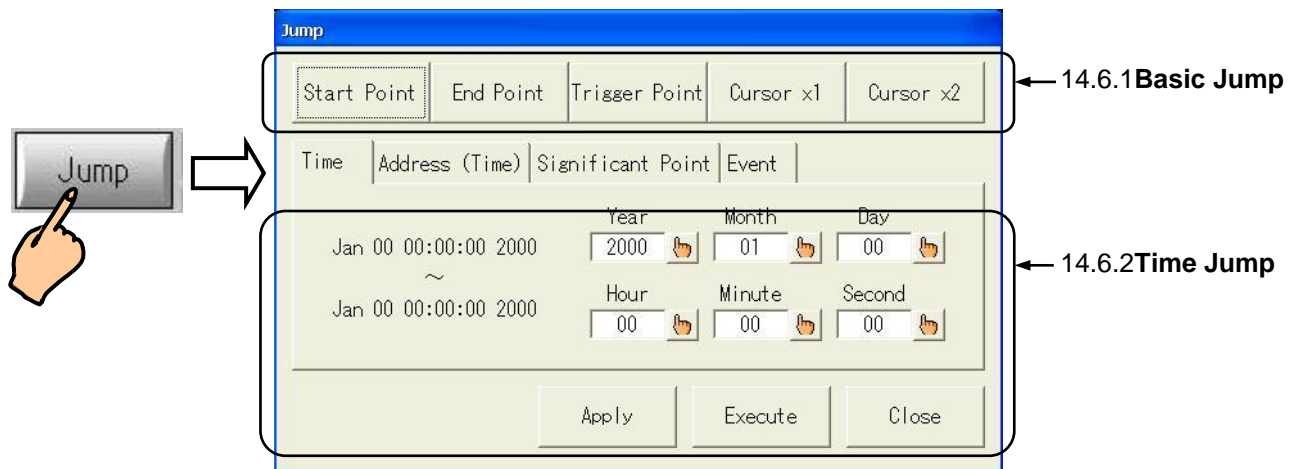

14.6.1. Basic Jump

Basic jump operation is made.

Start point:	Jump to recording data start point
End point:	Jump to the end point of the recording data
Trigger detection point:	Jump to the trigger detection point for recording data
	If there is no trigger detection point, jump is made to the start point.
Cursor X1/X2:	Jump to current cursor position

TIPS

Jump is made when the button is pressed.

14.6.2. Time Jump

Jump is made after the waveform display position is specified. Specify the time using the Time tab on the Jump screen. Pressing the Apply and OK buttons execute a jump.

TIPS

When the Apply button is pressed, the jump screen does not close the Jump screen even after the jump execution. To execute jump continuously, this button is usable.

NOTE

If the recording rate of the recording data is external sync, time jump cannot be made because the time axis cannot represent as time. Use [14.6.3Address Jump]

14.6.3. Address Jump

Jump can be made after waveform position is designated in address. Open the Address tab on the Jump screen, and then specify the address. Press the Apply button and OK button to execute a jump.

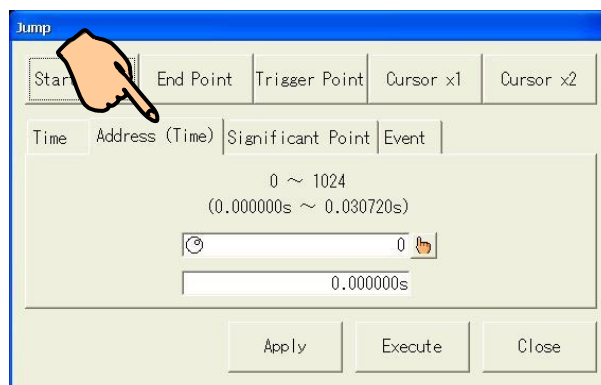

14.6.4. Maximum/Minimum Search & Jump

Searching for maximum and minimum values for all analog channels is available. Jump to the searched position is possible after listing the result.

Operation steps for the maximum and minimum values search are as follows.

- (1) **Use the Max and Min tab on the jump screen.**
- (2) **Specify the search range.**
Choose All or Between Cursors. Press a button begins searching, and after the search, a list appears.
- (3) **Select a channel**
Select a target channel. Selection can be made through a direct touch of listed portion.
- (4) **Jump to maximum value or minimum value is made.**
Pressing a button executes a jump.

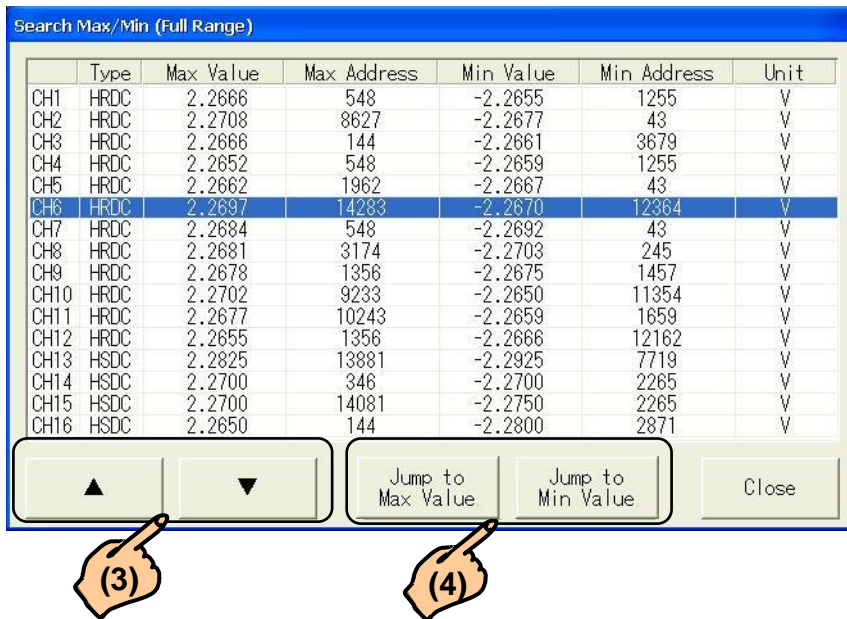
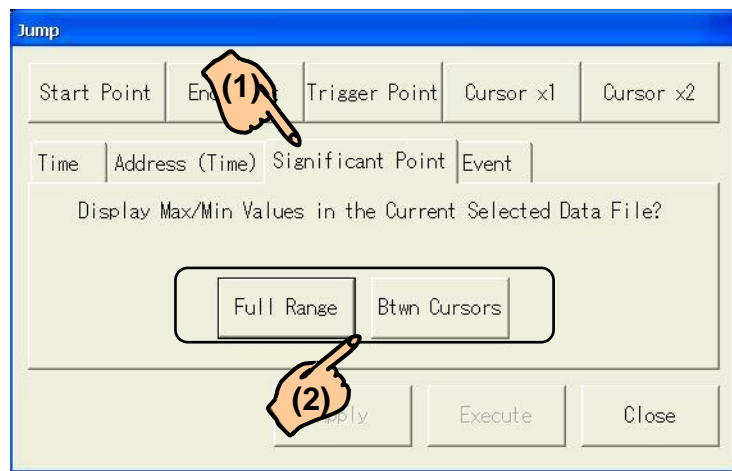

14.6.5. Event Jump

Marking information that is recorded in the recorded data is searched and jump is made.

- (1) The Event tab on the Jump screen is displayed.
- (2) Marking jump is executed when a search direction button is pressed.

NOTE The event jump needs the data which it included E2 in.
 To include E2 in the recording data, the following setting is necessary.

- System- Recording Setup- Recording Channels: E2 ON
- Amp Basics Screen : E2 ON

NOTE Marking jump is a jump to the mark address that is closest to the direction that is specified by jump target address (Waveform, x1, x2). Also, a trigger point is regarded as a mark. If the mark is not found, jump to the start/end point is made.

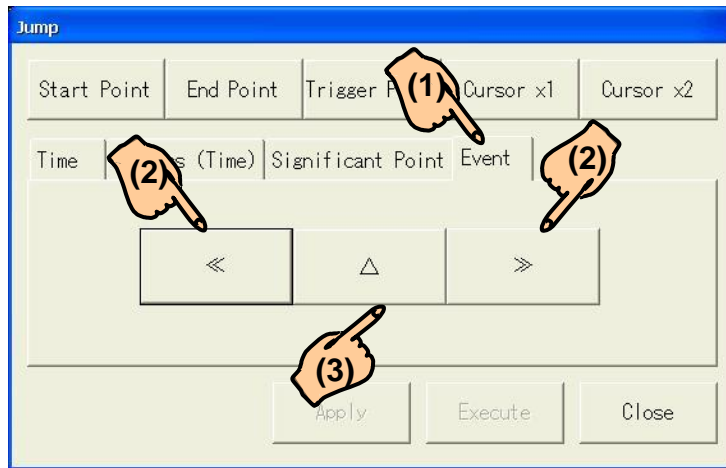

- (3) Jump to link data is made.
 When this button is pressed after the making jump is made while the data file (Extension of FPP) recorded in the Multi Recorder mode is displayed. a jump to the link data (memory recording data) is made.

14.7. Time Axis Magnification

To enlarge or compress the time axis, press [Time Axis] button. The following screen appears.

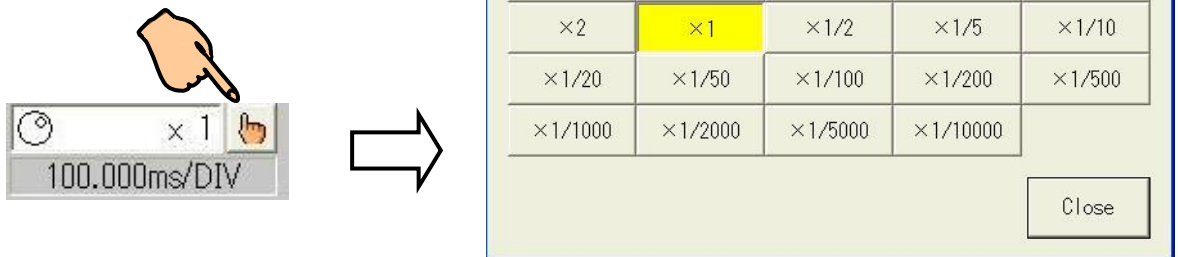

Press the Close button. After the screen is closed, the selected time axis scaling factor will be effective.

- TIPS**
- Scaling factor can be changed without seeing the screen through the following steps.
 - 1) Press the left side of the time axis scaling button, and then make jog dial change effective. Scaling factor will be highlighted.
 - 2) Change the value by turning the jog dial.
 Time axis for waveform display will be enlarged or compressed according to the scaling factor.
 - 3) Peak data cannot be expanded.

14.8. Output Setup

Displayed data can be printed out or exported into a file. To execute data output, press the Output Setup button on the upper part of the Replay screen. Then the following screen opens. To output the waveform to chart paper immediately, press the Copy button.

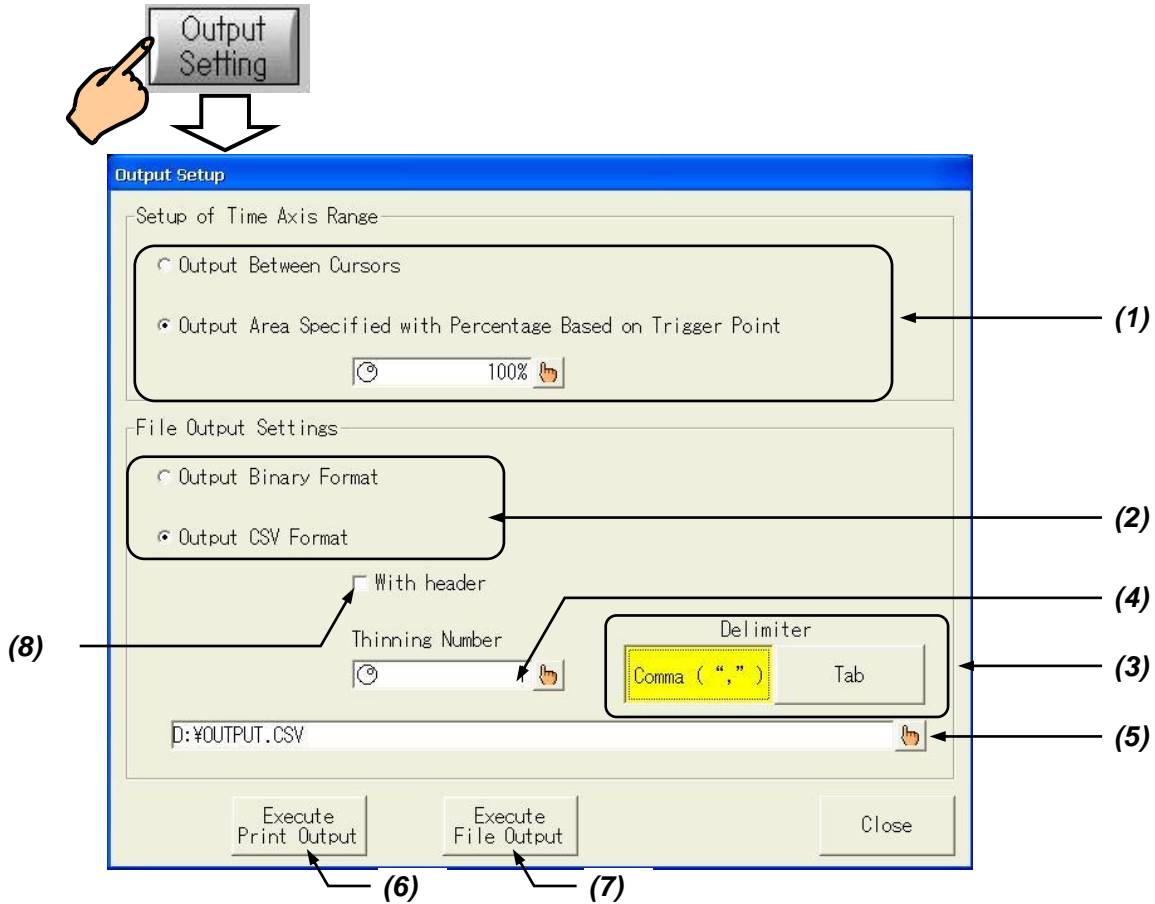

14.8.1. Specifying Output Time Range

Use the (1) button to specify the data output time-axis range. Select from among “Between cursors” or “Specifying in percentage in reference to the trigger point” If “Specifying in percentage in reference to the trigger point” is selected, specify percentage.

TIPS

To output all, select “Specifying in percentage in reference to the trigger point” and choose 100 for percentage.

14.8.2. Specifying File Save Format

Use the (2) button to specify the format at file save. Select Binary or CSV. If CSV is selected, the number of skip and delimiter can be specified. When data is saved is the CSV format, you can select (8) Use Header. Then, the header information such as amp setup as well as data can be saved.

NOTE

The file extension will be DRT that is output in the binary format. The binary save file can be referenced in the Replay screen.

NOTE

The file extension that is output in the CSV format will be CSV. The CSV save file size becomes 5 times as big as binary save file size. The CSV save file cannot be referenced in the Replay screen.

14.8.3. Specifying CSV Delimiter

Use the (3) button to specify the delimiter upon the CSV save. Select comma or tab.

14.8.4. Specifying Number of Skip in CSV

Use the (4) button to specify the number of skip in CSV save.

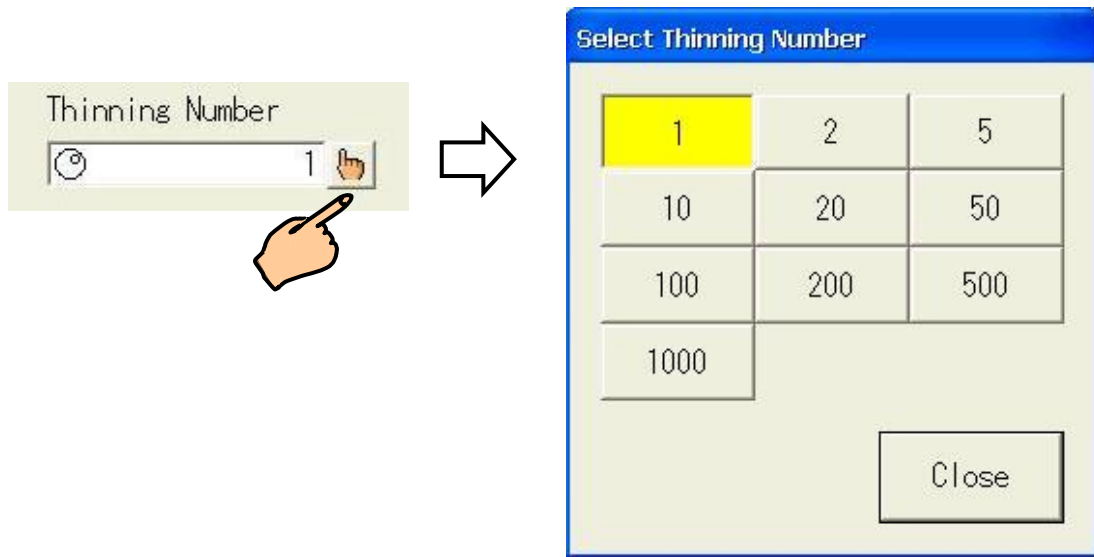

TIPS

Data will be rough if skipping is specified but it is possible to make file size small.

14.8.5. Specifying File Save Destination

Use the (5) button to specify the file save destination.

TIPS

The output file extension will be fixed. (Binary save = DRT, CSV save = CSV)

14.8.6. Execution of Data Output

Output to chart paper is made with the (6) button. File save is made with the (7) button.

TIPS

Output can be stopped with the Stop button on the Operation Panel. If the file save operation is terminated, the file being saved will be discarded.

NOTE

During the data output, the other operations do not start. Do not disconnect the connection to a drive during file save.

TIPS

To output two or more data correctly, use the File Operation on the System screen. For more details, see 16. System Setup.

14.9.Copy

Copy of selected file or folder is made. The following screen appears when the Copy button is pressed after selecting copy source items in the File Operation tab in the System screen.



14.10. X-Y Waveform Display

To display replay data in the X-Y graph, press the X-Y icon on the top of the screen. If the recorded data is the Sample format, X-Y display is made; if the data is the Peak format, X-Y display is not made.

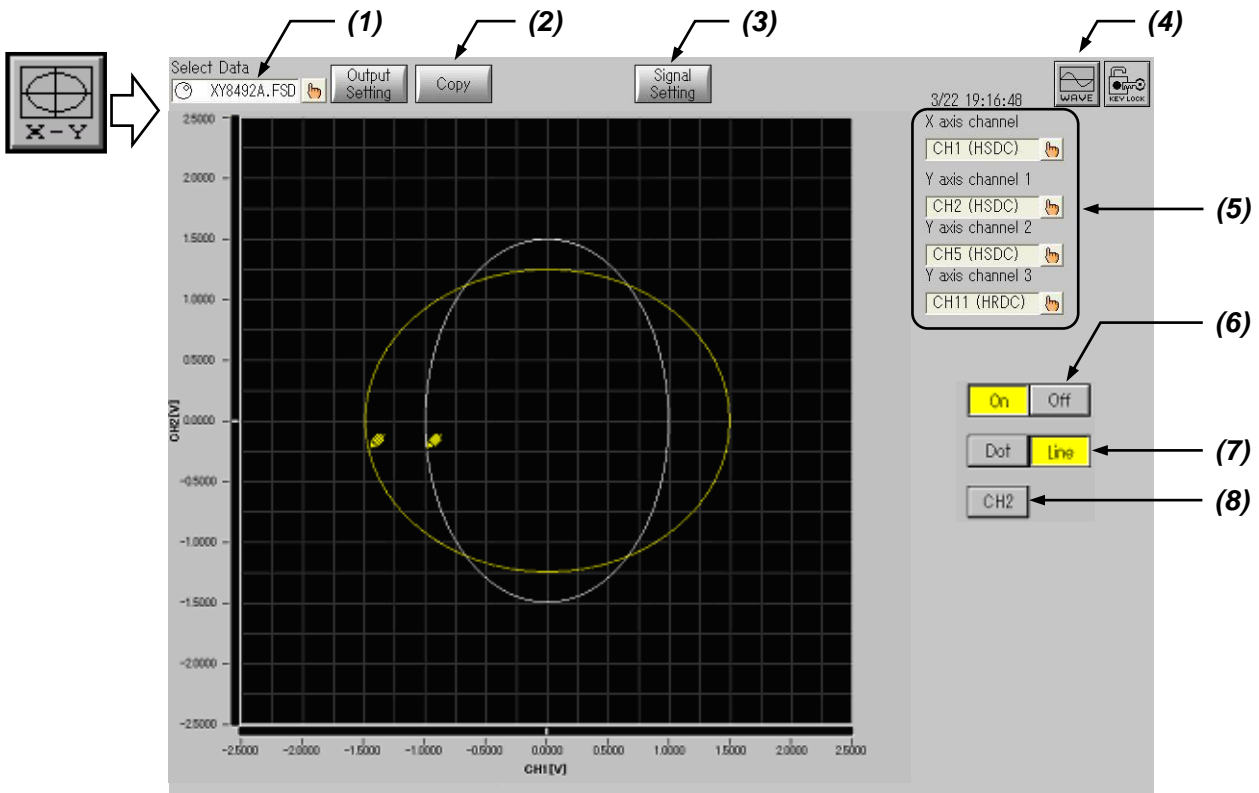

(1) Data selection

This portion displays the data file name whose data is being displayed. Pressing this button selects the data file to be referenced. The operations are the same as those for Y-T waveform display. For more details, see [14.2Replay Data Selection].

NOTE

The X-Y display is available only in the Sample format data. Choose the Sample format data, accordingly.

(2) X-Y Waveform Printout

The X-Y waveform being displayed will be output to the chart printing paper. Operations during outputting are disabled but forcible stop can be made with the Stop button on the Operation Panel.

(3) Signal setting

Signal setting information is displayed. The zero position and physical unit conversion settings are available.

(4) Switching to Y-T waveform display

Display is returned to the Y-T waveform display.

(5) Specifying X-Y axis channel

Specification of the X-Y axis channel is made.

(6) Switching to Gliding monitor display

It turns On and Off for Gliding display.

(7) Specifying data interpolation

Specifying data interpolation type of X-Y waveform either Dot or Line.

(8) Specifying Y scale

Y-axis scale is specified among selected channels. When multiple channels are selected, by pressing the button, each time channel number changes.

15. Display and Printing Settings for Monitor Display and Printing

15.1. Settings for Display and Printing

Display and Printing is used to set X-Y display of waveforms or printing format for waveform. Pressing the Display and Printing button on the Operation Panel opens the screen for settings.

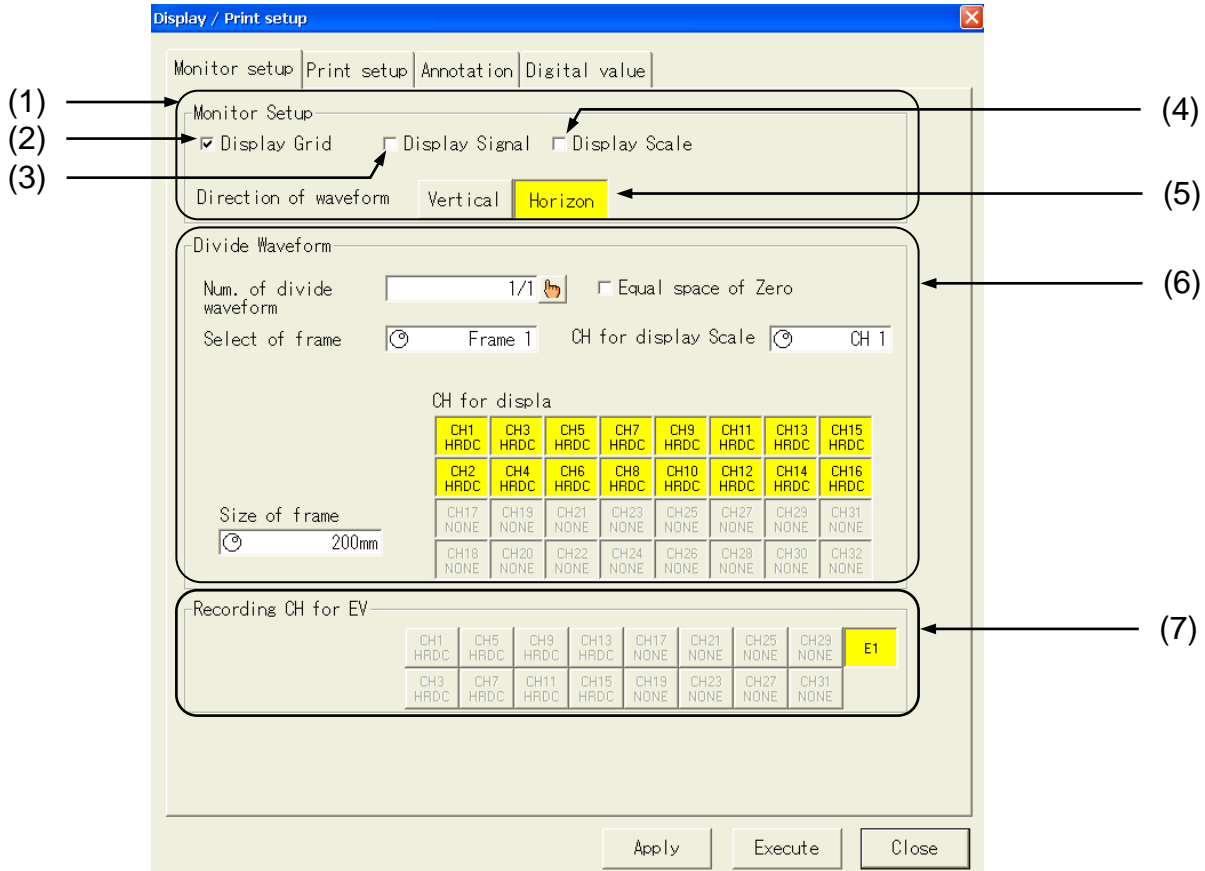

15.1.1. Monitor Display

(1) Monitor Display Setup

This section is used to set monitor display screen for Pen Recorder, Memory Recorder, HD Recorder, or Multi-Recorder.

(2) Grid Display

This check box is used to set the grid indication for the waveform display area to ON or OFF. Grid display is effective through (tick).

(3) Signal name indication

This check box is used to set the signal name indication for the waveform display area to ON or OFF. Signal name indication is effective through (tick).

TIPS Signal name can be set in 15.3 Annotation Setting

(4) Scale Display

This check box is used to set the scale indication for the waveform display area to ON or OFF. Scale indication is effective through (tick).

NOTE The scale is indicated in one line. If there are several channels in one waveform frame, the scale of the channel is indicated for the selected frame set in the waveform segmentation setting..

(5) Scrolling Direction

Selection of Vertical or Horizontal for the scrolling direction in the waveform display area can be made.

(6) Divide Waveform Setup

It is possible to set the number of segmentation of waveforms that are displayed on the waveform display area. In addition, segmented frame size and channel to be displayed can be set.

(7) Event Waveform Record Setup

Channels whose event waveforms are recorded. Up to eight channels can be used for recording. The recorder event is regarded as the size equivalent to two channels.

15.1.2. Display

It is possible to set the number of segmentation of waveforms that are displayed on the waveform display area. In addition, segmented frame size and channel to be displayed can be set.

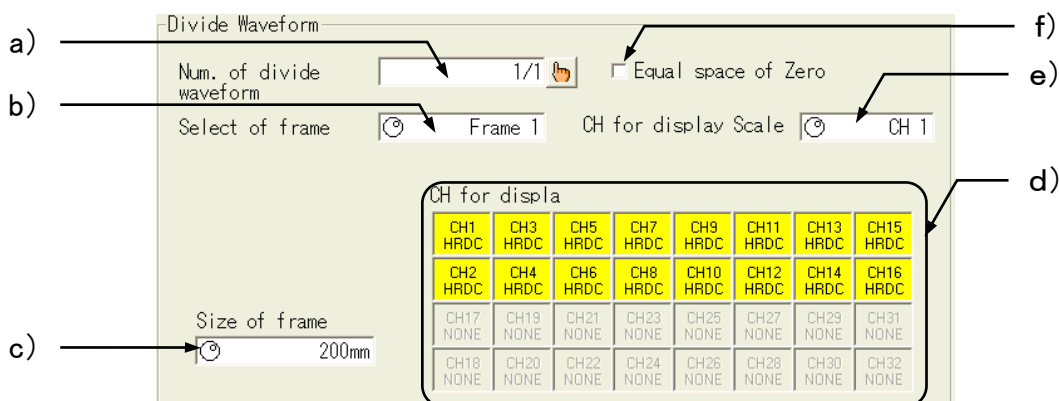

a) Number of segmentation for recorded waveform

Number of segmentation for recorded waveforms can be made. Any number from 1 through 16 can be set.

b) Frame selection

Frame created through the segmentation of recorded waveform can be selected. The 1st frame is assigned to the top in the horizontal direction and to the left in the vertical direction.

c) Frame size

Frame amplitude direction size can be set.

d) Channels to be displayed

Channels displayed in the frame can be selected.

e) Scale indication channel

Specify the channel to be displayed when the scale indication for monitor display setting is set to ON.

f) Equal positioning

The 0 position for the channel indicated in the frame selection is equally allocated. After the equal positioning is selected, pressing the [Execute] button execute the positioning.

NOTE

The frame size is limited so that the entire frame size plus margin is to be within the effective recording range (216 mm).

15.2. Print Setting

Display the Print Setting screen by pressing the Display and Recording button when setting the printing format for waveforms.

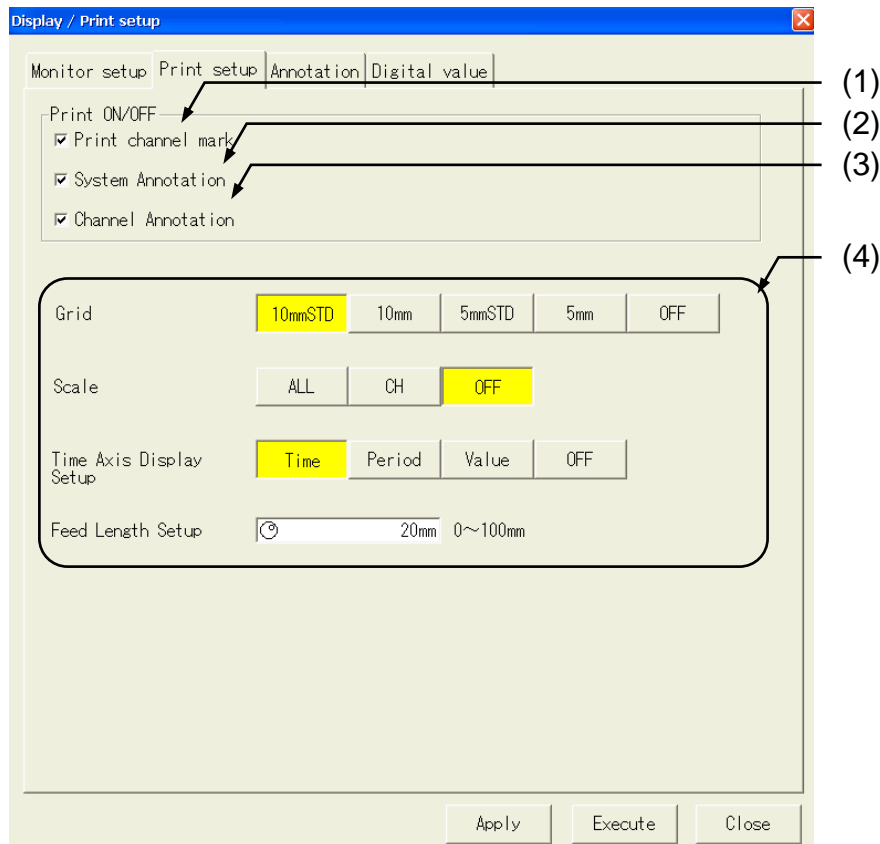

15.2.1. Print to ON or OFF

(1) channel mark

Set the channel mark (channel number) print to ON or OFF. The channel mark print is ON with (tick).

(2) system annotation

Set the system information print related to printing to ON or OFF. The system annotation print is ON with (tick).

Example 8.3 Recording Operations

(3) channel annotation

Set the acquisition condition print to ON or OFF. The channel annotation print is ON with (tick).

Example 8.3 Recording Operations

15.2.2. Print Setting

Settings for grid interval, amplitude axis scale, time axis representation, and other settings for waveforms can be made.

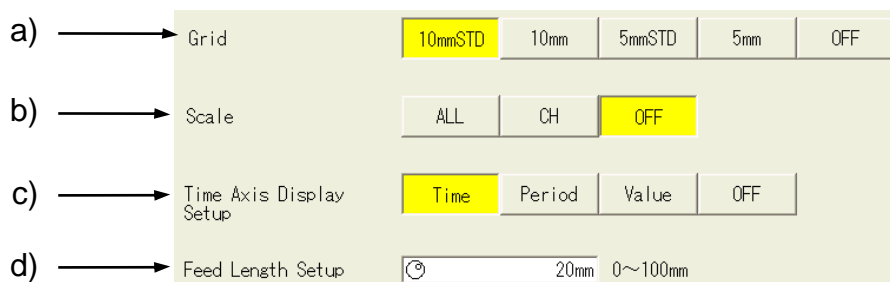

a) Grid

Grid pattern for waveforms and X-Y recording can be made.

Grid	Graduation mark	Auxiliary grid
10 mm STD	Every 10 mm	1 mm auxiliary grid
10 mm	Every 10 mm	NA
5 mm STD	Every 5 mm	1 mm auxiliary grid
5 mm	Every 5 mm	NA
OFF	NA	NA

b) Amplitude axis scale

The amplitude axis scale print can be set.

Only the max. and min. values are printed in one line when Batch is selected. (Scales between max. and min. are not printed)

Not only the max. and min. values but also in-between scales are printed on one line. Since one line is needed for printing one channel, more chart paper will be consumed.

The amplitude scale is not printed during OFF.

TIPS

To save the chart paper, it is recommended to select Batch.

c) Time axis representation

The unit for waveforms can be selected from among Recording time, Date and time, Number of data, and OFF.

TIPS

If the acquisition speed is set to be external synchronization, the representation in Recording time and Date and time cannot be made.

- “Recording time” is data acquisition time. The trigger point is the reference point (0) in the Memory Mode.
- “Date and time” prints the date and time of recording and trigger point (year, month, day, hour, minute, and second).
- “Number of data” is the data count. The trigger is the reference (0) in the Memory Mode.

d) Field length setting

This setting sets the length of the feed that is executed after the printing,

When making continuous printing or minimize the chart paper consumption, set the value as small as possible. Conversely, to show the last portion of data that have been recorded set the value as large as possible.

15.3.Annotation Setting

This screen is used to set signal name, user annotation, and measurement information.

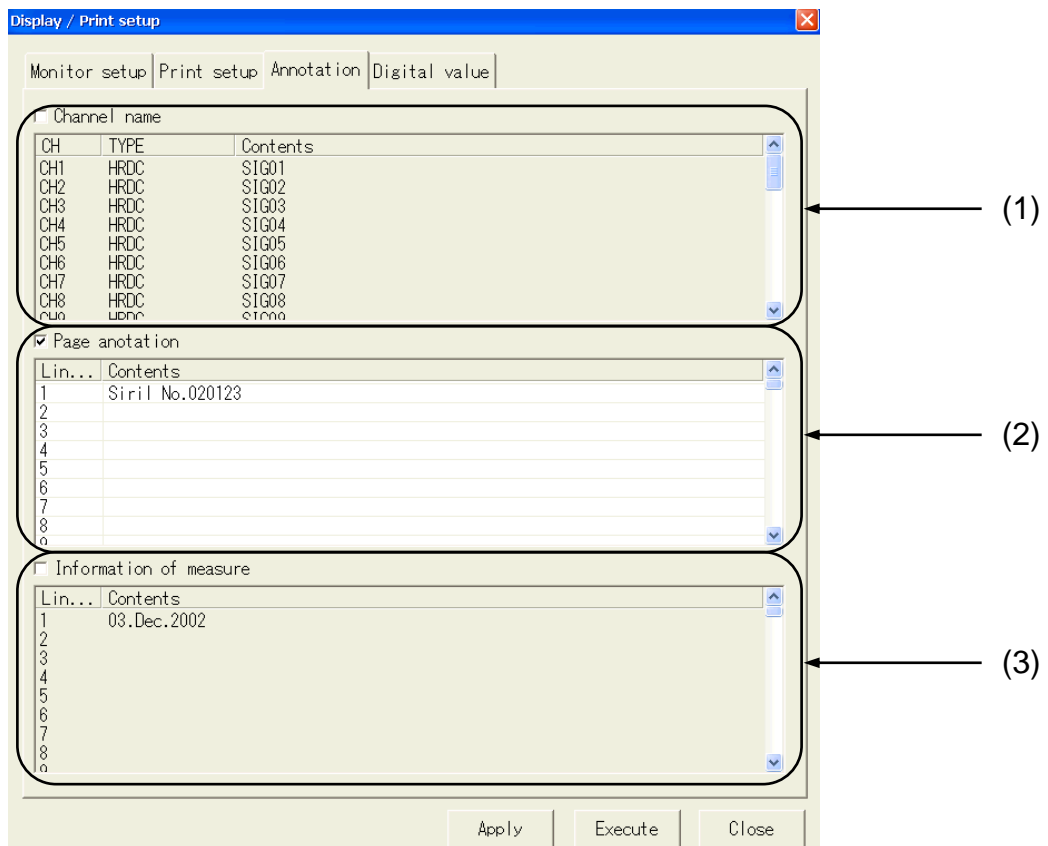

(1) Signal name

Signal name for the waveform display area can be set

TIPS

Monitor display is made when the signal name indication is ON in 15.1 Monitor Setting

(2) Page annotation

It is possible to set the character strings following the system annotation that overlaps the waveform and its printing ON or OFF.

Page annotation is ON with (tick).

TIPS

Example  8.3 Print Operations

(3) Measurement information

Set the setup and printing for measurement information the top of the chart paper to ON or OFF.

The measurement information is ON with (tick).

TIPS

Example  8.3 Print Operations

15.4.Digital value representation Setting

This screen is used to set signal name, user annotation, and measurement information.

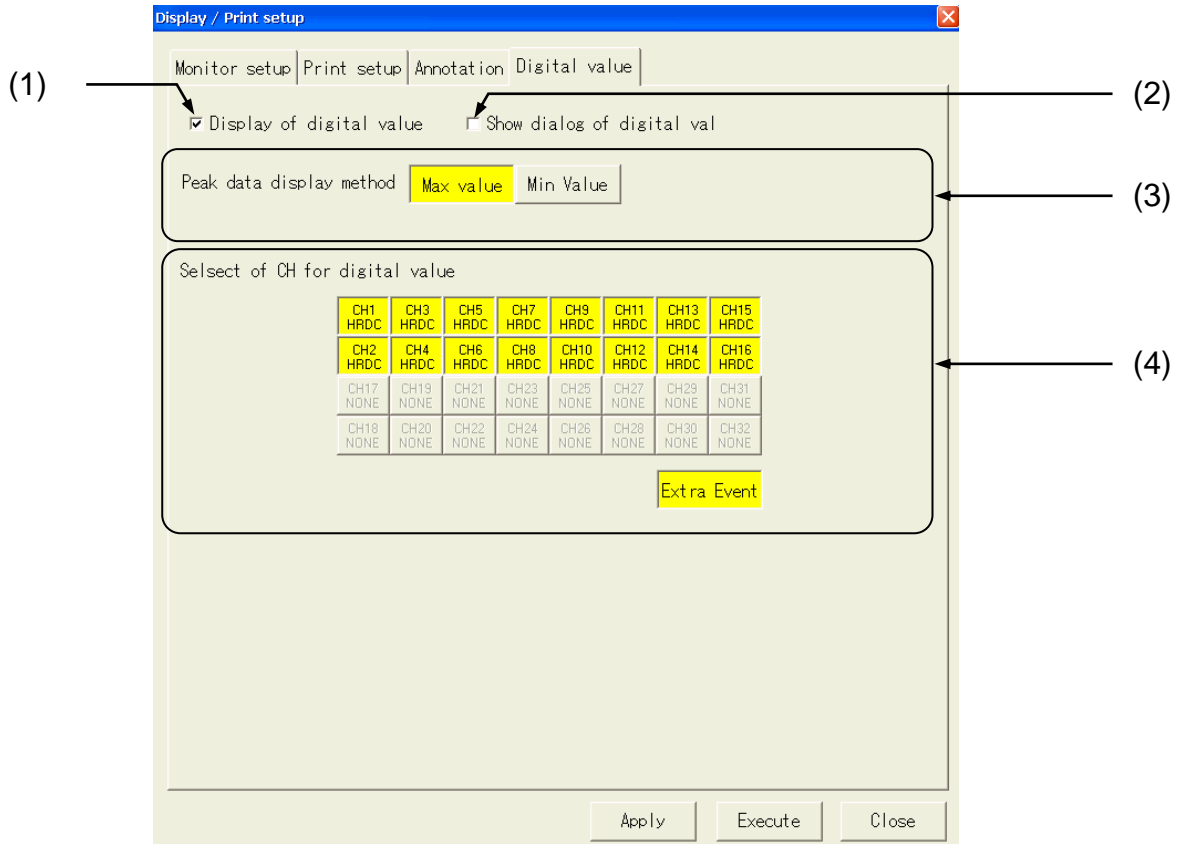

(1) Digital value representation

Digital value representation in the waveform display area is set to ON or OFF. The digital representation is ON with (tick)

(2) Digital value representation

The digital value representation is made in the dialog box. The digital value representation in the dialog box is ON with (tick).

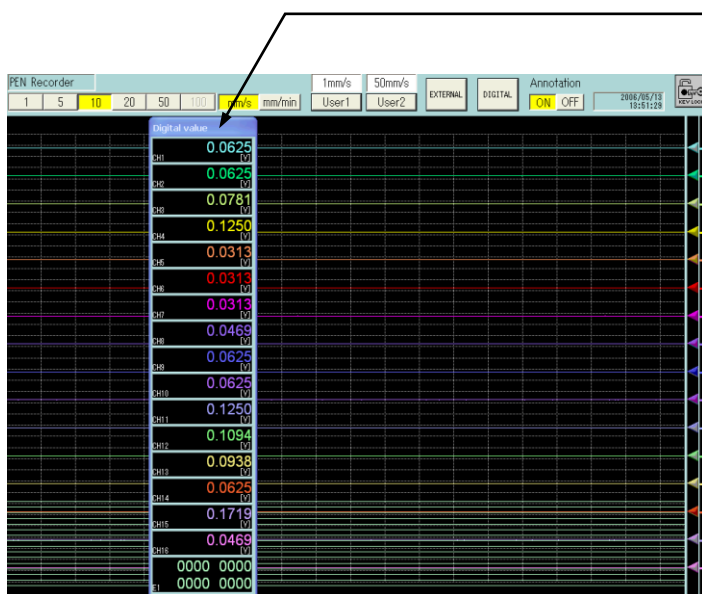

Digital value representation

The dialog box can be moved to any place on the screen. To move it, touch the upper portion of the box, and then move it.

(3) Digital value representation

While the Peak data is referenced on the replay monitor, representation in the maximum value or minimum value can be set.

(4) Channels for which digital value representation

Channels for which digital value representation is made can be set.

16. System Setup Other Functions

16.1. Commonly Used System Screen

Termination and USB Storage Disconnection, which are frequently used in the System screen, are placed on the front.

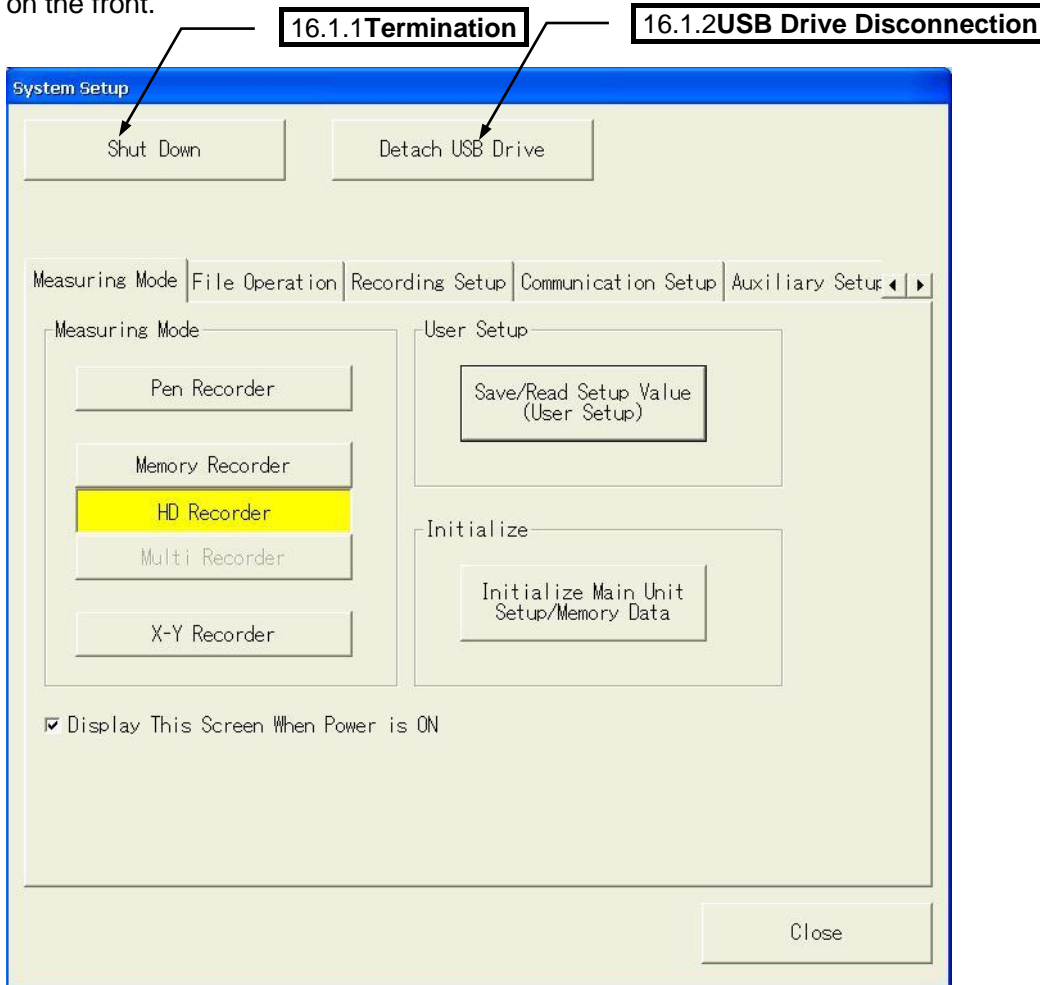

16.1.1. Termination

This button initiates the termination processing of the recorder. After message of “You can shut off the power” appears, turn off the power of this recorder.

Block data that is stored in a memory is saved. The data that is saved resumes at the next startup of the recorder.

TIPS

When the block of “Don’t save wave memory” is ticked after ticking of the box of “Shit Down”, it is possible to do much rapider termination processing

16.1.2. USB Drive Disconnection

This button is used to disconnect the USB storage devices that are connected to this recorder. After this button is pressed, message of “You can disconnect USB devices” appears. Then, disconnect the USB device.

NOTE

USB storage device disconnection should be made while recording is not made. If the disconnection is made during recording, an error may occur. Use the USB storage device that is recommended by NPPON AVIONICS.

16.2. Measurement Mode

In the Measurement Mode screen of the System screen, measurement mode settings for this recorder as well as saving, readout, and initialization of all setup information can be made.

Pressing the System button and the Measurement Mode tab on the operation panel displays the following screen. The same setup can be made in the Startup Screen that is displayed upon the startup.

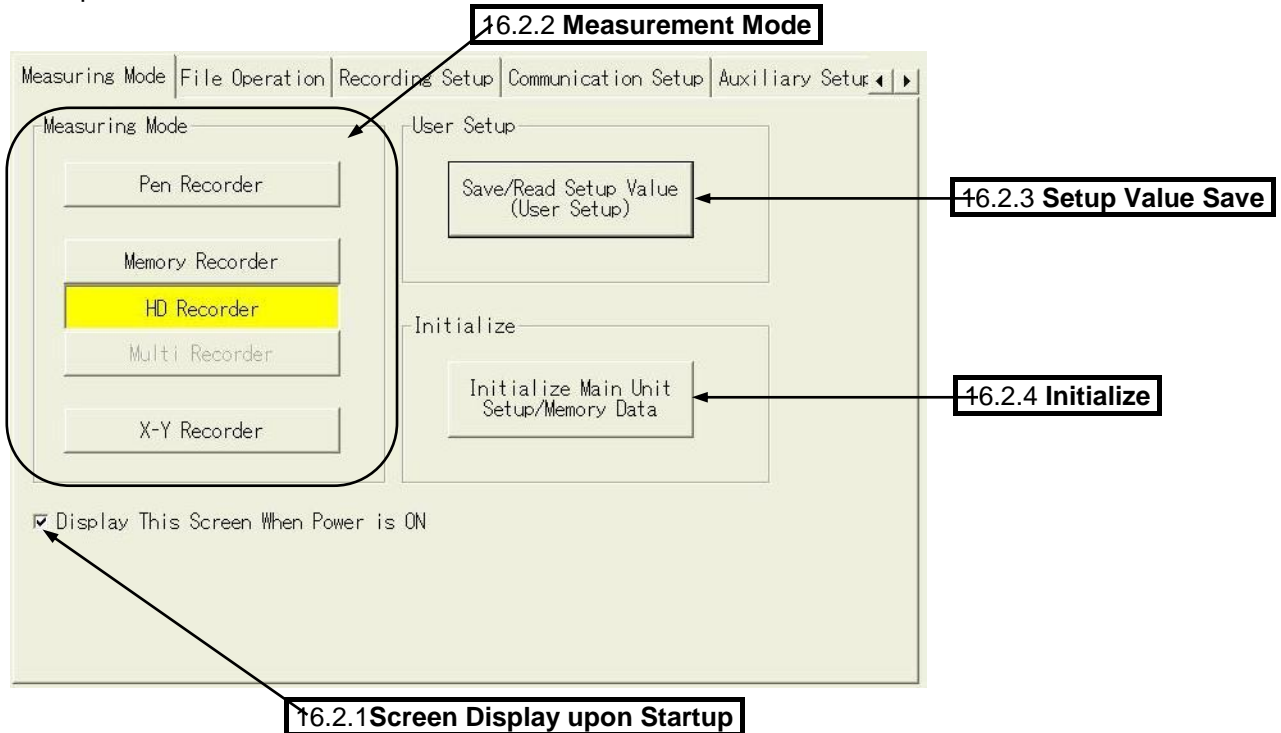

16.2.1. Screen Display upon Startup

This screen can be opened upon startup when the check box is ticked. If this recorder is used under the condition whose measurement mode is fixed, recording can be made immediately after the recorder is turned on when this check box is not ticked.

16.2.2. Measurement Mode

Measurement mode can be changed. Pressing the measurement mode button displays the Window for confirmation. To execute, press the OK button. The Input Monitor screen appears. The following screen appears when the Memory Recorder button is pressed. The same screen appears for other measurement mode.



16.2.3. Setup Value Save and Readout

The settings of this recorder can be saved in or read from the internal memory. Comments can be entered, which makes it useful to recognize file. Additionally, setup can be indicated as a list.

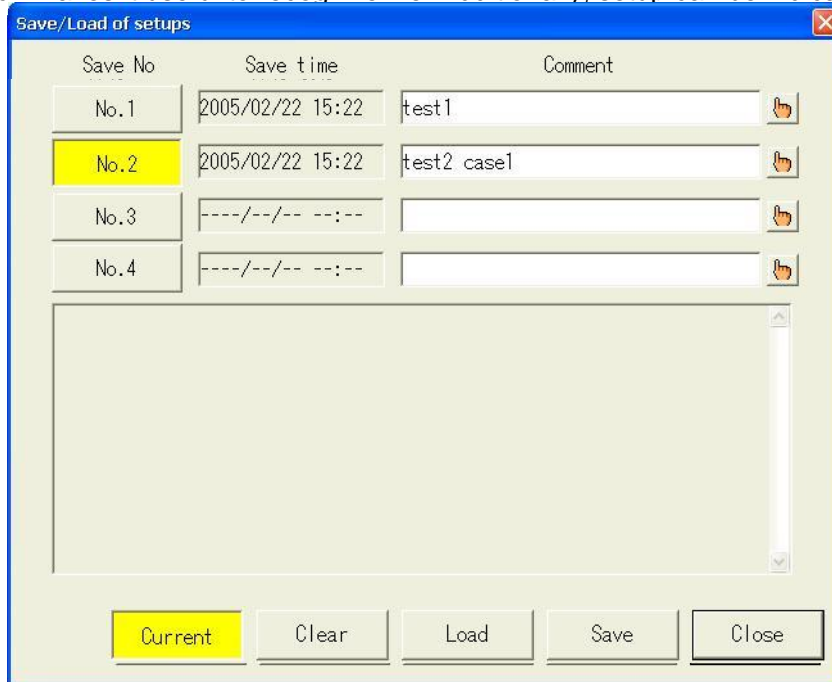

16.2.4. Initialize

The setup of this recorder can be resumed to the factory default. Also, the item to be initialized can be set.

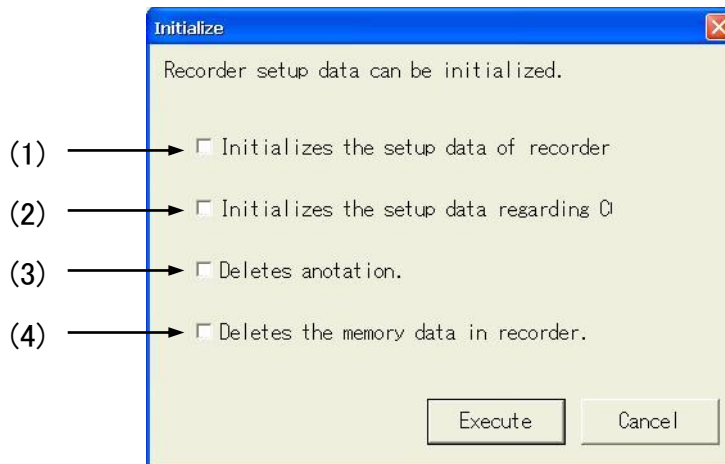

(1) Recorder setup data

The setup status can be resumed to the factory default.

(2) Setup data related to communication

Communication setup can be initialized to the factory default.

(3) Annotation

Deletion of user page annotation, measurement information, and signal name are made.

(4) Internal memory data

Data in memory blocks are all deleted.

16.3. File Operations

File operations are made for the drives through the File Operation tab on the System screen. Press the System button on the operation panel and the File Operation tab to show the following screen.

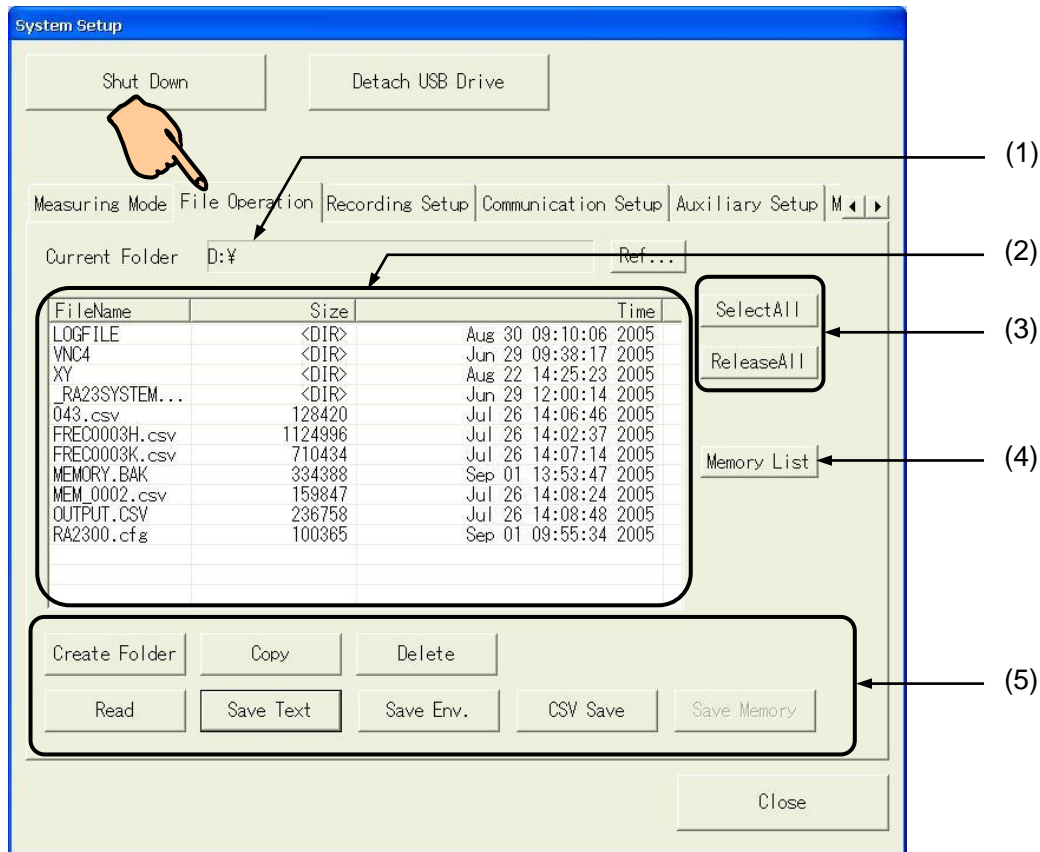

(1) Path for referencing or saving target

Path for referencing or saving target is displayed. Pressing a button opens a dialog box, and then can change the path.

(2) List

Target reference file folder list is displayed. The selected item is highlighted. Change can be made through direct touching.

(3) Batch selection

Select two or more files in a folder. Copy or Delete is available for batch selection file. In case of "Bulk-Delete", data is very important for Recorder. So system shows on the screen, "Delete" or "keep" for confirmation individually.

(4) Memory List button

The status of the memory on the inside is displayed in the list part.

(5) Other file processing

Several file processing is made for the file in the target reference path. For more information, see the description after the next page.

NOTE

To protect the recorder system, writing into the boot drive (C) is prohibited. Thus, file creation and deletion in the C drive cannot be made.

16.3.1. Copy

Copy of selected file or folder is made. The following screen appears when the Copy button is pressed after selecting copy source items in the File Operation tab in the System screen.

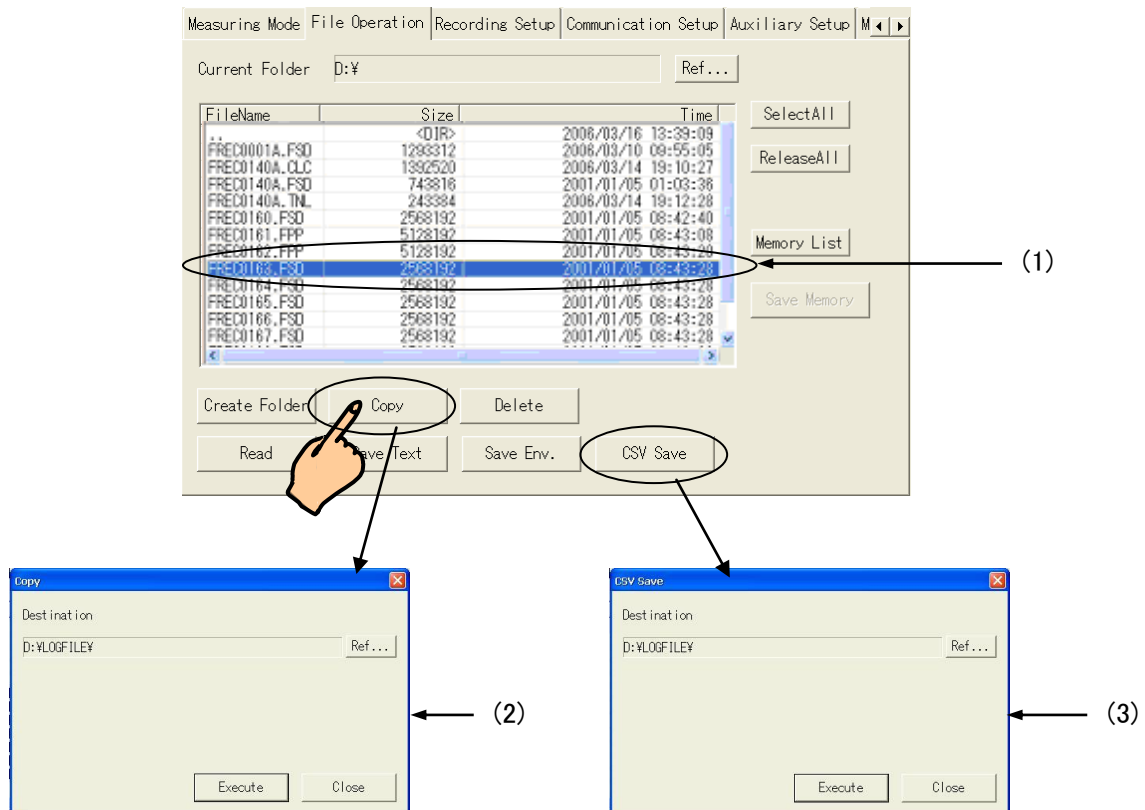

(1) File folder for copy source items

You can specify source files for copying in file operation screen by touching these files.

Please use this function for assuring copying files.

TIPS

Copy for several files is available when batch selection is made in the File Operation screen.

(2) Destination file for copying

It is specifying destination file for copying. By pressing key buttons, a dialog is opened and you can change your destination file.

(3) CSV save

If these copy source items saved as "FSD" and "FPP" extensions, these files can be modified and saved their format as CSV files.

TIPS

"Time axis range", "Thinning-out", "Header", and "Delimiter code" can be specified in Output Settings in the Replay screen. For more details, see Chapter 14 Replay Display.

16.3.2. Delete

Selected files or folders are deleted. The following screen appears by pressing the Delete button after selecting the deleting files or folders in the File Operation tab in the System screen.

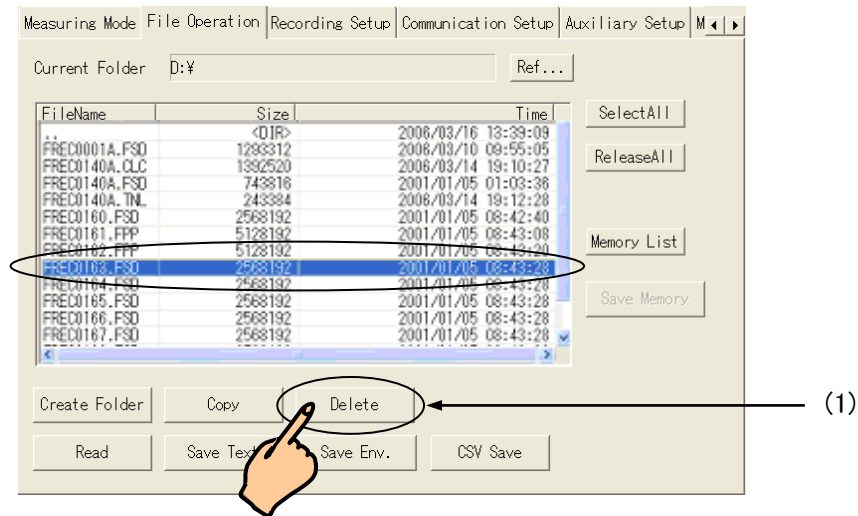

(1)Delete

Selected files or folders are deleted. The following screen appears by pressing the Delete button after selecting the deleting files or folders in the File Operation tab in the System screen.

NOTE

The deleted files and folders cannot be recovered. Take due care before deleting. When the file in the folder is displayed on the Replay screen, it is not possible to delete it.

16.3.3. Create Folder

New folder can be created under the current target reference folder. Pressing the Create Folder key after moving to the path where a folder is created in the File Operation tab in the System screen. Enter a folder name and press the OK key to make folder.

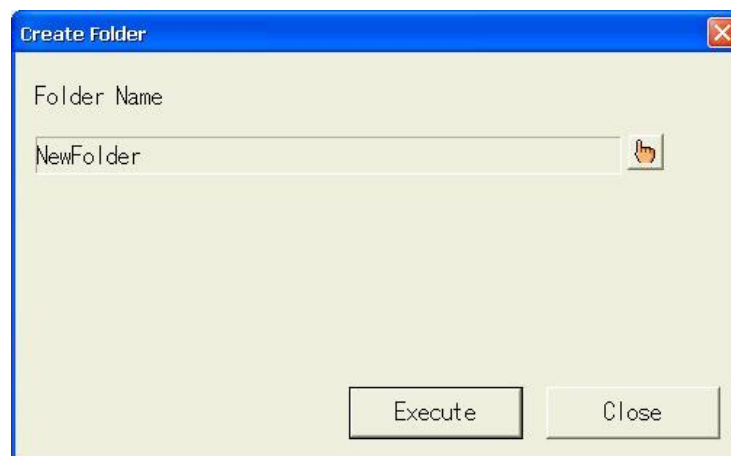

16.3.4. Save Memory

The block data stored in memory can be saved. The following screen appears by pressing the Memory List button and Save Memory button after moving to the folder where data will be saved in the File Operation tab in the System screen.

(1) Glance Memory List
Pressing Memory List

(2) Memory Block List
It shows the list of memory blocks.
You can select part of the list.

(3) Save Memory
It indicates path where data will be saved.
By pressing the button, you can save the data.

(4) CSV save

In the case extension of source files are "FSD""FPP" or "DRT", you can save their format as "CSV".

TIPS

In regard to CSV save, "Time Axis Range" "Thinning Number" and "CSV Delimiter" are able to be setup in the Replay screen in Output setting views. For more detail, please see "Replay display", Chapter 14-8.

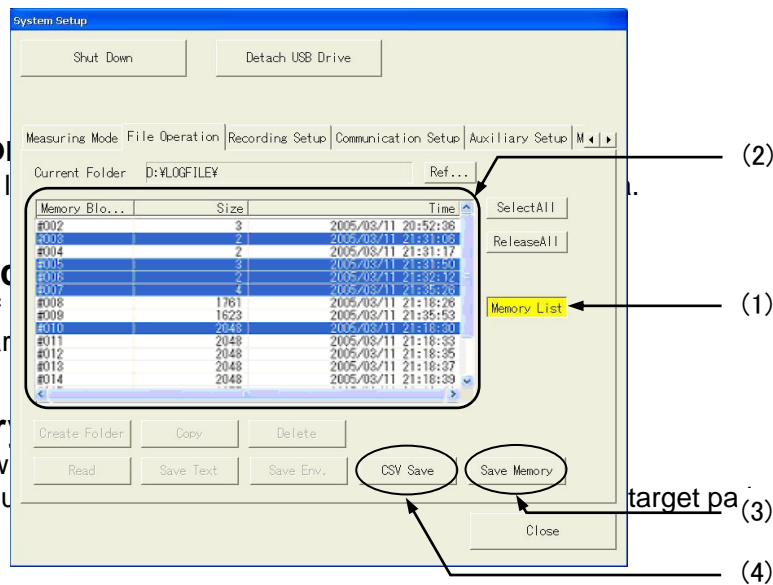

16.3.5. Save Env.

Setup information can be saved in a file. It is useful to save the setup information in external media or read out it from another RA2300 recorder. The following screen appears by pressing the Save Env. button after moving to the folder where saving is made using the File Operation tab in the System screen. Save Env. Data includes all the setting information as a binary format. In addition to that, if you save annotation of this text information only, push "Save Text" button.

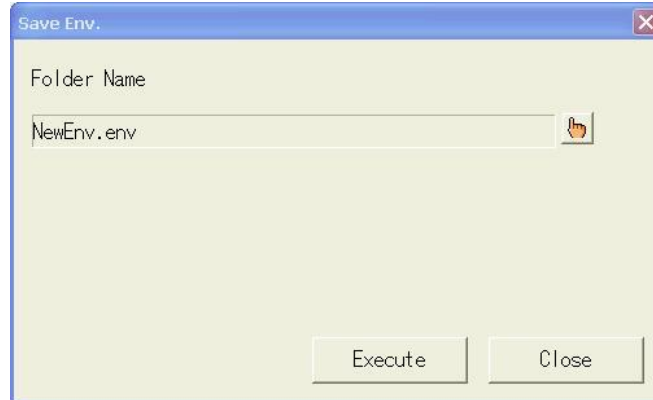

After specifying the information to be saved, press the OK button to save file. The extension of file to be saved is ENV for environment information and TXT for text information.

TIPS

The file made by character strings only has an extension of "txt". A text editor can read this file, accordingly. Conversely, a text file edited by a personal computer can also be read by the RA2800A.

NOTE

If an environment file is read by another RA2800A, the setup in which hardware configuration is different is displayed to be default.

16.3.6. Read

The selected environment and text files can be read in this recorder. The following screen appears by pressing the Read button after selecting a readout file using the File Operation tab in the System screen



16.4. Recording Settings

Press the System button, and then press the Recording Settings tab. The following screen appears.

System Setup

Shut Down Detach USB Drive

Measuring Mode | File Operation | Recording Setup | Communication Setup | Auxiliary Setup | M

Change Memory Capacity

CH1 HRDC	CH3 HRDC	CH5 HRDC	CH7 HRDC	CH9 HRDC	CH11 HRDC	CH13 HRDC	CH15 HRDC	
CH2 HRDC	CH4 HRDC	CH6 HRDC	CH8 HRDC	CH10 HRDC	CH12 HRDC	CH14 HRDC	CH16 HRDC	
CH17 ..	CH19 ..	CH21 ..	CH23 ..	CH25 ..	CH27 ..	CH29 ..	CH31 ..	E1
CH18 ..	CH20 ..	CH22 ..	CH24 ..	CH26 ..	CH28 ..	CH30 ..	CH32 ..	E2

The memory capacity for each channel can be increased by reducing the number of available channels.

Total MEM size 3436999W/CH

Data No. 0001

Speed Table Setup

Timer Function

Use Start Timer Function. Use Interval Recording Function

Start Time 0000/00/00 00:00:00 Start Int 1min

Stop Time 0000/00/00 00:00:00 Duration 1min

Close

16.5.1 Recording Channels

16.5.2 Data No. Setting

16.5.3 Recording Speed Table

16.5.4 Timer Recording Settings

16.4.1. Recording Channels

By restricting the number of recording channel, memory capacity per channel for memory recording can be increased. In the System screen, use the Recording Settings. Pressing Recording Channel displays the following table.

TIPS

Channels excluded from the recording target are neglected. Even a unit is installed, nothing is displayed. If recording channel settings are changed, the memory size changes, thereby deleting the memory block data.

TIPS

E2 denotes the marking information of the internal function of the RA2800A. By setting E2 to ON, (7.1.3 Recorder Event Detailed Setting), Marking is made on the recorded data by pressing the Manual Trigger Marking switch on the operation panel. Event jump can be made after the trigger detection point (marking information) is researched.

For details of Event Jump, Refer to 14.6 Jump.

16.4.2. Data No. Setting

The number that is assigned to the measurement data can be changed. In the System screen use the Recording Settings screen. Pressing the button of Data No., displays numeric pad, enabling value data entry.

TIPS

The data number increments automatically after recording. This function is useful to identify the recording data order. The data number can be confirmed on the upper portion of the waveform printing and replay monitor.

16.4.3. Recording Speed Table

User can sets the speed for waveform chart printing, memory recording, and HD recording. Press the System screen, and then press the Recording Settings screen. Pressing the Speed Table button, displays the following screen.

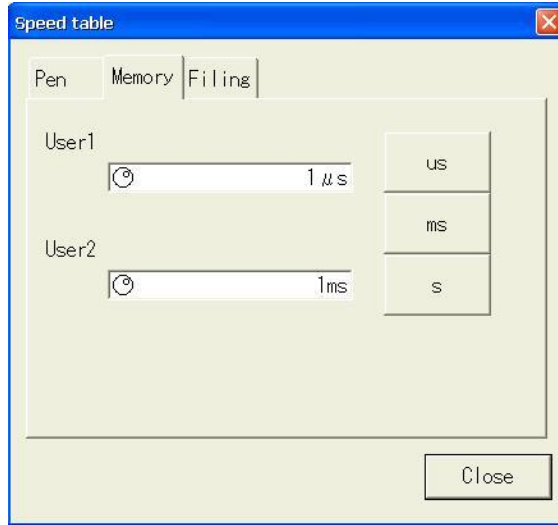

16.4.4. Timer Recording Settings

Recording start and finish is controlled by time.

Recording start and finish can be set to the time whose timer function can be validated. Recording operation in constant interval and constant time is available. Press the System screen, and then press the Recording Setting screen. opens the following screen. (Please input the Stop time when you use the start timer and Interval function)

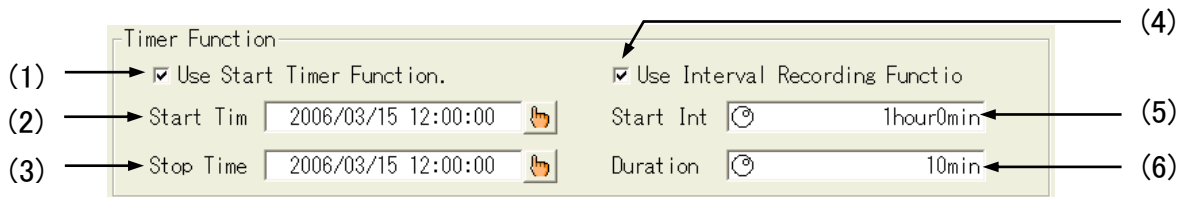

Select “start time” or “start timer function” setting and then make setting for “Start time” or “Finish time”.

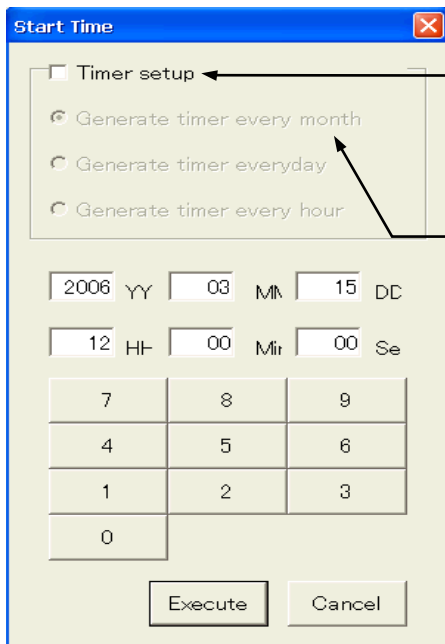

By removing a check in interval function, you can specify year, month, day, time, minute and second to be activate, whereas remove the check you cannot specify all these.

E.G. If you specify “Every month”, year and month becomes unnecessary to setup. Day, time, minute and second are only to be able to be specified.

TIPS

Besides the setting of “Every month”, “Every day” and “Once an hour”, a combination of “interval setting” makes more varies setting possible.

Combine with "Start timer function", using the "interval function" makes possible to repeat Start/Stop in certain interval regardless of Standard time.

Example: To make 20-minute recording every hour from 0:00 a.m. on December 24, 2004 to 0:00 a.m. on the next day.

- (1) **Tick the box for "Using Start Timer Function."**
To use timer function, add a check mark.
- (2) **Select the starting time** (2004/12/24 0:00)
- (3) **Select the finish time** (2004/12/25 0:00)
- (4) **Tick the box for "Use the interval function."**

TIPS

Add a check mark only when repeated recording is made.
Do not tick if the measurement is only once.

- (5) **Specify the start interval of time** (1 H)
- (6) **Specify the operation time.** (20min)

TIPS

The actual recording operation time may be shortened depending on the recording length settings. When the timer function is set, a symbol of clock is displayed upper part of the screen. (It is not displayed in the pen recorder and the X-Y recorder mode.)
The next recording start time is indicated near the clock. See below.

Start 
12/31 23:50

16.5. Communication Settings

Press the Communication Settings tab on the System button on the Operation Panel. The following screen appears.

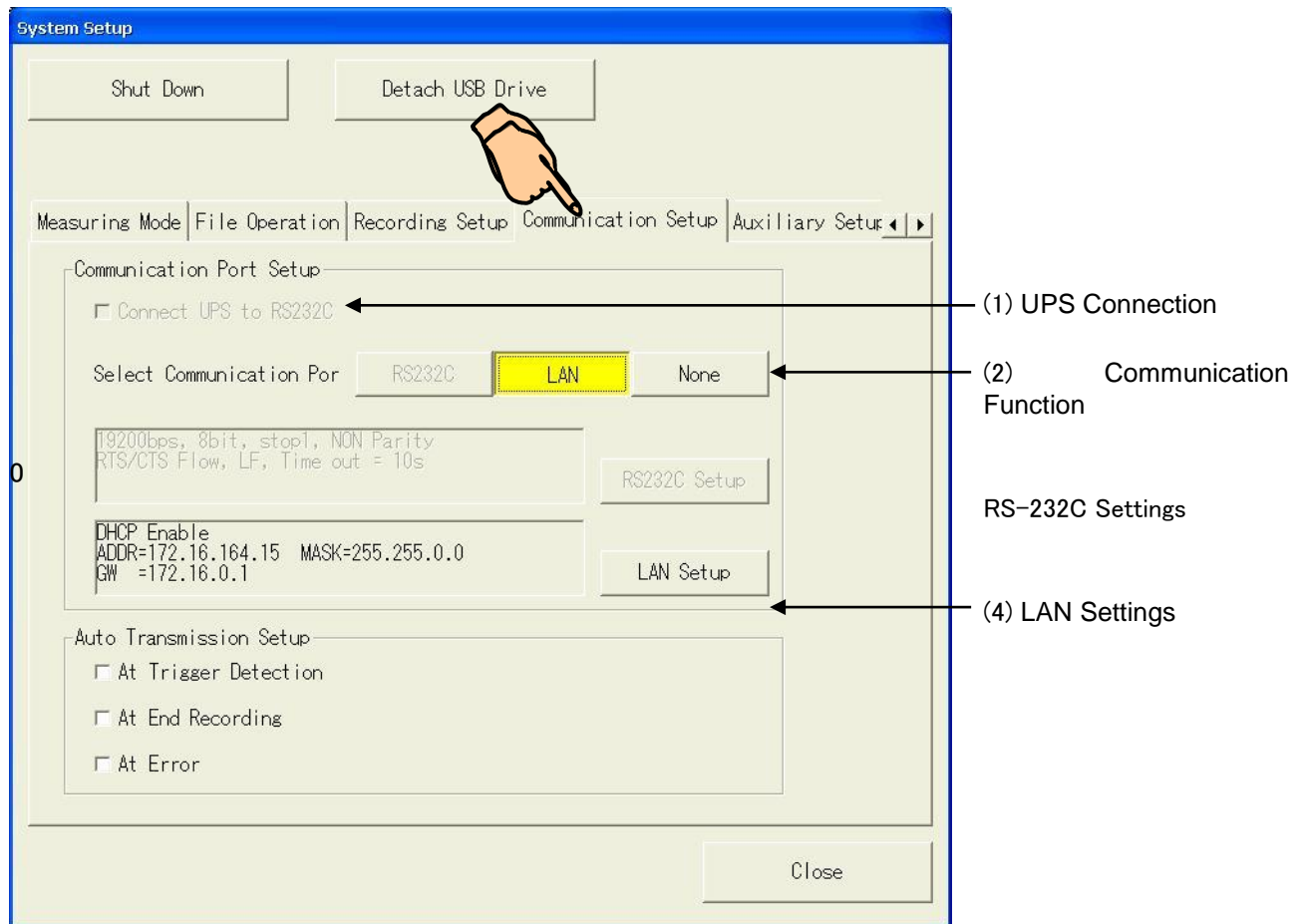

NOTE

To use the USP or RS-232C function, RS-232C Unit (RA23-142, optional) is necessary.

(1) UPS Connection

Connection to uninterruptible power supply (UPS) can be made by ticking the check box. The UPS avoid sudden shutdown of the recorder upon the electric power outage, enabling safe shutdown of the recorder.

(2) Communication Function

The control of RA2300 through a communication port is possible through this function

Setup	Description
RS-232C	Control of this recorder through RS-232C can be made. (Cannot be used with the UPS connection)
LAN	Control of this recorder can be made through TCP/IP port No.2300.
None	Control of the recorder through a communication port is disabled.

NOTE

Communication control for this recorder uses dedicated communication commands. For more detail, refer to separate volume instructional manual, "RA2000 series communication User's manual (Integrated Version)". This charge-free manual, PDF file is available by downloading through our home page with your user registration.

(3) RS-232C Settings

RS-232C communication protocol can be set. Pressing this button displays the screen below. Set the RS-232C conditions in this screen.

RS-232C

Baudrate: 2400, 4800, 9600, 19200, 38400

Data bits: 8, 7

Stop bits: 1, 2

Parity: NONE, ODD, EVEN

Flow control: RTS/CTS, XON/XOFF

Delimiter: CR+LF, CR, LF

Timeout: 10s

Execute Cancel

(4) LAN Settings

Communication protocol setup for the LAN connection is made. Pressing this button displays the screen below. Set the LAN conditions through this screen.

LAN

IP address: 172.16.164.15

Sub net mask: 255.255.0.0

Gateway address: 172.16.0.1

Use DHCP

Delimiter: CR+LF

Time-out: 10s

Execute Cancel

(5) Automatic Message Output

Character code "1" is output when one of the conditions "Trigger detection", "Recording finish", "Error generation" is generated in RS-232 or LAN connection.

This function may be used in the case where an operation enters into the next step when the connection target supports this character code. For details, refer to separate volume "RA2000 Series Communication Command User's Manual (Integrated Version)". This charge-free manual, PDF file is available by downloading through our home page with your user registration.

16.6. Auxiliary Settings

Press the System button on the Operation Panel, and then press the Auxiliary Settings tab. The following screen appears.

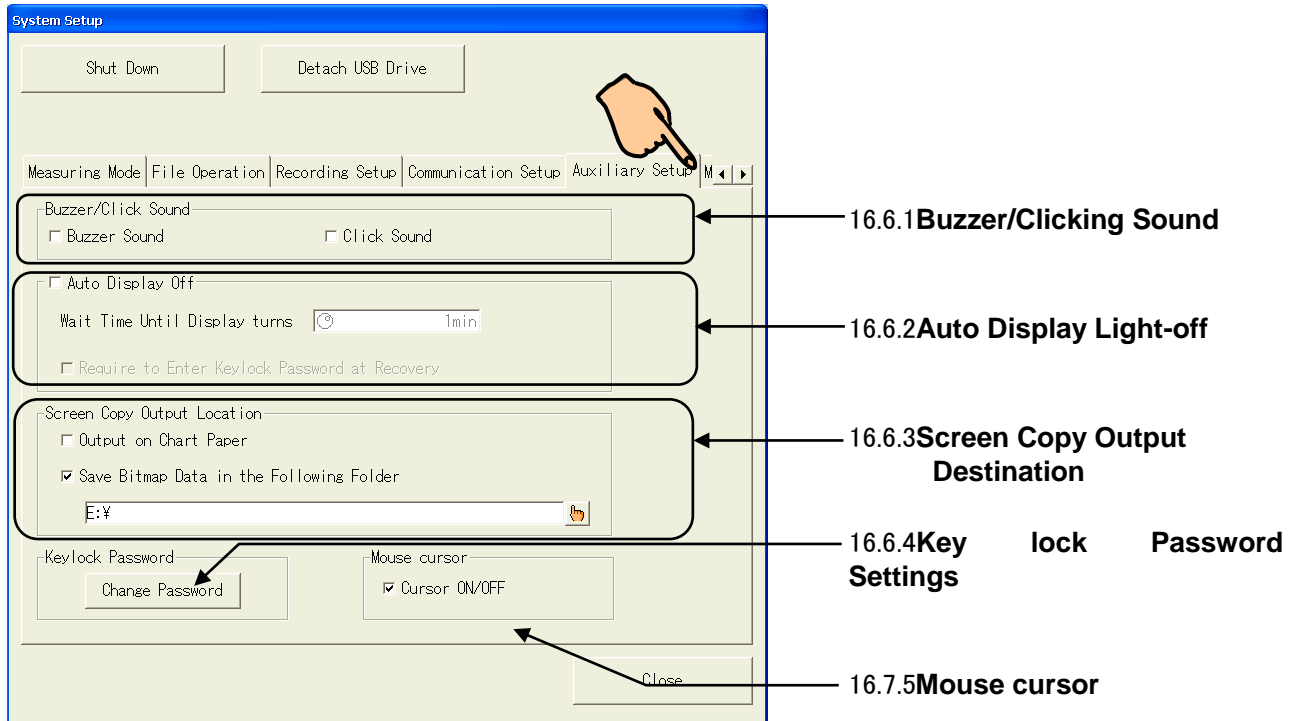

16.6.1. Buzzer/Clicking Sound

Buzzer and clicking sound can be set to ON or OFF in the check box (1) on the Auxiliary Settings screen. Buzzer sound upon error generation and clicking sound upon pressing on a touch button can be turned OFF its sound.

16.6.2. Auto Display Light-off

Back light-off can be set using the keys (2) on the Auxiliary Settings screen. This function turns off the back light if no entry from a button is made for a specified time period. Upon an entry through a button, the back light turns on.

TIPS

When check box for “Enter key lock password at resume,” the password must be entered when back light is resumed from display back light off. The password is set using button (4).

16.6.3. Screen Copy Output Destination

Output destination for screen copy that is executed in the Screen Copy on the Operation Panel can be set using buttons (2) on the Auxiliary Settings screen.

- Ticking the box for “Print on chart paper.” prints out the contents of the screen in a black and white image.
- Ticking the box for “Save bitmap data in the following folder.” exports the contents of the screen in a color bitmap file.

TIPS

The file name to be saved is made by data and serial number.

Example: If save is made on Jan 11, 2005, the file name will be IMG20050111_0000.bmp. The number following “_” will be serial numbers, e.g. 0000, 0001.

16.6.4. Key lock Password Settings

Pressing button (4) on the Auxiliary Settings screen displays character entry screen and enables registration of key lock password. The key lock password is used to resume from the key lock condition. To lock the screen, press the icon on the upper right.



NOTE Please keep and hold your key lock password in secure place. Loss of your key lock passes causes en-unable you to release the lock.

NOTE To unlock, enter the password. If any password has been set, key lock can be unlocked without password.

A button upper right side of screen, by pressing the button you can lock the recorder and another pressing makes the lock release to Normal

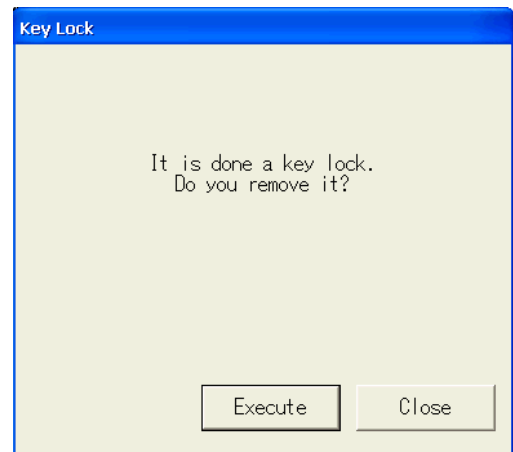
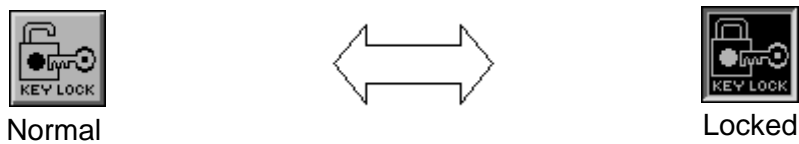

TIPS When you select "Disable Panel Keys", the Keys in operational panel such as "Input signal" "Replay" "Amp" "Recording Condition" "Trigger" "Display/Printing" "System" becomes inactivated.
 When you select "Disable Operational Panel Keys", all the Keys in operational panel becomes inactivated.

16.6.5. Mouse cursor

(5) in [Auxiliary Setting] is used to set ON or OFF for whether the mouse cursor is displayed or not. To make settings in RA2800A using the USB mouse, set to ON to indicate .

16.7. Maintenance

Press the System button on the Operation Panel and Maintenance. The following screen appears.

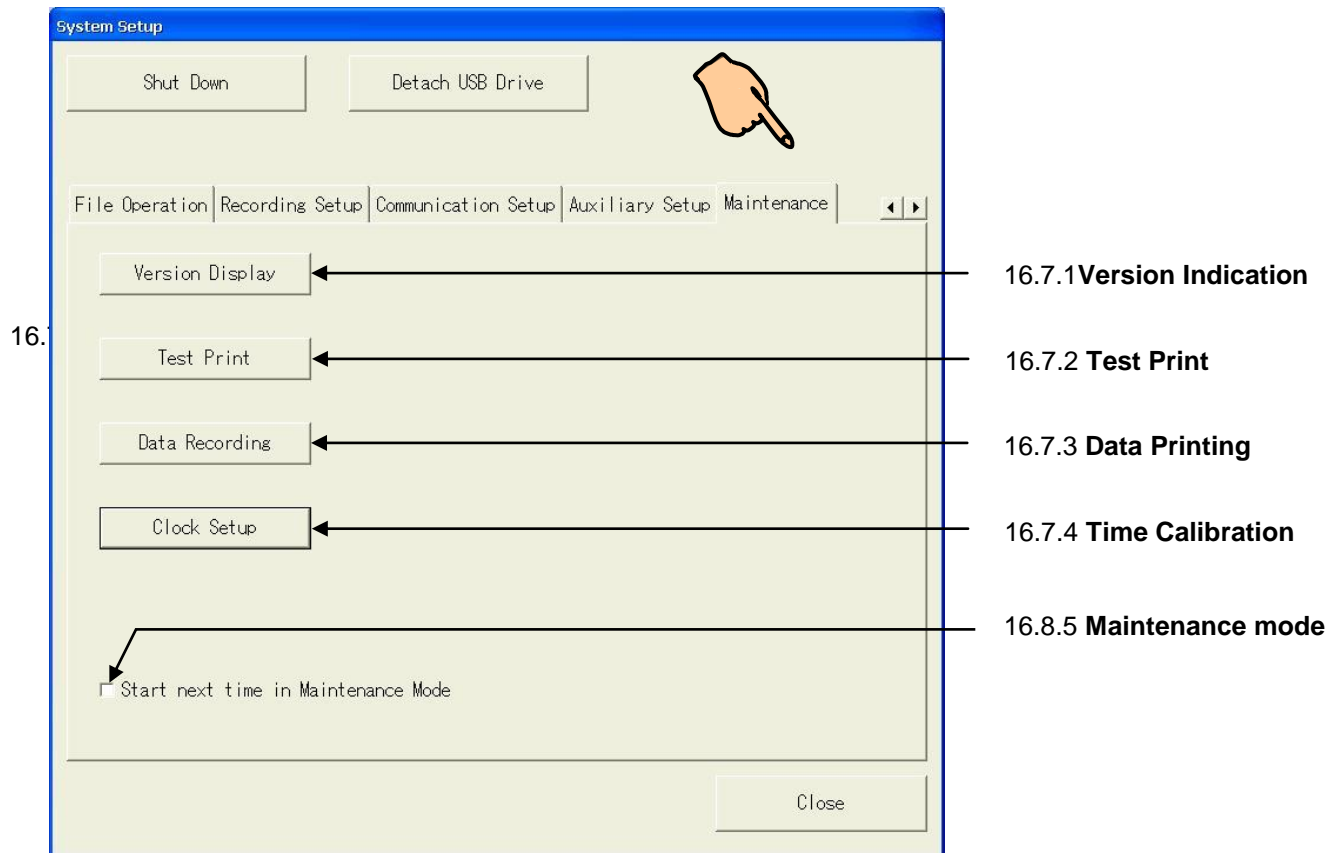

16.7.1. Version Indication

Product serial number and program version are indicated. Press the Version Display button on the Maintenance screen in System. The following screen appears.

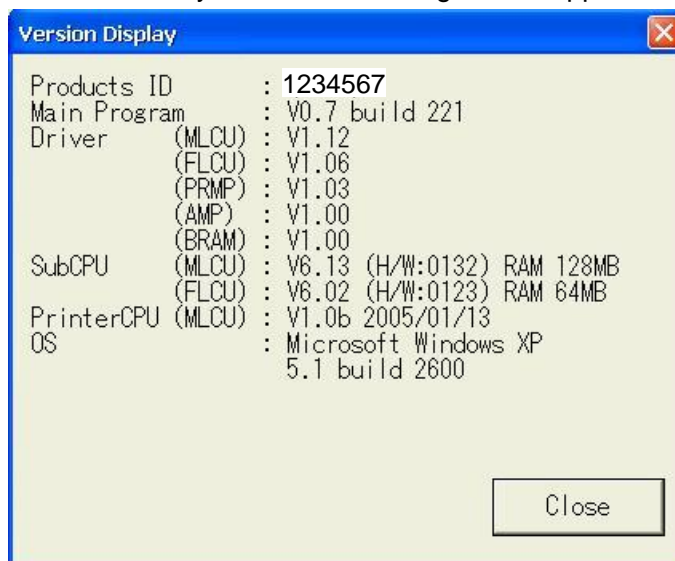

NOTE

If any accident happens during use, our staff may inquire of the version number.

16.7.2. Test Print

Test printing is made in order to check the printer printing quality. Pressing the Test Print button on the Maintenance screen in System opens the confirmation screen. Pressing “Execute” button starts the test print. To close, press “Cancel” button.

16.7.3. Data Printing

The measurement mode is set to Data Chart Print. In this mode, measured values are printed output in character strings.

16.7.4. Time Calibration

Internal watch is set. Press the Clock Setup button on the Auxiliary Settings screen in System. The following screen appears. Select window whose value should be set among windows of year, month, day, hour, time, minutes, and second. Enter a value and press OK button. Time can be set.

2005	YY	09	MM	01	DD
10	HH	16	Min	52	Sec
7	8	9			
4	5	6			
1	2	3			
0					

Execute Close

16.7.5. Maintenance mode

To start up with the Maintenance Mode, tick “Start up with the Maintenance Mode at next startup”, and then reboot. Then, the Maintenance Mode screen will appear. This Mode is used to upgrade the software version or perform other maintenance. As this setting may affect the system, use this Mode only when necessary.

17. How to Use Optional Units

17.1. Connecting optional units

⚠ WARNING

Please insert blank panel into empty slots when optional units are not connected in order to avoid electrical shock and to prevent damages to the recorder unit caused by interruptions of extraneous substances

⚠ CAUTION

Please turn the power off and unplug power strip from the recorder unit before connecting or disconnecting optional units. If optional units are connected or disconnected while the power of the recorder unit is ON, it may damage the optional unit and/or the recorder unit.

⚠ CAUTION

When exchanging units, do not touch internal parts, Internal parts may be damaged if touched by static body. Do not touch anything except for the panel when exchanging units. This may cause damages.

⚠ CAUTION

When connecting optional units, please be sure of top and bottom of the units and insert units in accordance with the guideline specified in input slot area. Tighten the screw with flat-head screwdriver after connecting optional units to the recorder unit. Connecting optional units requires a flat head screwdriver (screwdriver's end must be thinner than 0.65 mm).

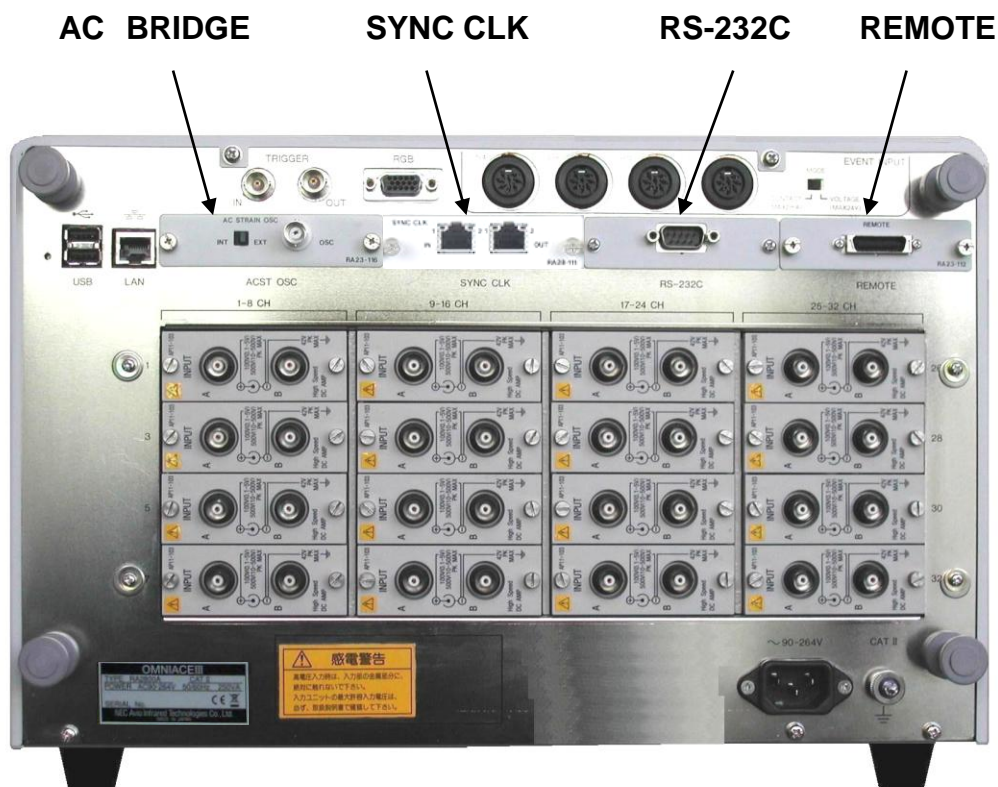

Above

17.2. Remote Unit (RA23-144)

17.2.1. Overview

Start/Stop of recording/printing, chart feed, marking, input/output for synchronized operations can be controlled by electric signals. Also, waveform printing synchronized to an external pulse signal (chart feed) and memory acquisition are possible. Other features include prevention of data file destructions by electric power failure and output of recorder unit error, etc. by using external input.



17.2.2. Connector/Pin Location

Connector Type : 8850-028-170-LD

Pin No	Signal name		Attached cable		
			Color of cable	Color of marks	Mark indication
A 1	+	SYNC IN	Amber	Red Black	I
A 2	-				
A 3	+	REC IN	Gray	Red Black	I
A 4	-				
A 5	+	MARK IN	White	Red Black	I
A 6	-				
A 7	+	FEED IN	Yellow	Red Black	I
A 8	-				
A 9	+	UPS DOWN	Pink	Red Black	I
A 10	-				
A 11	+	RESET IN	Orange	Red Black	I I
A 12	-				
A 13	+	EXT SAMPLE IN	Gray	Red Black	I I
A 14	-				
B 1	+	SYNC OUT	White	Red Black	I I
B 2	-				
B 3	+	REC OUT	Yellow	Red Black	I I
B 4	-				
B 5	+	MARK OUT	Pink	Red Black	I I
B 6	-				
B 7	+	FEED OUT	Amber	Red Black	I I
B 8	-				
B 9	+	ERROR OUT	Gray	Red Black	I I
B 10	-				
B 11	NO	POWER (Relay contact)	White	Red Black	I I
B 12	COM				
B 13	N.C	N.C COM	Yellow	Red Black	I I
B 14	-				

* **0-5V Input voltage**
LOW Level Less than 0.5 V
HIGH Level more than 4.5 V

* **0-5V output voltage**
LOW Level less than 1.0 V
(IOL = less than 5 mA)
HIGH Level more than 4.0 V
(IoH = less than 5 mA)

* **Relay contact**
Power Current 25 mA
Power Voltage less than 50 V

17.2.3. To Synchronize to External Pulse and Perform Waveform Chart Printing and Printing

Waveform recording, input monitor, filing acquisitions can be synchronized to external pulse. Instructions on how to connect remote terminals and how to set up the recorder unit are explained in the below.

(1) Connecting external input pulse signal

To print waveforms synchronized to external pulse signal, use the A1 pin (SYNC IN) of remote terminals. For input monitor and filing acquisitions, input external signal to synchronize in the A13 pin (EXT IN).

Paper Feeding Pitch Setting	SYNC OUT Pulse Output Frequency	Maximum Input Frequency
0.1 mm/pulse	(Paper feeding speed: mms)/0.1mm(Hz) Example: 50mm/s→500Hz, 1mm/min→approx.0.167Hz	500Hz

(2) Setting the recorder unit for external synchronization

- Set the measurement mode of the recorder unit to Pen Record mode.
- In the screen for speed/recording condition setting, set chart speed to External Synchronization.
[Monitor and acquisition speed] will also be set to external synchronization by this setup.

[8.1. Screen Operation]

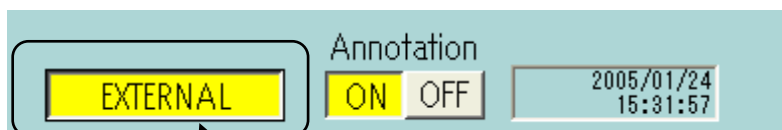

By pressing external button located in upper right of the Pen Recorder screen, the color will change and external synchronization will be set.

(3) Start recording

Once the signal connection of remote terminal is established and the recording speed is setup to external synchronal recording, it is now ready to perform external synchronized recordings. By pressing the Start button, external pulse will be synchronized and acquisitions and recording of waveforms will begin

TIPS

By inputting the same synchronized external signal into the A1 pin (SYN IN) of remote terminal and the A13 pin (EXT IN), waveform printing, display of input monitor, and recording can be performed simultaneously. This is valid under Pen Recorder, Multi, HD Recorder mode.

17.2.4. Memory Acquisition Using External Sampling

Described below are the instructions to perform acquisitions using external samples.

(1) Connect external input sampling signal

Connect the signal to use into the A13 (EXT IN) pin located in the backside of remote terminal. Please use the A14 pin for the common.

Recorder Mode	Maximum Input Frequency
Memory Recorder	10kHz
HDD Recorder	100Hz

(2) Set recorder unit to external synchronous setting

- Set measuring mode of the recorder unit to Memory Recorder mode.
- Set the Sampling rate to External Synchronization in detail setting for speed and condition screen.

Monitor/Recording Speed will be set to external synchronization by this setup.

 [9.2.2. Memory Recording Condition Setup Block].

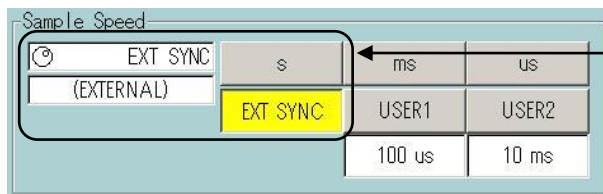

By pressing external synchronization button, the color will change and sample speed will be set as external synchronization.

(3) Start recording

When you setup signal connection for remote terminal and external synchronization in sampling speed setting, the recorder is ready. Pressing the “start” button here will synchronize the external pulse and acquisition to the memory will start.

17.2.5. Start/Stop recording (Start/Stop button)

It functions the same way as pressing the Start button on the panel and it starts acquisition. The A3 pin (REC IN) of remote terminal is controlled externally. For the common, use the A4 pin.

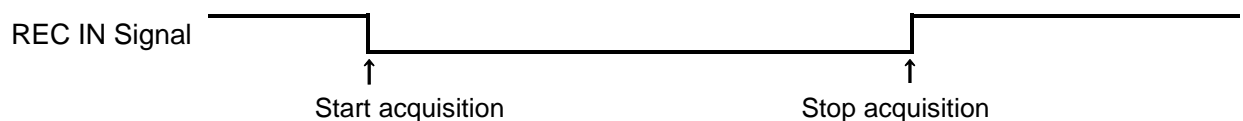

Acquisition will start when the falling edge of the signal is detected in the low level, and continues until the rising edge is detected, once rising edge is detected, acquisition will be stopped.

17.2.6. Chart Feed

It functions the same way as pressing the Feed button on the panel and it starts to blank feed recording chart paper. The A7 pin (FEED IN) is controlled externally. Please use the A8 pin as the common.

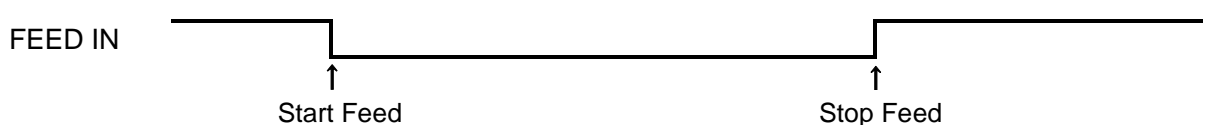

Feed will start when the falling edge of the signal is detected, and continues in low level until the rising edge is detected, once rising edge is detected, feed will be stopped.

17.2.7. Mark Printing

It functions the same way as pressing “mark printing” button on panel key and it prints marks. This becomes valid when the recorder unit is performing real time recording. The A5 pin (MARK IN) of remote terminal is controlled externally. Please use the A6 pin for the common.

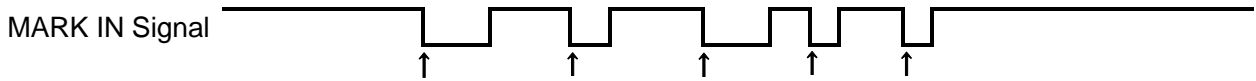

Mark is printed when the falling edge of signal is detected during real time recordings.

17.2.8. Protecting File Data (UPS DOWN)

This function prevents destructions of files, etc by external protection using uninterruptible power source in case of electrical power failure when accessing files during filing acquisitions of the recorder unit. The A9 pin (UPS DOWN) of remote terminal is controlled externally. Please use the A10 pin for the common.

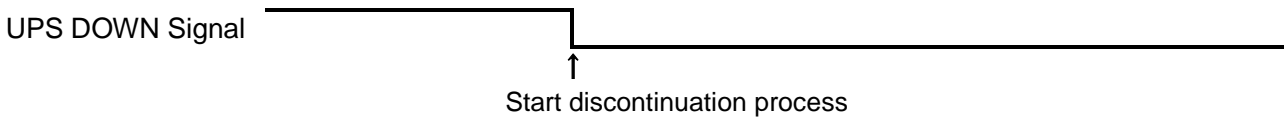

17.2.9. Monitoring errors on recording areas

Error signal is sent out when an error occurs in printing area (due to out of recording chart paper or thermal head abnormal temperature rise). Signal is sent out to the B9 pin (ERROR.OUT). For the common please use the B10.

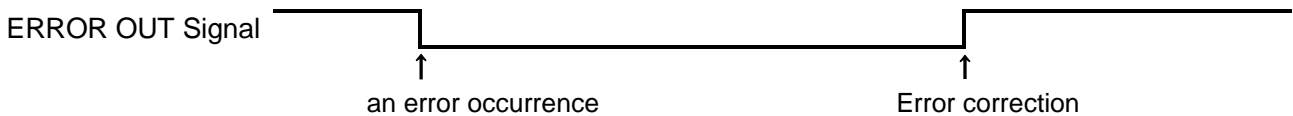

Low-level output will continue while an error is occurring. Output occurs independently with no relations to the acquisitions of the recorder unit.

17.2.10. Parallel Operation

This product can perform recording, chart feed, marking functions simultaneously by connecting remote terminals in parallel with multiple recorder units. Instructions below show how to connect (1) as a master recorder unit.

(1)

(2)

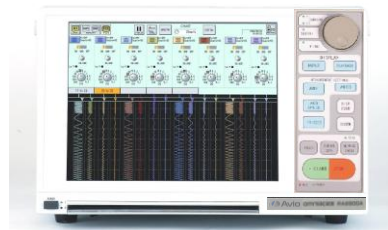
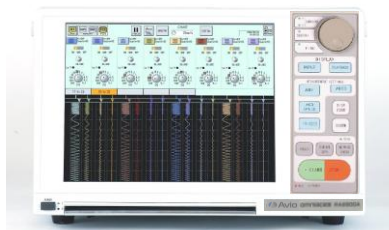

Name	Pin No.
REC OUT	(B3)
FEED OUT	(B7)
MARK OUT	(B5)
SYNC OUT	(B1)

Name	Pin No.
REC IN	(A3)
FEED IN	(A7)
MARK IN	(A5)
SYNC IN	(A1)

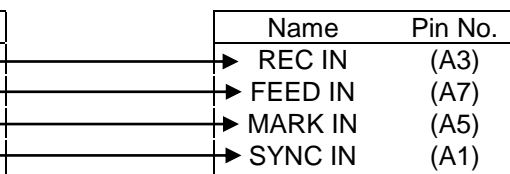

Through the connection above, panel operation on (1) controls recorder unit of (2) simultaneously.

※For Input/Output of trigger (TRIG.IN, OUT), please see page [13.2.2.External Trigger (TRIG IN).] [13.2.3. External Trigger Output (TRIG OUT)]

17.3. RS-232C Unit (RA23-142)

17.3.1. Names of each parts and their functions



Function	Connect to host computer and control Omni ace by command.																									
Specification	JIS X5101 (former C6361) compliant																									
	Data Format	Bit Serial																								
	Transfer speed	38400, 19200, 9600, 4800, and 2400[bps]																								
	Transfer format	asynchronous communication, total square transmission method																								
	Start bit	1[bit]																								
	Data bit	7,8[bit]																								
	Stop bit	1,2[bit]																								
	Parity bit	No Parity bit, EVEN, ODD																								
Mass	Approx. 50g																									
Pin Alignment	<table border="1"> <thead> <tr> <th>Pin No</th> <th>Name of signal</th> </tr> </thead> <tbody> <tr> <td>1</td> <td>CD(Carrier Detect)</td> </tr> <tr> <td>2</td> <td>RD (Received Data)</td> </tr> <tr> <td>3</td> <td>SD(Transmitted Data)</td> </tr> <tr> <td>4</td> <td>ER(Data Terminal Ready)</td> </tr> <tr> <td>5</td> <td>SG (Signal GND)</td> </tr> </tbody> </table>		Pin No	Name of signal	1	CD(Carrier Detect)	2	RD (Received Data)	3	SD(Transmitted Data)	4	ER(Data Terminal Ready)	5	SG (Signal GND)	<table border="1"> <thead> <tr> <th>Pin No</th> <th>Name of signal</th> </tr> </thead> <tbody> <tr> <td>6</td> <td>DR (Data set Ready)</td> </tr> <tr> <td>7</td> <td>RS(Request to Send)</td> </tr> <tr> <td>8</td> <td>CS (Clear to Send)</td> </tr> <tr> <td>9</td> <td>RI(Ring Indicator)</td> </tr> </tbody> </table>		Pin No	Name of signal	6	DR (Data set Ready)	7	RS(Request to Send)	8	CS (Clear to Send)	9	RI(Ring Indicator)
	Pin No	Name of signal																								
1	CD(Carrier Detect)																									
2	RD (Received Data)																									
3	SD(Transmitted Data)																									
4	ER(Data Terminal Ready)																									
5	SG (Signal GND)																									
Pin No	Name of signal																									
6	DR (Data set Ready)																									
7	RS(Request to Send)																									
8	CS (Clear to Send)																									
9	RI(Ring Indicator)																									

For Event Unit setup, please see page  [16.14. Communication Settings]

17.4. AC Bridge Excitation unit (RA23-143)

17.4.1. Names of each parts and their functions

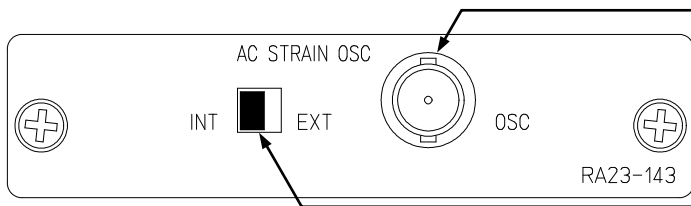

Connector
 INT : OSC power voltage output
 EXT : OSC power voltage input

Select Switch
 INT(Internal) : Mater (LED ON)
 (LED ON) : Slave (LED OFF)

Function	Bridge excitation when 2CH AC Strain Amp Unit (AP11-104) is in use.
Bridge excitation	2 Vrms, sin wave 5kHz
Synchronization	Possible to synchronize with other RA2800A internal AC Bridge Excitation Unit by using synchronization terminals. Master/Slave select switch attached.
Weight	Approx. 60g

17.4.2. Set up for Synchronization

To use multiple units of this product connected in parallel, please synchronize them with AC Bridge Excitation Unit (RA23-143) by following procedure described below. One unit becomes the master, and put OSC switch on AC Bridge Excitation Unit of master to INT, and put OSC switch of other slave machines to EXT.

◆ To synchronize two units

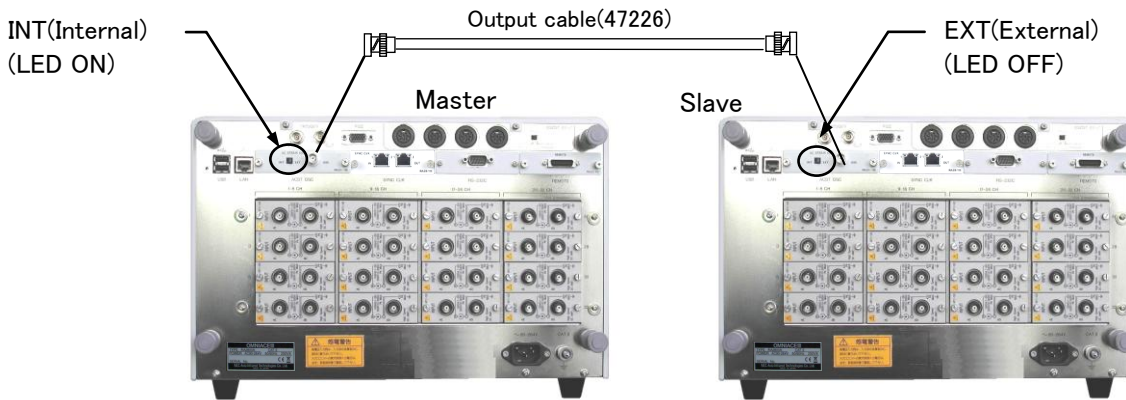

◆ To synchronize with more than 3 units- BNC Adaptor 0243-2118 is required.

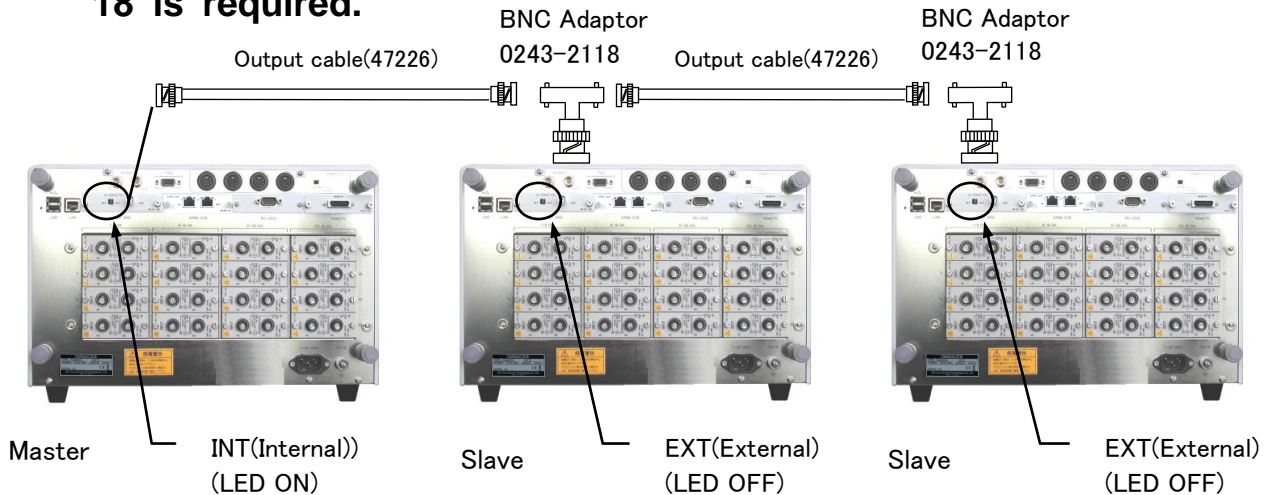

18. *Maintenance and Cleaning*

**WARNING**

This is precision equipment, so do not allow anyone other than a qualified technician from our company to open the main unit case.

18.1. Handling and Storing Recording Paper and Data

NOTE

Care is required when handling the thermo-sensitive paper used by this instrument.

The chemical reaction caused by using a thermal head to add heat to the underside of the recording paper used for the RA2800A allows distinct black on white recording. Take care to handle the recording part of this paper so as to avoid color leakage or discoloration of the white sheet through writing materials, chemicals, or the environment (etc.).

18.1.1 Storing the Recording Paper

- Do not store the paper in high temperature and humidity.
- Do not store the paper near heating fixtures.
- Store the paper in an environment with ambient temperature of 40°C or less, and do not store for a long period of time, as this may cause discoloration of the white sheet.
- Do not expose the paper to direct sunlight for long periods of time, especially in an unwrapped state, as this may cause discoloration of the white sheet. Take especial care, therefore, when using this instrument outside.

18.1.2 Caution for Handling and Storage of Recorded Data

- Do not store data in a hot or humid environment.
- Do not expose data to sunlight or strong light for a long period of time.
- Data may suffer from color leakage or white sheet discoloration due to heat, humidity, or light.
- Store data at 40°C and 80% RH or less.
- Data recorded in color will retain its color even if rubbed or exposed to water. However, the color will come off if rubbed strongly, so avoid doing so.
- The color on the recording paper will come off with volatile solvents such as alcohol and ester. It will not come off with oil-based solvents such as gin.
- If non-volatile solvents such as plastics are absorbed the color-recording capability will be reduced, causing color leakage in the recorded section.
- The recorded section may leak color if the thermo-sensitive paper is touched while not sufficiently dry.

18.2. Battery Backup

NOTE

- The setting values, date, and time of the recording are backed up for about three years.
- Recorded data cannot be backed up.
- If **【Save/Load of setups】** on the System screen is saved, these can be saved and read regardless of the battery. (Refer to Chapter 14 for details).

If not used for one month, the setting values, date, and time must be reset.

- Switch on the power
- Initialize the system
- Set the on-chip clock

Note that the battery is fully charged by applying power continually for about 12 hours.

18.3. Cleaning the Display

If the display screen becomes wet, either wipes it with a soft, dry cloth, or with gauze soaked in ethanol.

18.4. Cleaning and Preserving the Thermal Head

18.4.1. Cleaning

If recording for long periods of time, the heat dissipating part of this instrument's thermal head may become clogged with paper remains, etc. If the head is dirty, the quality of the printing and image reproduction will be reduced, so in this case the head will require cleaning.

1. Pull back stoppers located on both side of monitor and open a recording panel in recording area.  "3.2. Paper Loading".
2. Underneath of front recording panel, there is a thermal head. The actual thermo medium aligned 4.4 mm from tip of the thermal head. This alignment is to be cleaned.
3. Submerge cotton tipped applicator with ethanol.
As any contact of ethanol on recording paper makes color change, removing a recording paper to clean is recommended.
4. After the thermal head is dried, you can reattach the recording paper.

18.4.2. Life

The life of the thermal head is about 30 km (about 1000 rolls of YPS106 recording paper). The recording quality may drop if the head is used in excess of this amount. In this case the thermal head must be replaced (additional cost), so please contact one of our sales offices or distributors.

18.5. Platen Roller Storage

If the platen roller collects dust or other dirt, the thermal head may incur damage, or the quality of the printing or image reproduction may drop. When the roller shows signs of dirt, therefore, it must be cleaned carefully with gauze soaked in ethanol.

18.6. Dealing with Power Outages, etc.

If a power outage occurs, or the power cable is removed during recording, the status of the system following restoration of power will be as same status as [STOP] key on the operation panel is pressed. In this case, because the settings at power off are backed up, recording can be started again immediately.

If the auto start function has been set to ON, recording will commence automatically.

18.7. Cautions When Disposing of This Instrument

Be aware of the following when disposing of this instrument.

WARNING

This instrument employs a lithium secondary cell as the battery for back up.

Be sure to remove the lithium battery before disposing of this instrument.

The lithium battery should not be burned or broken open.

The lithium battery may explode if exposed to excessive heat. Moreover, the acid that may leak out if this battery is broken open is extremely dangerous and could cause serious injury. Tape the two potentials of the battery and dispose of it in the unburnable trash.

This instrument also employs an LCD screen.

Disposal of this battery or LCD may be subject to local regulations.

Be sure to follow the relevant regulations when disposing of this LCD.

19. Troubleshooting

19.1. Troubleshooting and Inspection

NOTE

If the recorder does not operate normally or need to be repaired after following the instructions for abnormal conditions, please contact our sales offices listed at the end of this manual.

Problem	Possible cause	Instruction	Refer to
No power supply. Nothing displayed on the screen	The power switch is turned off.	Turn on the power switch	Chapter 3
	The power cord is not properly connected.	After the power switch is turned off, connect the power cord correctly, and then turn on the switch again.	Chapter 3
	The fuse is blown.	The AC line input fuse for this unit cannot be replaced by the customer because this fuse is placed inside the main unit. Please contact us if the fuse may be blown.	End of this manual
The screen frozen	The screen is automatically turned off.	Touching any button turns it on.	Chapter 16
	Abnormal condition occurs in the system.	Turn off the power switch, and then turn it on again	Chapter 2
No reactions when pushing any button on the touch panel.	A recording operation is in progress in Memory mode or Multi-recorder mode. The start LED or the copy LED is on.	Push the stop button on the operation panel to stop measuring, and then push any button.	Chapter 2
No recording	There is no recording paper.	Insert recording paper.	Chapter 3
	The printer block is opened.	Close the cover of the printer block.	Chapter 3
	The temperature of the thermal head is abnormally high. (The environment temperature is over 40 degrees centigrade.)	Use the main body in a 5 to 40 degrees environment.	Chapter 20
Not start recording when pushing the start button.	The start trigger is on.	Turn off the start trigger.	Chapter 10
	Recording is set as an external synchronization recording	Recording is started only after inputting a pulse signal to a remote terminal. Therefore, input the signal, and then push the start button.	Chapter 17
	There is no chart paper.	Load a chart paper.	Chapter 3
Cannot save data to the selected media.	The media is not formatted.	Format the media.	Chapter 16
	The disk space is insufficient.	Erase unwanted files or use new media.	Chapter 16
	The media is write-protected.	Unprotect the media.	—
Not detected the media.	The media is not correctly formatted.	Format the media correctly.	Chapter 16
	The media is damaged.	-	—
Cannot specify and control operation through a communication interface.	The communication parameters are not specified correctly.	Specify addresses and communication parameters correctly.	Chapter 16

19.2. Frequently Asked Questions (Q&A)

This section covers frequently asked questions.

◆ Question List

Q 1: A copy of a screen can be saved into a file?	19-4
Q 2: Please inform details of the folder or directory that automatically generated after acquisition.	19-4
Q 3: What is the relation between the available acquisition time and the media (recording medium) space?	19-5
Q 4: A data cannot be saved in CSV format is not available with an insufficient media space message.	19-5
Q 5: A recording operation can be started when inputting a frequency exceeding external synchronization clock specifications (10 kHz), but is this operation available?	19-5
Q 6: After the speed of recoding paper feeding is externally synchronized, a monitor waveform is not displayed.	19-5
Q 7: Can another RA2800A playback the acquisition data?	19-6
Q 8: Can the setup environment file be used for other recorders?	19-6
Q 9: Extensions are different between the data stored with memory auto-save function and the data stored manually with Copy button in Output Specification.	19-6
Q 10: Can option units be added later?	19-6
Q 11: Are there any considerations upon using remote terminals?	19-6
Q 12: What is the "peak" format?	19-6
Q 13: How to set the recorder for unmanned operation?	19-7

Q 1: A copy of a screen can be saved into a file?

Answer	The copy can be saved in bitmap format.
Details	Select the sub setting tab by the System button and specify the folder in Save Screen Copy Destination. After this setting, you can push the Screen Copy button on the operation panel to save the copy to the specified folder in bitmap format.

Q 2: Please inform details of the folder or directory that automatically generated after acquisition.

Answer	The following folders are generated according to settings.
Details	<p>HD recorder mode (DNo.): \LOGFILE\ (USERNAME)\(Date Folder)\FREC_????</p> <p>Memory Recorder mode (DNo.): \LOGFILE \ (USERNAME)\(Date Folder)\ MEM_????</p> <p>Multi Recorder mode (DNo.): \LOGFILE (USERNAME)(Date Folder)\MIX_????\</p> <p>On this folder, FIL_???? .FPP (the file of real-time part. Its data format is peak) and MEM_???? .FSD (the files of memory block) are generated These are handled as a series of files and can be played in Zoom-in and Zoom-out replay screen.</p> <p>“LOGFILE” is a folder specified for a writing destination.</p>

Q 3: What is the relation between the available acquisition time and the media (recording medium) space?

Answer	The available time depends on Media space, a Data type, and a Channel Number.						
Details	The available time can be roughly estimated by the following formulas. Sample time: Acquisition length = (media space – 4KB) / (used channel numbers x 2) Peak time: Acquisition length = (media space – 4KB) / (used channel numbers x 4) <u>Maximum time of acquisition of 8Ch of 640MB data at sample time (acquisition length 39,999,750 data)</u>						
	Sampling speed	maximum recording time	[ms]	[s]	[min]	[h]	[day]
	200us	Approx. 2 hours	7,999,950	8,000.0	133.3	2.2	
	500us	Approx. 5 hours and 30 minutes.	19,999,875	19,999.9	333.3	5.6	
	1ms	Approx. 11 hours	39,999,750	39,999.8	666.7	11.1	
	2ms	Approx. 22 hours	79,999,500	79,999.5	1,333.3	22.2	
	5ms	Approx. 2 days and 7 hours	199,998,750	199,998.8	3,333.3	55.6	2.3
	10ms	Approx. 4 days and 15 hours	399,997,500	399,997.5	6,666.6	111.1	4.6
	20ms	Approx. 9 days and 15 hours	799,995,000	799,995.0	13,333.3	222.2	9.3
	50ms	Approx. 23 days	1,999,987,500	1,999,987.5	33,333.1	555.6	23.1
	100ms	Approx. 46 days	3,999,975,000	3,999,975.0	66,666.3	1,111.1	46.3
	200ms	Approx. 115 days	7,999,950,000	7,999,950.0	133,332.5	2,222.2	92.6
	500ms	Approx. 231 days	19,999,875,000	19,999,875.0	333,331.3	5,555.5	231.5
1s	Approx. 463 days	39,999,750,000	39,999,750.0	666,662.5	11,111.0	463.0	

Q 4: A data cannot be saved in CSV format is not available with an insufficient media space message.

Answer	The file size for saving in CSV format is about five times larger than in binary format.
Details	Use the media having enough space.

Q 5: Any waveform on the monitor is not displayed after setting the chart paper feed to external synchronization. Why?

Answer	A memory external synchronization is recorded by a 1 μ s gating internal clock with an external clock.
Details	A recording operation is available with the sampling rate up to about 1 μ s, but the 1 μ s maximum delay from an external clock develops. Therefore, inputting a fast clock may trigger a waveform distortion. The value of this specification is provided the value that can neglect the influence of a waveform distortion (1% or lower.)

Q 6: Display style of input monitor changes after changing the chart paper feed speed or recording speed. Why?

Answer	There are two kinds of display styles in input monitor, Scrolling style and Updating style.
Details	By 400 μ s (40 ms/div) sampling speed, it automatically displays scrolling style and over 400 μ s sampling speed, it automatically displays update style.

Q 7: Is it possible to replay the data recorded in the RA2800A in another RA2800A unit?

Answer	Another RA2800A can playback the data.
Details	However, if an amp unit for playback includes the old version of program, this unit cannot play the waveform of channels recorded by any additional later release type of unit.

Q 8: Is it possible to use setup environment file (.ENV) in other recorders?

Answer	This file can be used.
Details	It is possible when the version is the same. However, if the type of an implemented amp is different between this recorder and the other recorder, the other recorder applies its own default setting. Caution: If the environment file is created in a state of Using the communication unit such as RS-232C, this file cannot be used for the main unit without an appropriate unit.

Q 9: After purchased and added an amplifier unit, all these sep up values are initialized.

Answer	Any modification made in hardware calibration on Amplifier unit makes an additional amplifier unit initialized. Note: Any modification made on amplifier slot location, makes the amplifier initialized as well.
--------	---

Q 10: The extension is different between the data saved in the Memory Auto Save and manually saved data with the Copy button in Specify Output. Why?

Answer	The extension is .FSD when using Memory Save function with file tabs in the System button and auto-save function. On the other hand, the extension is .DRT when saving in Output Specification.
Details	A FSD file is dedicated to memory block and sample filing. A DRT file is used for the data of memory, sample filing and peak filing in a common format. The data such as cursor gap can be saved anytime while viewing a playback screen. This product can play both types of files.

Q 11: Can I add optional units later?

Answer	Except for the units that should be included at factory shipping, all of additional units can be implemented.
Details	Units which can be additionally included Remotes, RS-232Cs, and AC bridge power supply unit (optional)

Q 12: Are there some points to be noted when I use the remote terminal?

Answer	A start ON/OFF input terminal works same as the Start/Stop buttons.
Details	This terminal is available in any recording mode. However, the terminal always works after detecting rising or falling edges when voltage signal is on and off. Therefore, do not use the terminal that produces chattering (signal fluctuations) such as mechanical contacts.

Q 13: Clarify the "Peak"-type data?

Answer	One-point data is composed of both maximum and minimum values.
Details	Maximum and minimum points are detected at the maximum rate ($2\mu s$, $10\mu s$) of amp. This controls the number of data and allows completely catching changes in a signal. The following data is peak format. Extension of .FPP signifies the peak format. *The file, when a peak file is saved once again, with .DRT extension is also peak format. Real-time record to recording paper also uses peak format. No data is lost by changing the paper feeding speed.

Q 14: I'd like to make unmanned date measurement. How to set?

Answer	The Timer function of System allows this measurement.
Details	<p>The following is setting examples.</p> <p>Example 1: Recording from 12:00, Jan 7 to 10:00, Jan 8 in 2005</p> <p>Example 2: Recording from 9:00 to 10:00 every day</p> <p>Example 3: Recording for 10 minutes every three hours for a month from now on.</p> <p>Case of Example 1</p> <p>Start Timer</p> <p>Start date 2005/01/07/ 12:00</p> <p>End date 2005/01/08/ 10:00</p> <p>(A recording interval is not used)</p> <p>Case of Example 2</p> <p>Start Timer</p> <p>Start date **/**/**** 9:00</p> <p>Start date **/**/**** 10:00</p> <p>(A recording interval is not used)</p> <p>Case of Example 3</p> <p>Start Timer</p> <p>Start date 2005/01/05/12:00 (specify the time after the current time)</p> <p>End date 2005/02/06/12:00 (specify the time at the finish time of a measurement)</p> <p>Recording interval</p> <p>Recording starting interval: 2 hours.</p> <p>Recording operation interval: 10 minutes</p> <p>The Start button is automatically pushed at the time specified in the start timer, and then a recording operation is initiated. After starting, this operation works according to the specified interval and ending time</p> <p>Comment:</p> <p>In combination with the Trigger button function, Trigger detection can be waited during specified time.</p> <p>- If the Trigger mode is turned off in Memory Recorder mode, the memory auto-save takes effect during Stop. This allows automatically saving memory data based on the Stop time.</p> <p>Caution:</p> <p>Recording is not initiated with only Recording Interval Function ticked. To use interval, make sure to configure the Start Timer and tick.</p>

20. *Specifications*

20.1. Configuration

20.1.1. Model

This product is configured with the recorder unit, optional units, and a set of standard accessories.

Description	Model	Comment
OMNIACE III	RA2800A	If you wish to purchase the English version, specify this when making an order.

20.1.2. Main Unit/Amp Unit

Description		Configuration	Comment																																				
Main Unit	Main Unit (Operation Unit, Display Unit, Amp insertion Unit, and Control Unit)	1	USB port x 2 LAN port x 1																																				
	Recorder event	1	16 inputs																																				
	Built-in Printer	1																																					
	Power Supply Unit(100V AC to 240VAC)	1																																					
	Synchronization unit	Optional	RA28-132																																				
	Remote Unit	Optional	RA23-144																																				
	RS 232C Unit	Optional	RA23-142																																				
	AC Bridge Power Supply Unit	Optional	RA23-143																																				
Amp Unit	<table border="1"> <thead> <tr> <th>Unit Description</th> <th>Model</th> <th>Comment</th> </tr> </thead> <tbody> <tr> <td>2CH high resolution DC Amp Unit</td> <td>AP11-101</td> <td>HRDC</td> </tr> <tr> <td>2CH FFT Amp Unit</td> <td>AP11-102</td> <td>FFT</td> </tr> <tr> <td>2CH High-speed DC Amp Unit</td> <td>AP11-103</td> <td>HSDC</td> </tr> <tr> <td>2CH AC Strain Amp Unit</td> <td>AP11-104A</td> <td>ACST</td> </tr> <tr> <td>Event Amp Unit</td> <td>AP11-105</td> <td>EV</td> </tr> <tr> <td>2CH TC/DC Amp Unit</td> <td>AP11-106A</td> <td>TCDC</td> </tr> <tr> <td>TC/DC Amp Unit</td> <td>AP11-107</td> <td>TDC</td> </tr> <tr> <td>F/V Converter Unit</td> <td>AP11-108</td> <td>FV</td> </tr> <tr> <td>2CH Vibration/RMS Amp Unit</td> <td>AP11-109</td> <td>RMS</td> </tr> <tr> <td>2CH DC strain Amp Unit</td> <td>AP11-110</td> <td>DCST</td> </tr> <tr> <td>2CH Zero Suppression Amp Unit</td> <td>AP11-111</td> <td>HRZS</td> </tr> </tbody> </table>			Unit Description	Model	Comment	2CH high resolution DC Amp Unit	AP11-101	HRDC	2CH FFT Amp Unit	AP11-102	FFT	2CH High-speed DC Amp Unit	AP11-103	HSDC	2CH AC Strain Amp Unit	AP11-104A	ACST	Event Amp Unit	AP11-105	EV	2CH TC/DC Amp Unit	AP11-106A	TCDC	TC/DC Amp Unit	AP11-107	TDC	F/V Converter Unit	AP11-108	FV	2CH Vibration/RMS Amp Unit	AP11-109	RMS	2CH DC strain Amp Unit	AP11-110	DCST	2CH Zero Suppression Amp Unit	AP11-111	HRZS
	Unit Description	Model	Comment																																				
	2CH high resolution DC Amp Unit	AP11-101	HRDC																																				
	2CH FFT Amp Unit	AP11-102	FFT																																				
	2CH High-speed DC Amp Unit	AP11-103	HSDC																																				
	2CH AC Strain Amp Unit	AP11-104A	ACST																																				
	Event Amp Unit	AP11-105	EV																																				
	2CH TC/DC Amp Unit	AP11-106A	TCDC																																				
	TC/DC Amp Unit	AP11-107	TDC																																				
	F/V Converter Unit	AP11-108	FV																																				
	2CH Vibration/RMS Amp Unit	AP11-109	RMS																																				
	2CH DC strain Amp Unit	AP11-110	DCST																																				
2CH Zero Suppression Amp Unit	AP11-111	HRZS																																					

20.1.3. Standard options (Japanese version/100VAC system)

Description	Model	Rating	Quantity
AC Power Code	0311-5044	AC100V type 2.5 m	1
User's Manual	7001756-R01	For Mainframe	1
User's Manual	7006462-R01	For Amp Unit	1
Recording Paper Folder	8247-4310	One folder per each end of Recording paper	2
Recording Paper	0511-3167	A roll of paper 219.5 mm x 30 m	1
Amp Blank Panel	37137-7002-0000		16 (with equipped panels)
Interface Blank Panel	38410-2416-0000	*1 blank panel with 2 screws	3 (with equipped panels)
Interface Blank Panel	38410-2417-0000	*1 blank panel with 2 screws	1 (with equipped panels)

20.1.4. Options and Consumables

(1) Options for Event Amp Unit (AP11-105)

Description	Model	Comment
Logic IC Code	0311-5007	2 pieces per unit
IC Clip Code	0311-5008	4 pieces per a bag, 2 bags per unit
Alligator Clip Code	0311-5009	4 pieces per a bag, 2 bags per unit

(2) Accessory for the remote unit (RA23-144)

Description	Model	Comment
Remote Cable	00311-5251-0000	1 piece per unit

(3) Chart printing Paper

Description	Model	Rating
Recording Paper	YPS106	A roll of paper 219.5 mm x 30 m, Five rolls per box
Recording Paper	YPS108	A roll of paper 219.5 mm x 30 m, Five rolls per box Paper with tear-off strip, 150 mm pitch Remaining indicator print 300 mm 99 to 01 pitch
Recording Paper	YPS112	Fold-up paper 219.55 x 200 mm, fold width 300 mm Remaining indicator print (page) 669-000
Chart printing paper	YPS114	Roll paper 219.5 mm x 100 m 2 rolls per box

20.1.5. Other Options

Description	Model	Comment
Dedicated Transport Box	RA28-113	
Dust Cover	RA28-114	Plastic dust cover
Hand Truck	RA28-116	
Take-up Equipment	RA28-119	
Storage case	RA28-115	
Fixing bracket for racks	RA28-117	JIS rack
Fixing bracket for racks	RA28-118	EIJ rack

20.1.6. Special Software

Name	Model	Note
Unifizer	NS3100-P01	This software enables connecting a PC to RA2800A via LAN cable for remote control such as data acquisition, various setups, and record starting.

20.2. Basic Specifications

20.2.1. Recorder Unit Specifications

Input part	Slot Number	16 (mixing different amp units are available)												
Recorder event	Number	16												
Display Part	Display Equipment	12.1 inches TFT color LCD												
	Available Display Area	245.88mm x 184.3mm (1024 x 768 dots)												
Internal memory		Acquisition data capacity: 1MW/Ch												
Drive	Internal HDD Drive	40GB (including approx 5GB of system area)												
	External Drive (USB Connection 1/2)	USB Memory (The USB memory with a security function cannot be used.)												
I/O Port	RS-232C	Compliant with JIS X5101 (Optional)												
	LAN	IEEE802.3U 100/10BASE-T												
Recording Part	Recording Type and Recording width	Heat-sensitive recording by thermal head, Recording width 216 mm												
	Recording data	Waveform records, X-Y records, screenshots and so on												
	Recording Paper	Roll paper 219.5mm x 30m (YPS106), 219.5mmx100m (YPS114) Fold-up paper (219.5 mm x 200 m) is available by using adaptor.												
	Waveform Recording Density	<table border="1"> <thead> <tr> <th></th> <th colspan="2">[dots/mm]</th> </tr> <tr> <th></th> <th>Voltage Axis</th> <th>Time Axis</th> </tr> </thead> <tbody> <tr> <td>Chart Record</td> <td>8</td> <td>10 to 80</td> </tr> <tr> <td>Playback Copy</td> <td>8</td> <td>10</td> </tr> </tbody> </table>			[dots/mm]			Voltage Axis	Time Axis	Chart Record	8	10 to 80	Playback Copy	8
	[dots/mm]													
	Voltage Axis	Time Axis												
Chart Record	8	10 to 80												
Playback Copy	8	10												
Power Supply	Rating Line Voltage	100 to 240 VAC												
	Line Voltage Fluctuations Tolerance	90 to 264 VAC												
	Rating Power Supply Frequency	50/60 Hz												
	Power Supply Frequency Tolerance	47 to 63 Hz												
	Withstanding Voltage	Power Supply Input Terminal – between groundings 1.5k VAC one minute												
	Insulation Resistance	Power Supply Input Terminal – between groundings 500 VDC more than 100M Ohms												
	Power Consumption	Approx. 350 VA max. <u>Approx. 170 VA during standby (When 16 pieces of 2-CH high-speed DC amps are built in.)</u>												
Fuse	Maximum Rating Voltage	250 V												
	Maximum Rating Current	6.3A												
	Type	Time-lug												
*The fuse for this unit cannot be replaced with the customer because this fuse is placed inside the main unit. Please contact our branches or sales offices if the fuse may be blown.														
Environment	Usage Environment	<p>Temperature: 5 to 40°C Humidity: 35-80%RH (without condensation) Location of use: indoor use Altitude: Not higher than 2000 m Resistance to vibration: There is not a malfunction according to the following examination. (excluding when at paper output)</p> <p>(1) The durability examination at random vibration</p> <table border="1"> <thead> <tr> <th>Frequency</th> <th>FM</th> <th>PSD</th> </tr> </thead> <tbody> <tr> <td>5Hz</td> <td></td> <td>0.00128g²/Hz</td> </tr> <tr> <td>200Hz</td> <td></td> <td>0.00128g²/Hz</td> </tr> </tbody> </table> <p>Vibration Time 1 hour Direction Top & Bottom, Front & Rear, Left & Right</p> <p>(2) The durability examination at sine wave vibration</p> <p>Frequency 5 to 40 Hz Level 0.5G (Examination repeated only for top and bottom 0.25.) Sweep Time 3 minutes Vibration Time 0.5 hours Direction Top to Bottom, Front to Rear, Left to Right</p>		Frequency	FM	PSD	5Hz		0.00128g ² /Hz	200Hz		0.00128g ² /Hz		
Frequency	FM	PSD												
5Hz		0.00128g ² /Hz												
200Hz		0.00128g ² /Hz												

	Save Environment	Temperature: -10 to 60°C Humidity: 35-85%RH (without condensation)
Apperance/ Weight	Dimension	400 ± 3 (W) × 270 ± 3 (H) × 380 ± 3 (D) mm (including rubber legs) Excluding protrusion (knurl screws in an Amp part and a jog dial)
	Weight	Approx. 16.4 kg Main body only (excluding Amps and options) Approx. 18.8 kg Option and 12 units of AP11-103 Amps are installed.
Others	Built-in Clock	±30 seconds error per month (ambient temperature 25 degrees centigrade)
	Backup	A clock and setting information are backed up by built-in battery. (manganese dioxide primary battery) Battery life: approx. 3 years (ambient temperature 25 degrees centigrade)

20.2.2. Recording Function

The followings are common functions of printing on recording papers regardless of a recording mode.

Function	waveform	X-Y	Explanation
Scale Print	√	√	Scales are automatically adjusted based on sensitivity and base line positions, and then printing is available at the end of recording.
Trigger Information	√	-	After printing a trigger point as the arrow mark (↓), the occurrence date and time of trigger can be printed together.
Data Information	√	√	Records can be printed with information such as recording mode, measuring date and starting time, data No. , trigger conditions (trigger points and trigger date and time), sampling speed, paper feeding speed, and time axis.
User Page annotation	√	-	An annotation is printed on records. Maximum 64 characters x 108 rows can be specified.
Channel Annotation	√	√	Channel information is printed on records.
Signal Name	√	-	An annotation per signal is printed before waveform records. Maximum 31 characters can be specified.
Measurement Information	√	-	An annotation is printed before waveform information. Maximum 64 characters x 108 rows can be specified.

20.2.3. Amp Unit Function

The followings are functions of recording and monitoring related to an amp unit.

Function	Record	Monitor	Explanation
Physical Quantity Conversion	√	√	The waveform of an amp unit and full scale of display output can be changed, and Input signals can be configured in physical quantity or an arbitrary unit.
Wide Scale	√	√	Full scale can be changed to display or record the all range possible to be input at standard sensitivity.
Channel Discrimination	√	-	Channel No. can be printed near waveform records.
Signal Name	√	√	Any input character can be printed. Maximum 8 characters x 1 row.
Base Line Setting	√	-	The base line thickness of a waveform record can be specified per channel.
Zero Position	√	√	Zero position can be specified at 5%, 10%, or 0.05% step of full scale
Recording limitation of event amp	√	√	A maximum of 16 units of event amps can be installed. However, recording can be done in up to 8 units at a time. When using 8 or more units, set to OFF on the waveform printing setup in each unit.

20.2.4. Trigger Function

(1) Basic Function

Trigger Source	Internal Trigger	Trigger by input signals from each amp.	
	Manual Trigger	Trigger by manual trigger key on the operation panel	
	External Trigger	Trigger by trigger inputs	
Pre-trigger	From 0 to 100%, 1% step		
Trigger Filter	From 1 to 65534 samples		
Trigger Operation	Once, Repeat, Endless		
Trigger Mode	Four types: OR, AND, Window, and OFF ON/OFF switching of Monitor synchronize available with TRIG/SYNC key		
	Trigger Mode	Source Channel	
	OR	Any Channel can be selected from all channels	Generating conditions of triggers from input signals
	AND		When a condition is met in any channel.
	WINDOW		When all conditions are met in all selected channels.
OFF	When a signal level changes out of range or into range of maximum / minimum trigger levels.		
	-	Any Trigger is not used.	
	*Manual triggers and External triggers may be generated regardless of a trigger mode.		
	*An event amp unit cannot be specified as a source channel of Windows trigger.		
Trigger Output	When a trigger condition is met, the TTL level of voltage signal (Active Low, Pulse width approx, 10ms) is output.		

(2) Trigger Function of Analog System Amp Unit

Trigger Detection Accuracy	±2%/FS	
Trigger Level	This level is specified by a physical value.	
Trigger slope	Different depends on a trigger mode.	
	Trigger Mode	Slope
	OR	Rising, Falling
	AND	Rising, Falling
	WINDOW	IN/OUT to the specified range

(3) Trigger Function of Event Amp

State setting	H, L, or OFF in every input from 1 to 8.	
State Mode	OR, AND	
	State Mode	Achieving conditions of channel triggers
	OR	When any input state equals to a specified trigger state.
	AND	When All input states equal to a specified trigger state.
	*This mode cannot be specified in the source channel of a WINDOW trigger.	
	*After a condition of channel trigger is achieved, the next trigger is generated until the condition is not achieved again.	

20.2.5. File Function

(1) Available Drive

Drive Name	Drive No.	Available Media (Drive)
Built-in HDD	D fixed	40GB (including approx 5GB of system area)
External (USB) Connecting Drive	From E	USB memory *Only recommended products are available.

*Only recommended drives and media are supported.

(2) Filing Recording Function

Measuring data can be sent to a built-in HDD drive in real-time to be saved as a file.

Common Function Name	Function Details
Automatically creating a folder specified by a user	If multiple users use a recorder body, the folder specified by each user is automatically created at the time of recording to manage user's data.
Automatically creating folder specified per day	The folder per day can be created to manage filing data.
Auto Name	A File or a Folder can be saved with the name of any four characters plus automatically updated four-digit number updated *If multiple files are saved at one recording, a folder is created.

(3) File Operation

operating devices	Built-in HDD drive and External drive (USB connection)
Format	Logical/Physical format in NTFS is available
Saving Environment File	Setting and annotation information can be saved as four files.
Saving Text File	Text information of signal names and user's annotation can be saved. This information can be saved as a file in the start up screen displayed when the power supply is on.
Saving Memory Data	Acquired memory data can be saved in binary or CSV format.
Creating Folder	Any name of folder can be created.
Deleting	Files and folders can be deleted.
Importing File	An environmental file (ENV) and an annotation text (TXT) can be imported.

20.2.6. Monitor displaying and setting function

Use the Operation Panel (including jog dial) and the touch panel to configure various settings

(1) Input Setting Screen

Use this screen to configure the waveform of input signals and input setting.

Digital values and cursor values of an input signal can be displayed.

Operation Panel	Configuration
INPUT SIGNAL	Display waveforms on the whole screen.
Amp	Configure amp settings and physical quantity conversion of an input signal.
Trigger	Configure the settings of trigger modes, trigger conditions, recording operations, pre-triggers, and trigger filters.
RECORD CONDITION	Configure the settings about recording such as speed.
View/Record	Configure the settings such as scale views, signal names, grids, waveform segmentations.

Operation Button	Configuration
FREEZE	Monitor Displaying can be paused.
TRIG SYNC	Monitor Displaying synchronized a trigger detection is available.
MONITOR	Configure the speed of input monitor.
DIGITAL	Display input signals in digital form.
KEY LOCK	Cancel the Key Lock setting.

(2) Playback Setting Screen

Use this screen to select the main unit's memory and the filing data, configure physical quantity conversion setting, display playback waveforms, and so on.

Screen Select Button	Configuration
Selecting Data	Select the data for playback.
Output Specification	Configure where to output and the output condition.
Copy	Copy the range specified by an output setting.
Digital Display	Configure the digital value for displaying.
Signal Setting	Configure the amp setting of a channel of which data is played back.
Jump	Configure an arbitrary position to move the range of monitor displaying.
Time Axis	Configure narrowing/extending of waveform time axis.
X-Y	Display data in X-Y format.
KEY LOCK	Configure ON/OFF of a Key Lock

(3) Scrolling direction

The scrolling directions of input and playback signals can be set to either vertical (top to bottom) or horizontal (right to left) directions.

Screen layouts such as amp, trigger, or record setups vary depending on the scrolling direction.

20.2.7. Monitor Output

(1) XGA Monitor Output

The same screen as the display unit is output to the XGA monitor. (Analog RGB, 1024 × 768 dots)

(2) Output connector

Pin No	Signal	Pin No	Signal	Pin No	Signal
1	R	6	0V	11	N. C
2	G	7	0V	12	DDDA-R
3	B	8	0V	13	HSYC
4	N. C	9	N. C	14	VSYC
5	0V	10	0V	15	DDCK-R

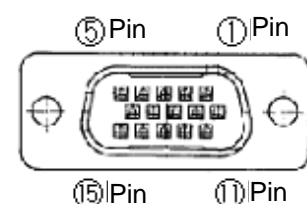

20.3. Specifications by each measurement mode

20.3.1. Memory Recorder mode

Use this mode to acquire measuring data of input signals to the main body's memory. This mode is mainly used for measuring high-speed phenomenon based on the trigger. After the recording, the data can be displayed on a playback monitor and be copied.

(1) Memory Acquisition

recording speed	Configure by the sampling speed (period). 2 to 999 μ s, 1 to 998 ms, and 1 to 100 s. can 2 to 999 μ s, 1 to 999 ms, and 1 to 100 s can be configured for user 1 and user 2. *Acquisition by external clock synchronization (Remote Unit: due to the option of an external sample input)	
Time Axis	0.01%	
Memory Space	1 MW/CH	
Block division	1 to 128 Block	
Acquisition Operation	Push the start key on the operation panel to start. (Starting with time trigger is also available) Once, Repeat, and Endless settings are available.	
	Acquisition Method	Acquisition Operation
	Once	Measurement is made once and is finished.
	Repeat	A measurement is repeated the same times as the number of memory block and is finished.
	Endless	A measurement is repeated until it is stopped.
	*For endless, the existing data is overwritten.	
Copy Range	Specified Range, Based on Trigger	
	Copy Range	Copy Operation
	Trigger center	Data amount from 1 to 100% of the trigger center is copied.

(2) Auto Copy Printing

After recording of memory data into a main unit, the data is copied or output to a file. (ON/OFF is available)

Copy Range	Based on Trigger to copy to a recording paper with 1% to 100% of data.
Where to output	Output to a recording paper or a file.
Data Format for File Output	Based on Trigger to output to a file with 1% to 100% of data. *CSV is a comma or tab delimited text format that can be used in spreadsheet software. *File extension FSD (binary), CSV (CSV)
Acquisition Drive	Built-in HDD drive or External Drive (USB supported)

20.3.2. HD Recorder Mode

Use this mode to acquire measuring data of input signals directly to a built-in HDD.

Acquisition method can be configured sample or peak.

Acquisition Operation	Push Start key on the operation panel to start. (Starting with built-in timer is also available)
Acquisition Drive	Built-in HDD drive
recording speed	2 to 999 μ s, 1 to 999 ms, and 1 to 100 s ; User1,User2. *The recording speed of over 10 μ s needs conditions: 2 μ s at 1Ch and 10 μ s at 2 to 16 Ch.
Time Axis	0.01%
Acquisition method	Sample (Acquiring data in every recording speed to media) Peak (Acquiring maximum and minimum values in every recording interval during 2 μ s sampling to media.)
Waveform Recording ON/OFF	While acquiring data, recording waveform on recording papers is available. Recording can be configured aside form recording.
Data Output Format	Only binary

20.3.3.Pen Recorder Mode

Use this mode to record measuring data with the image of a pen recorder.

Paper Feeding Speed	1, 5, 10, 20, 50 mm/s 1, 5, 10, 20, 50, 100 mm/min User setting 1, User setting 2: Any speed from 1 to 50 mm/s and 1 to 100 mm/min can be specified. The waveform printing by the external clock synchronization is also possible. (by external pulse input of a remote unit)
Time Axis	Within $\pm 0.01\%$ (Error of time and printed grid, at ordinary temperatures)
Paper Feeding Accuracy	Within $\pm 2\%$
Time Axis	10 mm/div
Interpolation	Available
Data recording	Peak detection by 2 μ s sampling
Time Axis dot pitch	10 dots/mm
Amplitude Axis dot pitch	8 dots/mm

20.3.4. X-Y Recorder Mode

Use this mode to output an X-Y image on a screen/recording paper. HDD recording is also available at the same time.

The recording method can be configured sample.

Setting Channel	Any 1Ch in the X axis and 3Ch in the Y axis can be specified.
Recording Density	At the time of output on recording papers: 1600 x 1600 dots
Interpolation	Available (line)/Not available (dot)
Sample Speed	1 to 1000 ms

*An Even Amp Unit is not available.

20.3.5. Multi Recorder mode

(1) Memory Recording

Recording speed	The speed is set with sampling cycle. 2 to 995 μ s, 1 to 999 ms, and 1 to 100 s. 2 to 999 μ s, 1 to 999 ms, 1 to 100 s can be set for Users 1 and 2. * Recording started by external clock synchronization (External sampling input from remote unit)	
Memory size	1M data/CH	
Block segmentation	1, 2, 4, 8, 16, 32, 64, and 128 segmentations	
Recording operation	Starting with the Start button on the operation panel. Chose a mode from among Once, Repeat, and Endless.	
	Recording mode	Recording operation
	Once	Ends after recording once
	Repeat	Ends after recording the number of times equivalent to the number of memory block
Endless	Continuously records until the operation is stopped	
* The Endless mode overwrites new data over old data.		

(2) HD Recording

Recording operation	Recording operation starts with the Start button on the operation panel. Starting with a time trigger is also possible.
Recording drive	Internal HDD drive or external drive (USB supported)
Recording speed	2to 995 μ s, 1 to 999 ms, and 1 to 100 s ; User1,User2. * High-speed recording may not be available depending on the drive to be recorded and channels to be recorded.
Recording method	Peaks (Recording max. and min. values among sampled values by 2 μ s in HDD)
Waveform printing ON/OFF	Waveform printing on chart paper with recording data is available. The chart feed speed and the monitor can be either independent or synchronized with recording speed.
Data output format	Only binary Peak filing data

(3) Pen Recording

It is possible to print input signals directly on the chart paper.

Paper Feeding Speed	1 to 50mm/s, 1 to 100mm/min. Waveform printing synchronized with external clock, i.e. external sampling input in the remote unit, is possible.
Time Axis	Within $\pm 0.01\%$ (Error of time and printed grid, at ordinary temperatures)
Paper Feeding Accuracy	Within $\pm 2\%$
Time Axis	10mm/div
Interpolation	Provided
Data recording	Peak detection by 2 μ s sampling
Time Axis dot pitch	10 dots/mm
Amplitude Axis dot pitch	8 dots/mm

20.4. Recorder Event

Function	In the recorder event, the assessments of voltage input (H and L) and contact input levels (H: short, L: open) are possible. Connection to up to 16 inputs is available.																																																																																			
Appropriate Cable	Input cable for event (0031-5001): 1.5 m (Cable tips are being cut off) Input extension cable for event (0311-5005): 1.5 m Clip cable for logic IC(0311-5007): 1.5 m (EI connector, 4 ch) Cables for IC clip(0311-5008): (EI connector : IC clip- 4 clips/Pair) Cables for wiring clip(0311-5009): (EI connector : Wiring clip-4 clips/Pair) * Varieties of event Cables are available for optional order.																																																																																			
Standard	<table border="1"> <tr> <td rowspan="3">Voltage input</td> <td>range of input voltage</td> <td colspan="2">0 - +24 V</td> </tr> <tr> <td>detection levels</td> <td colspan="2">H-level: more than 2.5V approximately L-level: less than 0.5 V approximately</td> </tr> <tr> <td>input current</td> <td colspan="2">no more than 1 ΩA</td> </tr> <tr> <td rowspan="3">Contact input</td> <td>detection levels</td> <td colspan="2">open: no less than 2 kΩ short: no more than 250 Ω</td> </tr> <tr> <td>load current</td> <td colspan="2">2 mA (MAX)</td> </tr> </table>				Voltage input	range of input voltage	0 - +24 V		detection levels	H-level: more than 2.5V approximately L-level: less than 0.5 V approximately		input current	no more than 1 Ω A		Contact input	detection levels	open: no less than 2 k Ω short: no more than 250 Ω		load current	2 mA (MAX)																																																																
Voltage input	range of input voltage	0 - +24 V																																																																																		
	detection levels	H-level: more than 2.5V approximately L-level: less than 0.5 V approximately																																																																																		
	input current	no more than 1 Ω A																																																																																		
Contact input	detection levels	open: no less than 2 k Ω short: no more than 250 Ω																																																																																		
	load current	2 mA (MAX)																																																																																		
	Connector	Round DIN connector 8P (plug view from plug-in side) <div style="text-align: center;"> </div>																																																																																		
Pin alignment	<table border="1"> <thead> <tr> <th colspan="2">Connector 1 - 4</th> </tr> <tr> <th>Pin No</th> <th>Signal assignment</th> </tr> </thead> <tbody> <tr><td>1</td><td>ch 1 input</td></tr> <tr><td>2</td><td>ch 2 input</td></tr> <tr><td>3</td><td>ch 3 input</td></tr> <tr><td>4</td><td>ch 4 input</td></tr> <tr><td>5</td><td>ground</td></tr> <tr><td>6</td><td>+15 V output</td></tr> <tr><td>7</td><td>not connected</td></tr> <tr><td>8</td><td>not connected</td></tr> </tbody> </table>	Connector 1 - 4		Pin No	Signal assignment	1	ch 1 input	2	ch 2 input	3	ch 3 input	4	ch 4 input	5	ground	6	+15 V output	7	not connected	8	not connected	<table border="1"> <thead> <tr> <th colspan="2">Connector 5 – 8</th> </tr> <tr> <th>Pin No</th> <th>Signal assignment</th> </tr> </thead> <tbody> <tr><td>1</td><td>ch 5 input</td></tr> <tr><td>2</td><td>ch 6 input</td></tr> <tr><td>3</td><td>ch 7 input</td></tr> <tr><td>4</td><td>ch 8 input</td></tr> <tr><td>5</td><td>ground</td></tr> <tr><td>6</td><td>+15 V output</td></tr> <tr><td>7</td><td>not connected</td></tr> <tr><td>8</td><td>not connected</td></tr> </tbody> </table>	Connector 5 – 8		Pin No	Signal assignment	1	ch 5 input	2	ch 6 input	3	ch 7 input	4	ch 8 input	5	ground	6	+15 V output	7	not connected	8	not connected	<table border="1"> <thead> <tr> <th colspan="2">Connector 9 – 12</th> </tr> <tr> <th>Pin No</th> <th>Signal assignment</th> </tr> </thead> <tbody> <tr><td>1</td><td>ch 9 input</td></tr> <tr><td>2</td><td>ch 10 input</td></tr> <tr><td>3</td><td>ch 11 input</td></tr> <tr><td>4</td><td>ch 12 input</td></tr> <tr><td>5</td><td>ground</td></tr> <tr><td>6</td><td>+15 V output</td></tr> <tr><td>7</td><td>not connected</td></tr> <tr><td>8</td><td>not connected</td></tr> </tbody> </table>	Connector 9 – 12		Pin No	Signal assignment	1	ch 9 input	2	ch 10 input	3	ch 11 input	4	ch 12 input	5	ground	6	+15 V output	7	not connected	8	not connected	<table border="1"> <thead> <tr> <th colspan="2">Connector 13 - 16</th> </tr> <tr> <th>Pin No</th> <th>Signal assignment</th> </tr> </thead> <tbody> <tr><td>1</td><td>ch 13 input</td></tr> <tr><td>2</td><td>ch 14 input</td></tr> <tr><td>3</td><td>ch 15 input</td></tr> <tr><td>4</td><td>ch 16 input</td></tr> <tr><td>5</td><td>ground</td></tr> <tr><td>6</td><td>+15 V output</td></tr> <tr><td>7</td><td>not connected</td></tr> <tr><td>8</td><td>not connected</td></tr> </tbody> </table>	Connector 13 - 16		Pin No	Signal assignment	1	ch 13 input	2	ch 14 input	3	ch 15 input	4	ch 16 input	5	ground	6	+15 V output	7	not connected	8	not connected
Connector 1 - 4																																																																																				
Pin No	Signal assignment																																																																																			
1	ch 1 input																																																																																			
2	ch 2 input																																																																																			
3	ch 3 input																																																																																			
4	ch 4 input																																																																																			
5	ground																																																																																			
6	+15 V output																																																																																			
7	not connected																																																																																			
8	not connected																																																																																			
Connector 5 – 8																																																																																				
Pin No	Signal assignment																																																																																			
1	ch 5 input																																																																																			
2	ch 6 input																																																																																			
3	ch 7 input																																																																																			
4	ch 8 input																																																																																			
5	ground																																																																																			
6	+15 V output																																																																																			
7	not connected																																																																																			
8	not connected																																																																																			
Connector 9 – 12																																																																																				
Pin No	Signal assignment																																																																																			
1	ch 9 input																																																																																			
2	ch 10 input																																																																																			
3	ch 11 input																																																																																			
4	ch 12 input																																																																																			
5	ground																																																																																			
6	+15 V output																																																																																			
7	not connected																																																																																			
8	not connected																																																																																			
Connector 13 - 16																																																																																				
Pin No	Signal assignment																																																																																			
1	ch 13 input																																																																																			
2	ch 14 input																																																																																			
3	ch 15 input																																																																																			
4	ch 16 input																																																																																			
5	ground																																																																																			
6	+15 V output																																																																																			
7	not connected																																																																																			
8	not connected																																																																																			

20.5. Acquisition Data Output

Record a part of or all recording data. In addition, the data can be saved in a different format.

Where to output	Output Format	Output Method
Recording Part	Waveform Recording	Narrowing and Extending the time axis of a wave form is available. Extending 1/1 (standard), 2, 5, 10, 20, 50, and 100 times Narrowing 1/2, 1/5, 1/10, 1/20, 1/50, 1/100, 1/200, 1/500, 1/1000, 1/2000, 1/5000, and 1/10000 * Standard (one time) = 100data/div
	X-Y Recording	
File	Binary	All specified range of data is saved.
	CSV	Saving data internal 1, 2, 5, 10, 20, 50, 100, 200, 500, and 1000 steps

20.6. Standard Function

Function Name	Function Details
Screen Copy	Hard copy of displayed screen with recording part is available.
Saving Screen Image	Saving to a file in bitmap format is available.
Paper Feeding	While pushing Paper Feeding key, preliminary feeding of a recording paper is available.
Initialization	A main unit can be reset to the default setting.
When Using an Optional RS-232C and Recommended UPS	When recovering from power failure or power interruption, the original state can be automatically restored.
Saving and loading data and setting information	Saving memory recording data and maximum four setting conditions of a main unit can be saved to media.
Test Print	Printing state can be confirmed.
Data No. setting	Any measuring data number can be assigned to each measuring data.
Backlight Auto Off	If no settings and operations are made for a fixed time (from 1 to 60 minutes) with the operation panel key or the touch panel key, the backlight is automatically turned off
Alarm/Error Displaying Function	When an error occurs (recording paper empty, release of thermal head connecting, and abnormal rise of thermal head temperature), an alarm can be raised. An error window is also displayed.
Memory Space Changing Function	Restricting the number of channels used for memory recording enable increasing memory space per channel.

20.7. Interface

20.7.1. LAN (Standard)

Spec	Communication speed: 100–BASE-TX Communication Protocol: TCP/IP *A category 5 LAN cable must be used.
------	--

20.7.2. USB (Standard)

Spec	USB port x 2, USB 1.1.
------	------------------------

20.7.3. TRIG IN/TRIG OUT (Standard)

Spec	TRIG IN: 0 to 5 voltage input (LOW level: 0.5V or less, HIGH level: 4.5V or more) TRIG OUT: When a trigger condition is met, TTL level voltage signals (Active Low, Pulse width approx, 10ms) is output.
------	---

20.8.Remote Unit (RA23-144:Optional)

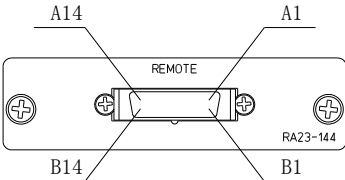
Function	Electric signals controls start or stop of recording/recording, paper feeding, mark input, and input/output for synchronized operation. In addition, recording waveforms and acquiring memory synchronized external pulse signals are available. External input enables preventing the corruption of data files by power failure and the output of a main unit's errors.																																																																																																																																										
Specification	<table border="1" data-bbox="373 465 1386 618"> <thead> <tr> <th data-bbox="373 465 711 506">0-5V Voltage Input</th> <th data-bbox="711 465 1050 506">0-5 Voltage Output</th> <th data-bbox="1050 465 1386 506">Relay Connetion</th> </tr> </thead> <tbody> <tr> <td data-bbox="373 506 711 618">LOW Level less than 0.5 V HIGH Legel more than 4.5 V</td> <td data-bbox="711 506 1050 618">LOW Level less than1.0 V (IOL=less than 5 mA) HIGH Level more than 4.0 V (IoH=less than 5 mA)</td> <td data-bbox="1050 506 1386 618">Current less than 25 mA Voltage more than 50 V</td> </tr> </tbody> </table>					0-5V Voltage Input	0-5 Voltage Output	Relay Connetion	LOW Level less than 0.5 V HIGH Legel more than 4.5 V	LOW Level less than1.0 V (IOL=less than 5 mA) HIGH Level more than 4.0 V (IoH=less than 5 mA)	Current less than 25 mA Voltage more than 50 V																																																																																																																																
0-5V Voltage Input	0-5 Voltage Output	Relay Connetion																																																																																																																																									
LOW Level less than 0.5 V HIGH Legel more than 4.5 V	LOW Level less than1.0 V (IOL=less than 5 mA) HIGH Level more than 4.0 V (IoH=less than 5 mA)	Current less than 25 mA Voltage more than 50 V																																																																																																																																									
Connector	Connector System:8850-028-170-LD 																																																																																																																																										
Pin Configuration	<table border="1" data-bbox="357 887 1422 1901"> <thead> <tr> <th rowspan="2">Pin No.</th> <th colspan="2">Supplied Cable</th> <th rowspan="2"></th> <th rowspan="2">Signal</th> <th rowspan="2">Notes</th> </tr> <tr> <th>Wire</th> <th>Mark</th> </tr> </thead> <tbody> <tr> <td>A1</td> <td rowspan="2">Amber</td> <td>Red -</td> <td>+</td> <td rowspan="2">SYNC IN</td> <td rowspan="2">External Pulse Synchronized Signal Input</td> </tr> <tr> <td>A2</td> <td>Black -</td> <td>-</td> </tr> <tr> <td>A3</td> <td rowspan="2">Gray</td> <td>Red -</td> <td>+</td> <td rowspan="2">REC IN</td> <td rowspan="2">Start ON/OFF Signal Input</td> </tr> <tr> <td>A4</td> <td>Black -</td> <td>-</td> </tr> <tr> <td>A5</td> <td rowspan="2">White</td> <td>Red -</td> <td>+</td> <td rowspan="2">MARK IN</td> <td rowspan="2">External Even Mark Signal Input</td> </tr> <tr> <td>A6</td> <td>Black -</td> <td>-</td> </tr> <tr> <td>A7</td> <td rowspan="2">Yellow</td> <td>Red -</td> <td>+</td> <td rowspan="2">FEED IN</td> <td rowspan="2">Paper Feeding Signal Input</td> </tr> <tr> <td>A8</td> <td>Black -</td> <td>-</td> </tr> <tr> <td>A9</td> <td rowspan="2">Pink</td> <td>Red -</td> <td>+</td> <td rowspan="2">UPS DOWN</td> <td rowspan="2">Power Failure Input</td> </tr> <tr> <td>A10</td> <td>Black -</td> <td>-</td> </tr> <tr> <td>A11</td> <td rowspan="2">Amber</td> <td>Red - -</td> <td>+</td> <td rowspan="2">RESET IN</td> <td rowspan="2">Reset Signal Input</td> </tr> <tr> <td>A12</td> <td>Black - -</td> <td>-</td> </tr> <tr> <td>A13</td> <td rowspan="2">Gray</td> <td>Red - -</td> <td>+</td> <td rowspan="2">EXT SAMPLE IN</td> <td rowspan="2">External Sample Signal Input</td> </tr> <tr> <td>A14</td> <td>Black - -</td> <td>-</td> </tr> <tr> <td>B1</td> <td rowspan="2">White</td> <td>Red - -</td> <td>+</td> <td rowspan="2">SYNC OUT</td> <td rowspan="2">External Pulse Synchronized Signal Output</td> </tr> <tr> <td>B2</td> <td>Black - -</td> <td>-</td> </tr> <tr> <td>B3</td> <td rowspan="2">Yellow</td> <td>Red - -</td> <td>+</td> <td rowspan="2">REC OUT</td> <td rowspan="2">Start ON/OFF Signal</td> </tr> <tr> <td>B4</td> <td>Black - -</td> <td>-</td> </tr> <tr> <td>B5</td> <td rowspan="2">Pink</td> <td>Red - -</td> <td>+</td> <td rowspan="2">MARK OUT</td> <td rowspan="2">External Even Mark Signal Output</td> </tr> <tr> <td>B6</td> <td>Black - -</td> <td>-</td> </tr> <tr> <td>B7</td> <td rowspan="2">Amber</td> <td>Red - - -</td> <td>+</td> <td rowspan="2">FEED OUT</td> <td rowspan="2">Paper Feeding Signal Output</td> </tr> <tr> <td>B8</td> <td>Black - - -</td> <td>-</td> </tr> <tr> <td>B9</td> <td rowspan="2">Gray</td> <td>Red - - -</td> <td>+</td> <td rowspan="2">ERROR OUT</td> <td rowspan="2">Error Output</td> </tr> <tr> <td>B10</td> <td>Black - - -</td> <td>-</td> </tr> <tr> <td>B11</td> <td rowspan="2">White</td> <td>Red - - -</td> <td>+</td> <td rowspan="2">POWER</td> <td rowspan="2">Power Supply Status Output (Relay Connetion)</td> </tr> <tr> <td>B12</td> <td>Black - - -</td> <td>-</td> </tr> <tr> <td>B13</td> <td rowspan="2">Yellow</td> <td>Red - - -</td> <td>+</td> <td rowspan="2">N.C. COM</td> <td rowspan="2"></td> </tr> <tr> <td>B14</td> <td>Black - - -</td> <td>-</td> </tr> </tbody> </table>					Pin No.	Supplied Cable			Signal	Notes	Wire	Mark	A1	Amber	Red -	+	SYNC IN	External Pulse Synchronized Signal Input	A2	Black -	-	A3	Gray	Red -	+	REC IN	Start ON/OFF Signal Input	A4	Black -	-	A5	White	Red -	+	MARK IN	External Even Mark Signal Input	A6	Black -	-	A7	Yellow	Red -	+	FEED IN	Paper Feeding Signal Input	A8	Black -	-	A9	Pink	Red -	+	UPS DOWN	Power Failure Input	A10	Black -	-	A11	Amber	Red - -	+	RESET IN	Reset Signal Input	A12	Black - -	-	A13	Gray	Red - -	+	EXT SAMPLE IN	External Sample Signal Input	A14	Black - -	-	B1	White	Red - -	+	SYNC OUT	External Pulse Synchronized Signal Output	B2	Black - -	-	B3	Yellow	Red - -	+	REC OUT	Start ON/OFF Signal	B4	Black - -	-	B5	Pink	Red - -	+	MARK OUT	External Even Mark Signal Output	B6	Black - -	-	B7	Amber	Red - - -	+	FEED OUT	Paper Feeding Signal Output	B8	Black - - -	-	B9	Gray	Red - - -	+	ERROR OUT	Error Output	B10	Black - - -	-	B11	White	Red - - -	+	POWER	Power Supply Status Output (Relay Connetion)	B12	Black - - -	-	B13	Yellow	Red - - -	+	N.C. COM		B14	Black - - -	-
Pin No.	Supplied Cable			Signal	Notes																																																																																																																																						
	Wire	Mark																																																																																																																																									
A1	Amber	Red -	+	SYNC IN	External Pulse Synchronized Signal Input																																																																																																																																						
A2		Black -	-																																																																																																																																								
A3	Gray	Red -	+	REC IN	Start ON/OFF Signal Input																																																																																																																																						
A4		Black -	-																																																																																																																																								
A5	White	Red -	+	MARK IN	External Even Mark Signal Input																																																																																																																																						
A6		Black -	-																																																																																																																																								
A7	Yellow	Red -	+	FEED IN	Paper Feeding Signal Input																																																																																																																																						
A8		Black -	-																																																																																																																																								
A9	Pink	Red -	+	UPS DOWN	Power Failure Input																																																																																																																																						
A10		Black -	-																																																																																																																																								
A11	Amber	Red - -	+	RESET IN	Reset Signal Input																																																																																																																																						
A12		Black - -	-																																																																																																																																								
A13	Gray	Red - -	+	EXT SAMPLE IN	External Sample Signal Input																																																																																																																																						
A14		Black - -	-																																																																																																																																								
B1	White	Red - -	+	SYNC OUT	External Pulse Synchronized Signal Output																																																																																																																																						
B2		Black - -	-																																																																																																																																								
B3	Yellow	Red - -	+	REC OUT	Start ON/OFF Signal																																																																																																																																						
B4		Black - -	-																																																																																																																																								
B5	Pink	Red - -	+	MARK OUT	External Even Mark Signal Output																																																																																																																																						
B6		Black - -	-																																																																																																																																								
B7	Amber	Red - - -	+	FEED OUT	Paper Feeding Signal Output																																																																																																																																						
B8		Black - - -	-																																																																																																																																								
B9	Gray	Red - - -	+	ERROR OUT	Error Output																																																																																																																																						
B10		Black - - -	-																																																																																																																																								
B11	White	Red - - -	+	POWER	Power Supply Status Output (Relay Connetion)																																																																																																																																						
B12		Black - - -	-																																																																																																																																								
B13	Yellow	Red - - -	+	N.C. COM																																																																																																																																							
B14		Black - - -	-																																																																																																																																								

20.9.RS-232C Unit (RA23-142:Optional)

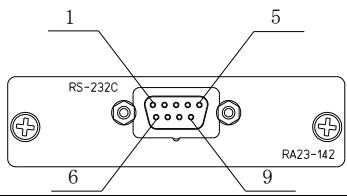
Function	Access host computer, control OMNIACE by commands.																							
Specification	JIS X5101 (formerly C6361)compliance																							
	Data type	Bit Serial																						
	Transmission Speed	38400, 19200, 9600, 4800, and 2400[bps]																						
	Transmission Mode	Start-Stop Transmission, Full-duplex transmission																						
	Start Bit	1[bit]																						
	Data Bit	7,8[bit]																						
	Stop Bit	1,2[bit]																						
Parity Bit	Without parity bit, EVEN, ODD																							
Connector	D Sub-Connector 9 Pin 																							
Mass	Approx. 50g																							
Pin Configuration	<table border="1"> <thead> <tr> <th>Pin No</th> <th>Signal</th> </tr> </thead> <tbody> <tr> <td>1</td> <td>CD(Carrier Detect)</td> </tr> <tr> <td>2</td> <td>RD (Received Data)</td> </tr> <tr> <td>3</td> <td>SD(Transmitted Data)</td> </tr> <tr> <td>4</td> <td>ER(Data Terminal Ready)</td> </tr> <tr> <td>5</td> <td>SG (Signal GND)</td> </tr> </tbody> </table>	Pin No	Signal	1	CD(Carrier Detect)	2	RD (Received Data)	3	SD(Transmitted Data)	4	ER(Data Terminal Ready)	5	SG (Signal GND)	<table border="1"> <thead> <tr> <th>Pin No</th> <th>Signal</th> </tr> </thead> <tbody> <tr> <td>6</td> <td>DR (Data set Ready)</td> </tr> <tr> <td>7</td> <td>RS(Request to Send)</td> </tr> <tr> <td>8</td> <td>CS (Clear to Send)</td> </tr> <tr> <td>9</td> <td>RI(Ring Indicator)</td> </tr> </tbody> </table>	Pin No	Signal	6	DR (Data set Ready)	7	RS(Request to Send)	8	CS (Clear to Send)	9	RI(Ring Indicator)
	Pin No	Signal																						
1	CD(Carrier Detect)																							
2	RD (Received Data)																							
3	SD(Transmitted Data)																							
4	ER(Data Terminal Ready)																							
5	SG (Signal GND)																							
Pin No	Signal																							
6	DR (Data set Ready)																							
7	RS(Request to Send)																							
8	CS (Clear to Send)																							
9	RI(Ring Indicator)																							

20.10. AC Bridge Power Supply Unit (RA23-143:Optional)

Function	Bridge Power for 2CH AC Strain amp unit (AP11-104)
Birdge Power	2Vrms, Sinusoidal Wave 5kHz
Synchronization	With synchronization ternimals, synchronyzation with RA2300 RA2300A included in other Acbridge power supply units is available. With master/slave switch ※Synchronization with RT3424ST is available; Be careful of connector contact..
Mass	Approx. 60g

Notes1) 2CH AC strain amp unit (AP11-104) need including into the main unit to use.

20.11.English Display Unit (RA23-106: Optional, specified at ordering)

Function	Operation Panel, display, recorded contents are written in English.
Instruction Manual	Two different instruction manuals are written in English.

20.12. Dimensions of RA2800A

20.12.1. External Dimensions(Standard Specifications)

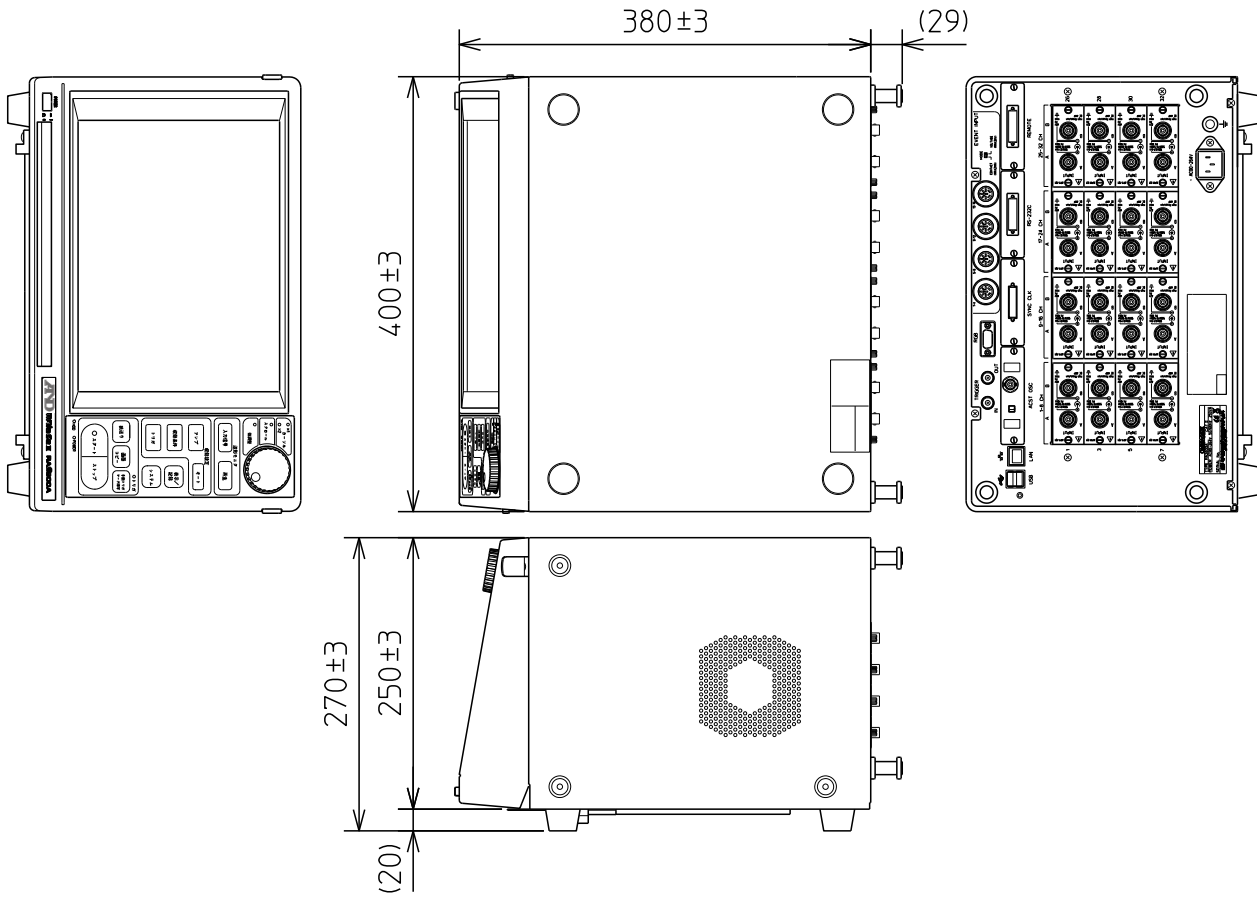

20.12.2. Option Unit Outline Drawing

(1) RS-232C Unit

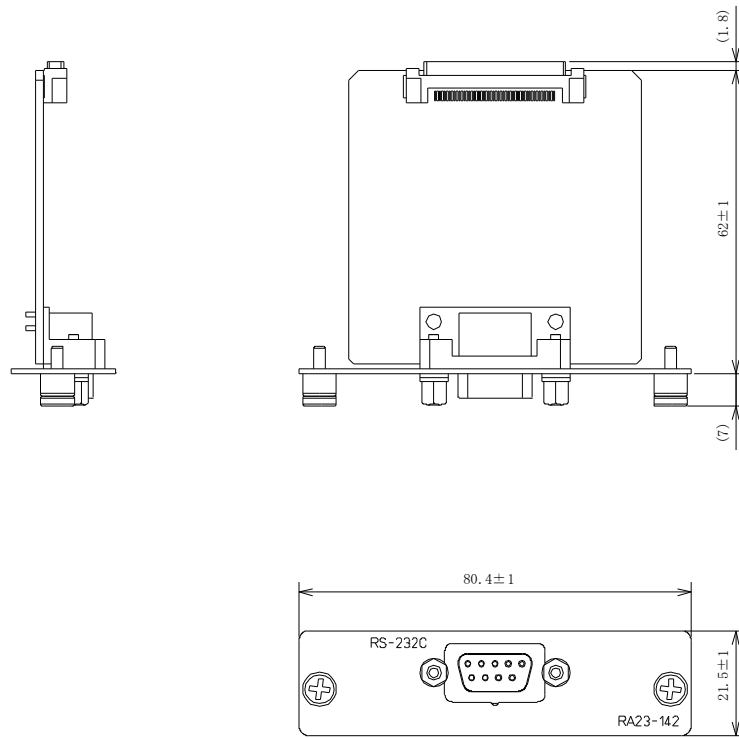

(2) Remote Unit

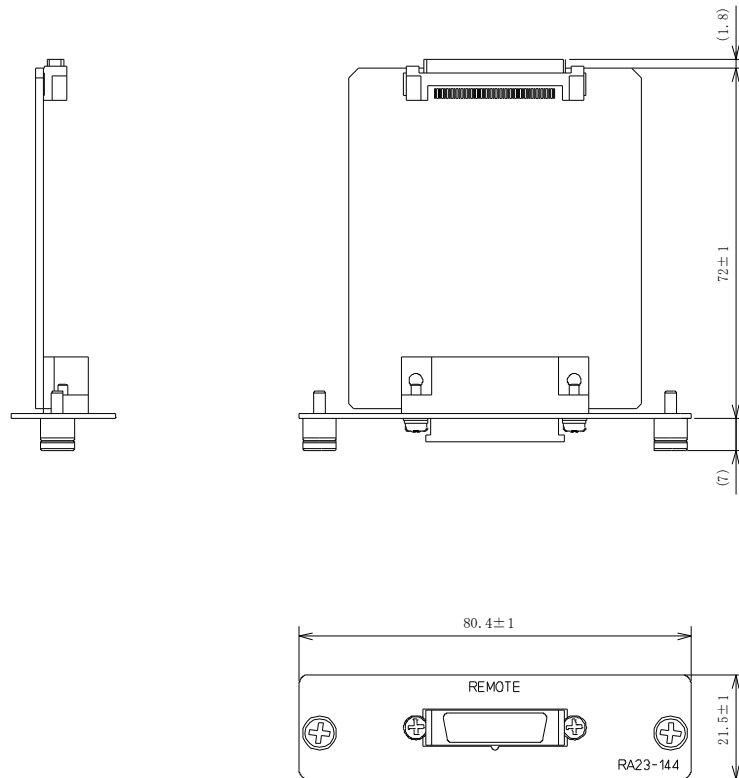

(3) AC Bridge Power Supply Unit

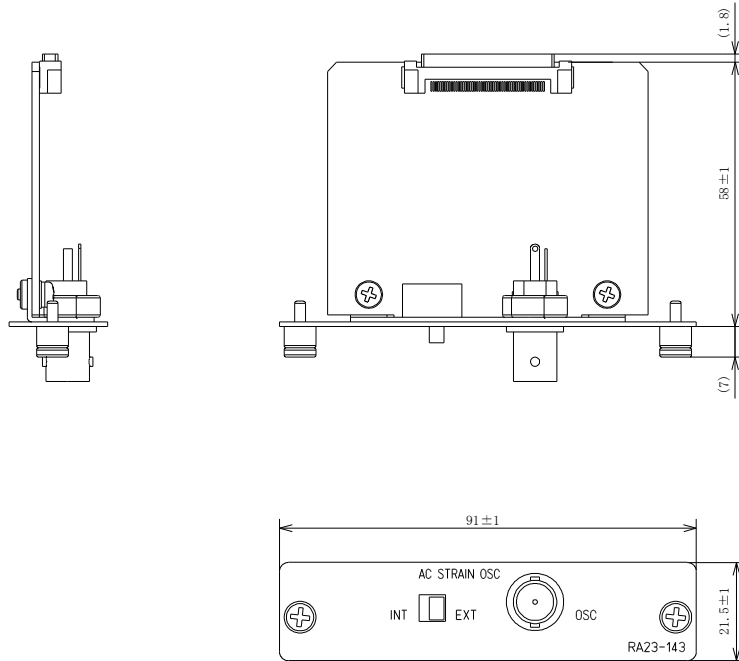

21. Cables · Probes · Spare Parts List

21.1. Cables List

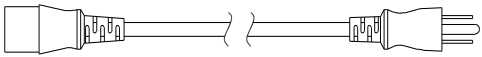
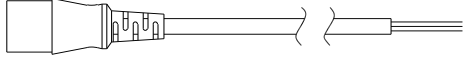
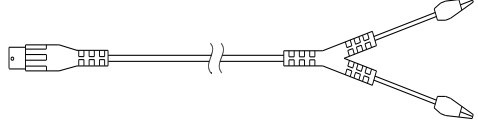
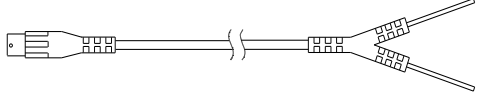
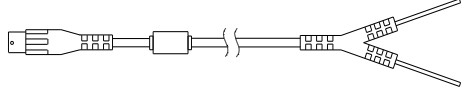
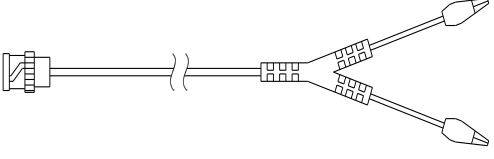
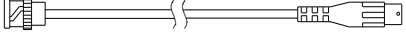
Name(model)	Form		Comment
AC Power Code 100 V (0311-5044)			Length 2.5m
AC Power Code 200 V (0311-5112)			Length 3.5m
Signal input cable (0311-5175)		Safety BNC ←→Alligator Clip Red + Black -	Length 2m
Signal input cable (0311-5177)		Safety BNC ←→Lad Wire Red + Black... -	Length 2m
Signal input cable (0311-5198)		Safety BNC ←→Lead Wire Red + Black - With ferrite core	Length 2m
Trigger input cable (0311-2057)		BNC ←→Alligator Clip Red + Black - Mold color: black	Length 2m
Signal input cable (0311-5200)		BNC ←→Safety BNC	Length 2m

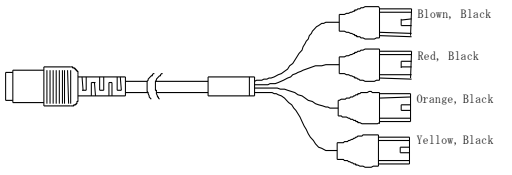
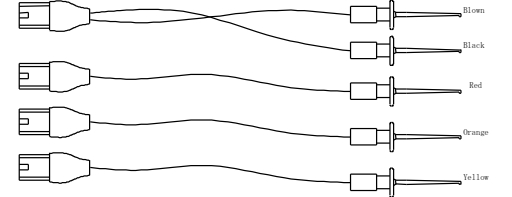
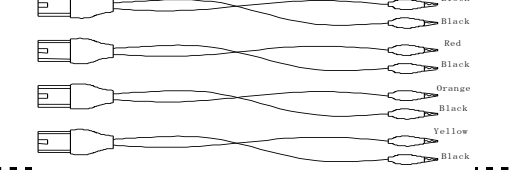
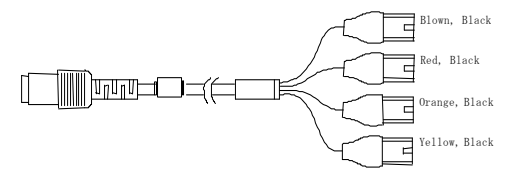
Name (System)	Form	Comment																				
Logic IC code (0311-5007)	 <p>Round DIN8P Plug ←→EI Connector</p> <hr/> <p>Thin wire color</p> <table border="0"> <tr> <td>Blown, Black</td> <td>1ch</td> <td>5ch</td> </tr> <tr> <td>Red, Black</td> <td>2ch</td> <td>6ch</td> </tr> <tr> <td>Orange, Black</td> <td>3ch</td> <td>7ch</td> </tr> <tr> <td>Yellow, Black</td> <td>4ch</td> <td>8ch</td> </tr> </table> <p style="text-align: center;">or</p>	Blown, Black	1ch	5ch	Red, Black	2ch	6ch	Orange, Black	3ch	7ch	Yellow, Black	4ch	8ch	Length 1.5m								
Blown, Black	1ch	5ch																				
Red, Black	2ch	6ch																				
Orange, Black	3ch	7ch																				
Yellow, Black	4ch	8ch																				
IC clip code (0311-5008)	 <p>EI Connector ←→IC Clip</p> <hr/> <p>Thin wire color</p> <table border="0"> <tr> <td>Blown, (+)</td> <td>1ch</td> <td>5ch</td> </tr> <tr> <td>Black (GND)</td> <td></td> <td></td> </tr> <tr> <td>Red, (+)</td> <td>2ch</td> <td>6ch</td> </tr> <tr> <td>Orange, (+)</td> <td>3ch</td> <td>7ch</td> </tr> <tr> <td>Yellow, (+)</td> <td>4ch</td> <td>8ch</td> </tr> </table> <p style="text-align: center;">or</p>	Blown, (+)	1ch	5ch	Black (GND)			Red, (+)	2ch	6ch	Orange, (+)	3ch	7ch	Yellow, (+)	4ch	8ch	Length 15cm					
Blown, (+)	1ch	5ch																				
Black (GND)																						
Red, (+)	2ch	6ch																				
Orange, (+)	3ch	7ch																				
Yellow, (+)	4ch	8ch																				
Alligator clip code (0311-5009)	 <p>EI Connector ←→Alligator Clip</p> <hr/> <p>Wire color</p> <table border="0"> <tr> <td>Blown (+)</td> <td>.....1ch</td> <td rowspan="2">5ch</td> </tr> <tr> <td>Black (GND)</td> <td></td> </tr> <tr> <td>Red (+)</td> <td>.....2ch</td> <td rowspan="2">6ch</td> </tr> <tr> <td>Black (GND)</td> <td></td> </tr> <tr> <td>Orange (+)</td> <td>.....3ch</td> <td rowspan="2">7ch</td> </tr> <tr> <td>Black (GND)</td> <td></td> </tr> <tr> <td>Yellow (+)</td> <td>.....4ch</td> <td rowspan="2">8ch</td> </tr> <tr> <td>Black (GND)</td> <td></td> </tr> </table> <p style="text-align: center;">or</p>	Blown (+)1ch	5ch	Black (GND)		Red (+)2ch	6ch	Black (GND)		Orange (+)3ch	7ch	Black (GND)		Yellow (+)4ch	8ch	Black (GND)		Length 15cm
Blown (+)1ch	5ch																				
Black (GND)																						
Red (+)2ch	6ch																				
Black (GND)																						
Orange (+)3ch	7ch																				
Black (GND)																						
Yellow (+)4ch	8ch																				
Black (GND)																						
Event input cable (RT31-163)	 <p>Logic IC code*(0311-5007) With two ferrite cores Round DIN8P Plug ←→EI Connector</p> <hr/> <p>IC clip code (0311-5008) 2 bags Alligator clip code (0311-5009) 2 bags</p>	Length 1.5m																				

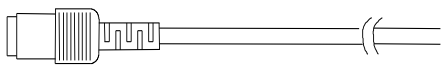
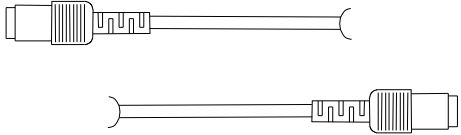
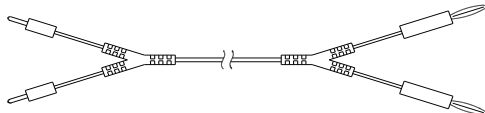
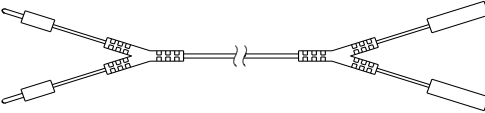
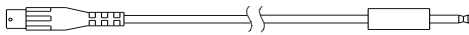
Name(System)	Form	Form	Comment																								
Event input cable (0311-5001)	 <p>Thin cable color</p> <table border="0" data-bbox="475 398 1034 593"> <tr> <td>Blown</td> <td>.....1ch</td> <td></td> <td>5ch</td> </tr> <tr> <td>Red</td> <td>.....2ch</td> <td>or</td> <td>6ch</td> </tr> <tr> <td>Orange</td> <td>.....3ch</td> <td></td> <td>7ch</td> </tr> <tr> <td>Yellow</td> <td>.....4ch</td> <td></td> <td>8ch</td> </tr> <tr> <td>Shield</td> <td>.....GND(0V)</td> <td></td> <td></td> </tr> <tr> <td>White</td> <td>.....+15V Output</td> <td></td> <td></td> </tr> </table> <p>*When the white+15V output wire is not used, make sure to terminate.</p>	Blown1ch		5ch	Red2ch	or	6ch	Orange3ch		7ch	Yellow4ch		8ch	ShieldGND(0V)			White+15V Output			Round DIN8P	Length 1.5m
Blown1ch		5ch																								
Red2ch	or	6ch																								
Orange3ch		7ch																								
Yellow4ch		8ch																								
ShieldGND(0V)																										
White+15V Output																										
Event input extension cable (0311-5005)		Round DIN8P Plug ←→Round DIN8P Socket	Length 1.5m																								
Voltage output cable (0311-5004)		Pin Chip ←→Banana Plug	Length 1.5m																								
Voltage output extension cable (0311-5006)		Pin Chip ←→Pin Chip Jack	Length 1.4m																								
Clamp meter output cable (0311-5184)		Safety BNC ←→Microphone Mini Plug	Length 2m																								

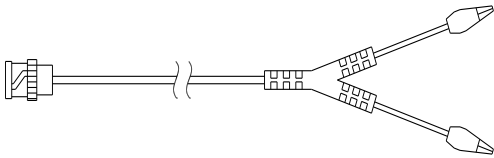
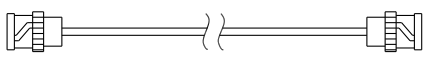
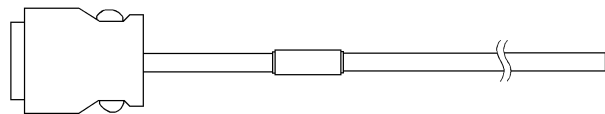
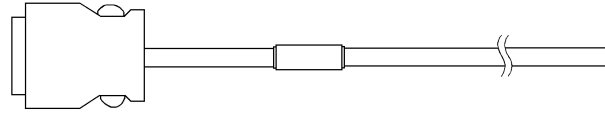
Name(System)	Form		Comment	
Trigger input cable (0311-5084)			BNC ↔Alligator Clip Red...+ Black...- Mold Color : Red	Length 2m
Output cable (47226)			BNC↔BNC	Length 2m
Remote cable (00311-5251-0000)	Connector:28 pin 		Length 1.5m	
Event cable (00311-5252-0000)	Connector:34 pin 		Length 1.5m	

21.2. Probes · Clamp Meter List

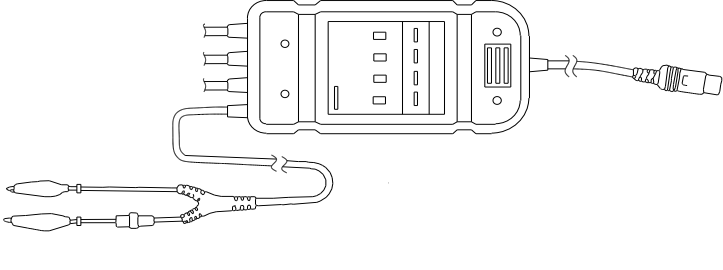
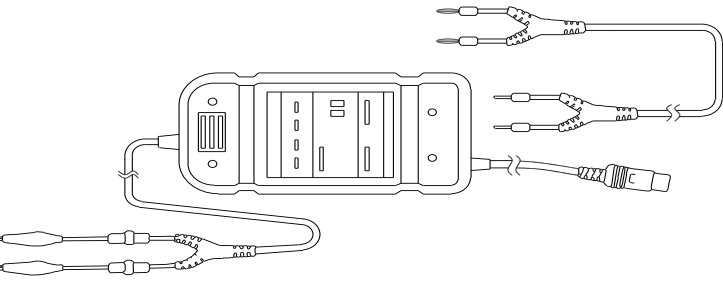
Name(System)	Form	Comment
Floating voltage probe (1539)	 <p data-bbox="427 618 708 680"> Alligator Clip ↔ Round DIN8P Plug </p>	4 Input
Voltage regulation probe (1540: 100/120 VAC) (1543: 220/240 VAC)	 <p data-bbox="427 1066 735 1198"> · Alligator Clip ↔ Round DIN8P Plug · Banana Plug ↔ Pin Chip </p>	1 Input

21.3. Spare Parts List

System	Name	Rating	Comment
YPS106	Recording paper	Roll Paper 219. 5mm × 30 m 5Rolls/Box	0511-3167(5 Rolls)
YPS108	Recording paper	Roll Paper 219. 5mm×30m, 220. With tear-off Strip 150 mm Pitch Remaining Indicator Printing:300 mm Pitch 99 to 00 5Rolls/Box	0511-3166(5 Rolls)
YPS112	Recording paper	Z-Fold Paper 219. 5mm × 200 m, Folding width 300 mm Remaining Indicator Printing: per page 669 to 000 1book/Box	0511-3182
YPS114	Recording paper	Rolled chart paper 219.5mm x 100m 2 rolls/box	0511-3197

To Ensure Prolonged Use

A&D Company,Limited.

Thank you for purchasing an A&D Company,Limited. product.

To ensure prolonged use of the product that you have purchased, we offer the following lineup of maintenance services.

1. **Warranty Period**

The warranty period for this product is one year from the date of purchase (or two years depending on the option). In case of a failure, the product will be repaired free of charge (only if the failure is ascribable to the responsibility of A&D).

2. **Disclaimers**

We take no responsibility for any damages caused by the following reasons;

- (1) Consequential damages and production compensation caused by any accidents of our product;
- (2) Damages of our product generated by other companies' equipments and their construction;
- (3) When operation, proper maintenance, and regular inspection are not done;
- (4) Troubles which are apparently not attributable to our company or those that cannot be decided clearly whether our company is responsible for those troubles;
- (5) Exhaustion of consumptions and repair parts;
- (6) Troubles attributed to third party's conflicts;
- (7) Troubles caused by a force majeure such as natural disasters

Address inquiries to:

- (1) This manual may not be reproduced to any form in whole or in part.
- (2) Then contents in this manual may be updated without prior notice.

RA2800A Series
MAINFRAME Instruction Manual (7001756-R01)

1st Edition: March 2013

2nd Edition: July 2014

3rd Edition: May 2015

A&D Company, Limited



A&D Company, Limited

3-23-14 Higashi-Ikebukuro, Toshima-ku, Tokyo 170-0013, JAPAN

Telephone: [81] (3) 5391-6132 Fax: [81] (3) 5391-6148