

Precision Health Scale

UC-321PL

Instruction Manual

English

Manuel d'instructions

Français

Manual de Instrucciones

Español

Manuale di Istruzioni

Italiano

Bedienungsanleitung

Deutsch

Gebruiksaanwijzing

Nederlands

使用手册

中文

Contents

Before Use

| | |
|---|---|
| Precautions ----- | 1 |
| Scale Components ----- | 2 |
| Display Symbols ----- | 3 |
| Installing (or Replacing) Batteries ----- | 3 |

Operations

| | |
|---|---|
| Basic Measurement ----- | 4 |
| Measuring Your Weight ----- | 4 |
| Measuring an Infant or Small Animal ----- | 5 |
| Measuring Your Weight on a Carpet ----- | 6 |

References

| | |
|---------------------------------|---|
| Specifications ----- | 7 |
| Maintaining the Scale ----- | 7 |
| Before Requesting Service ----- | 8 |

Precautions

- Please read this booklet before using your scale.
- Place your scale on a solid level surface, such as tile, wood, or laminate flooring.
- Do not place your scale on a soft, wet or slippery floor.
If the scale must be used on a carpet, be sure to attach the plastic add-on feet as shown on Page 6.
- Your scale contains delicate, high-precision parts. Avoid extremes in temperature, humidity, direct sunlight, shock, moisture and dust.
- Do not step on your scale with your feet wet. Be sure that your feet are dry to prevent slipping or serious injury.
- Step on the center portion of your scale gently.
- Do not step on the display window.
- Holding the measurement switch for extended periods will shorten battery life.

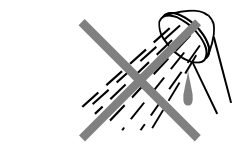
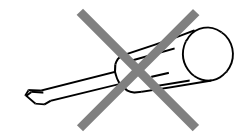
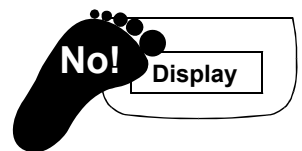

Indications for Use

- This scale is designed for personal use.

Scale Components

Display

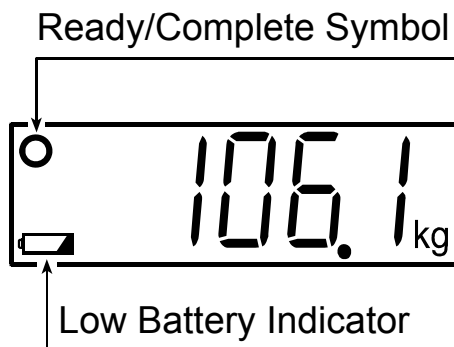

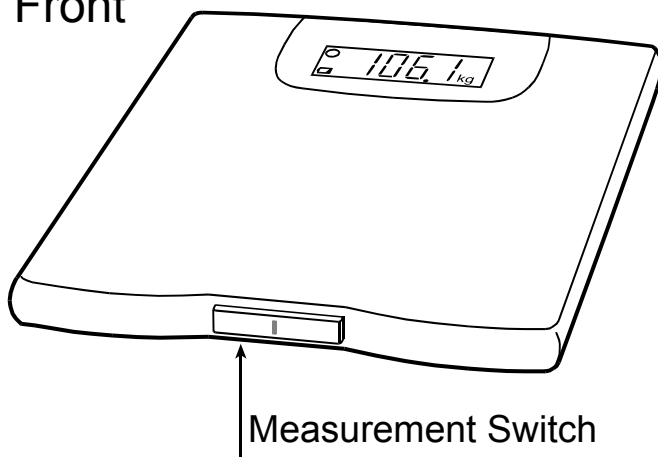

Front



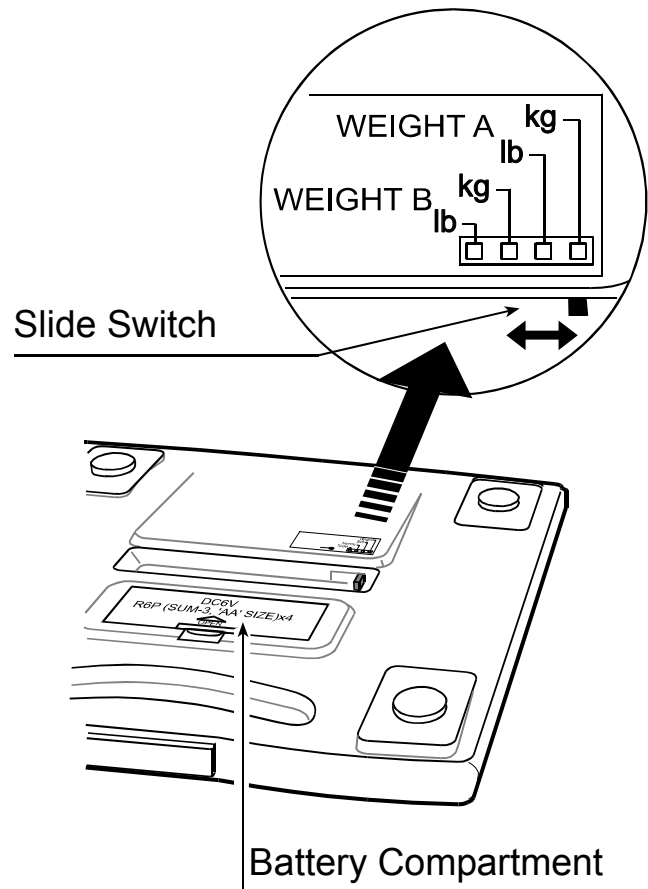

Back



- The following measurements can be selected by the slide switch and are classified into two categories - WEIGHT A and WEIGHT B. Within WEIGHT A and WEIGHT B, you have a choice to select and have your weight displayed in kg or lb. The difference between WEIGHT A and WEIGHT B is the speed of communication from the data port to another device (e.g. modem, printer, telephone). Please follow instructions from your telemonitoring company to select the proper position on the slide switch.
- The scale has an “Automatic power-off” function.
 - If “0.0 kg /0.0 lb” and the Ready/Complete symbol  are displayed about forty-five seconds, the scale will automatically turn off.
 - If the  symbol and the weight are displayed about fifteen seconds, the scale will automatically turn off.

Display Symbols

| | |
|---|--|
|  | Ready/Complete symbol. This symbol is displayed when the measurement display is stable. |
|  | Low battery indicator. If this symbol is displayed, replace all four batteries with new ones. |

Installing (or Replacing) Batteries

Caution

- Insert each battery with its positive (+) and negative (-) terminals properly aligned with the corresponding symbols in the battery compartment.
- Improper installation of the batteries may cause battery leakage.
- Replace all four batteries with new ones, when the  symbol is displayed.
- Do not mix new and used batteries. It may cause damage to the scale or shorten battery life.
- The battery life is dependant upon the environmental temperature, battery type and usage.
- Remove the batteries from the battery compartment, when the scale is not to be used for a long time. They may leak and damage the scale.

Steps for Installing (or Replacing) Batteries

1. Remove the battery compartment cover on the underside of the scale by gently pushing the hook in the direction indicated by the arrow and lifting the cover backward.
2. Install four new batteries with the positive (+) and negative (-) terminals properly aligned with the corresponding symbols in the battery compartment.
3. Replace the cover by sliding it into the compartment and gently pressing into place.

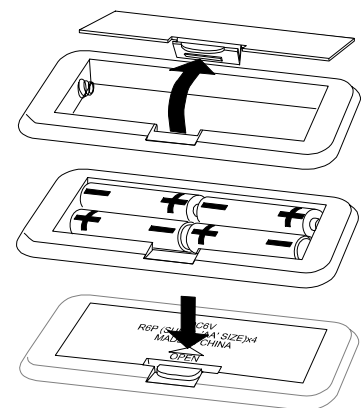

Basic Measurement

Measuring Your Weight

1. **Set the slide switch to the correct mode.**

Example: Set the slide switch to [WEIGHT B].

2. **Press the measurement switch gently.**

All display segments are displayed for several seconds.

3. **Wait until the  symbol is displayed.**

Wait until "0.0 kg /0.0 lb" and the Ready/Complete symbol  are displayed.

Note: If "0.0 kg /0.0 lb" and the Ready/Complete symbol  are displayed about forty-five seconds, the scale will automatically turn off.

4. **Step on the scale gently and stand still during the measurement.**

You will see the display changed to dashes. Please remain still as much as you can.

5. **Your weight is displayed after the  symbol is displayed.**

After about fifteen seconds, the scale will automatically turn off.

6. **Step off the scale.**

Set the slide switch to the correct mode



Press the measurement switch



Ready/Complete symbol

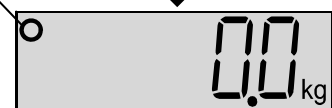

Step on the scale

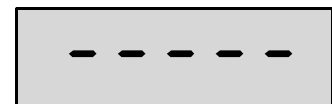

Step off the scale

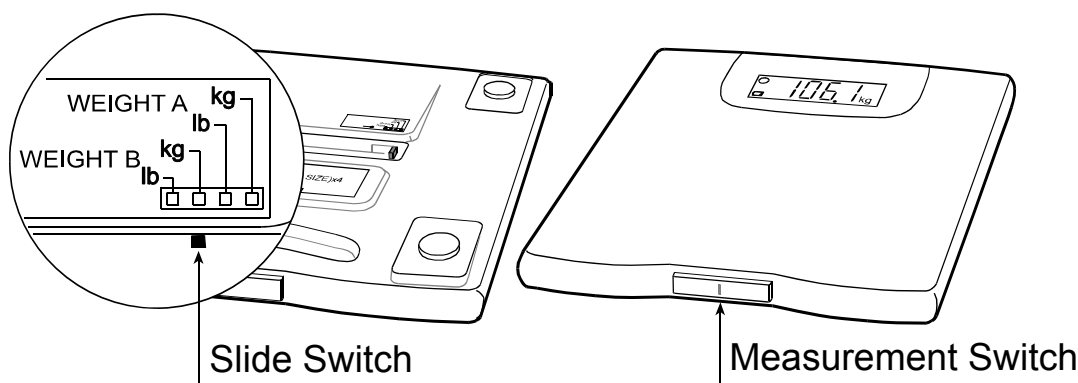

Basic Measurement

Measuring an Infant or Small Animal

1. Set the slide switch to the correct mode.

Example: Set the slide switch to [WEIGHT B].

2. Press the measurement switch gently and step on the scale.

All display segments are displayed for several seconds.

Step on the scale without any baby or animal in your arms before “0.0 kg /0.0 lb” is displayed.

3. Have the infant or the animal placed in your arms

Remain on the scale and have the infant or the animal placed securely in your arms within ten seconds after the scale displays “0.0 kg /0.0 lb” and the Ready/Complete symbol .

Remain still during the measurement until the Ready/Complete symbol  is displayed. You will see the display changed to dashes. Please remain still as much as you can.

Note: If “0.0 kg /0.0 lb” and the Ready/Complete symbol  are displayed about forty-five seconds, the scale will automatically turn off.

4. The weight of the infant or the animal can be read after the  symbol is displayed.

After about fifteen seconds, the scale will automatically turn off.

5. Step off the scale.

Set the slide switch to the correct mode



Press the measurement switch
Step on the scale



Ready/Complete
symbol



Have the infant or the animal
placed in your arms

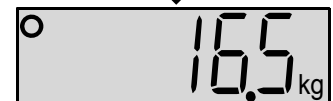
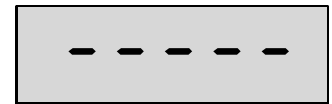

Step off the scale

Measuring Your Weight on a Carpet

Place the scale on a solid level surface, such as tile, wood, or laminate flooring. If the scale must be used on a carpet, be sure to attach the plastic add-on feet.

Steps for Attaching the Add-on Feet

1. Each add-on foot has two pins. Match those pins to the holes on the scale leg and insert firmly.
2. Attach add-on feet on all four legs.

Notes

- Please be careful not to fall when using the add-on feet.
- We recommend using this scale on a solid and level surface.

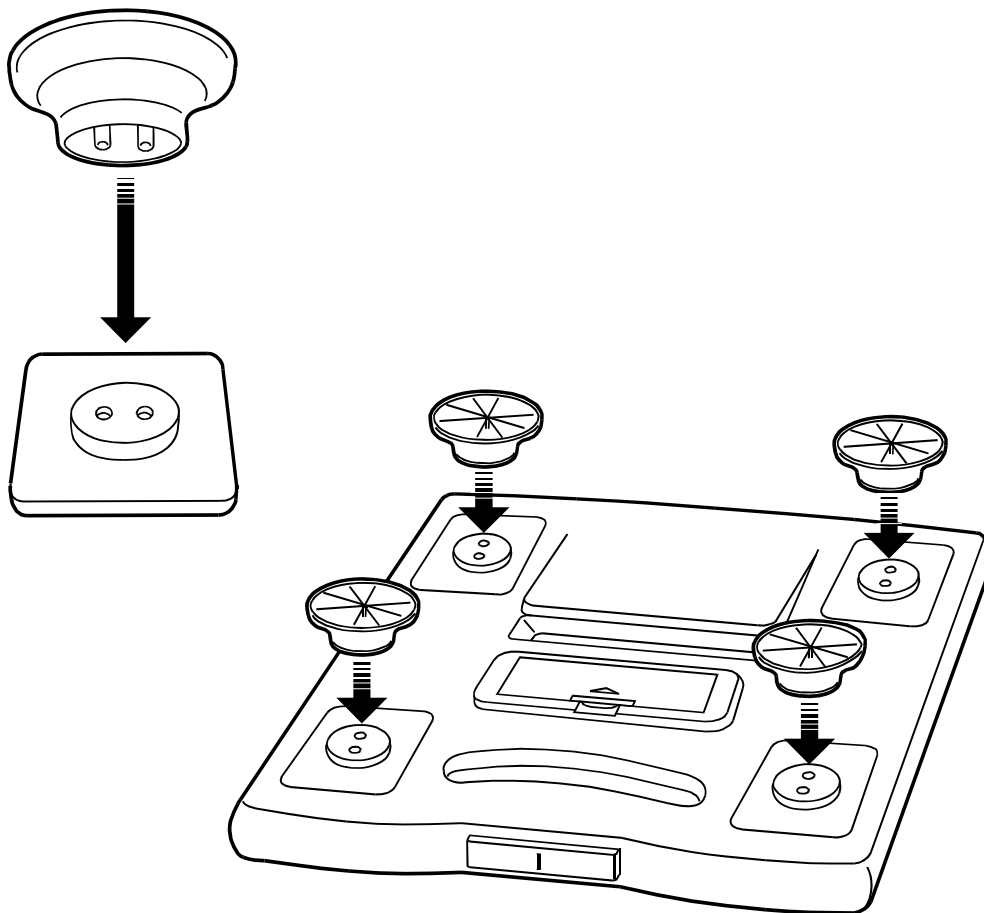

Specifications

| | |
|------------------|--|
| Digital display | Liquid crystal display, 25 mm character height |
| Maximum capacity | 200 kg / 450 lb |
| Minimum display | 0.1 kg / 0.2 lb |
| Power source | Four type AA batteries (R6P or LR6, 1.5 volt x 4) |
| Battery life | Approximately 1000 measurements |
| Accessories | Add-on feet (4), Instruction manual, Batteries (4) |

Specifications are subject to change without prior notice or any obligation on the part of the manufacturer.

Compliance with European Directives

CE The scale complies with the statutory EMC (Electromagnetic Compatibility) directive 2004/108/EC.

Notes: Indoor use only. The displayed value may be adversely affected under extreme electromagnetic influences.

Maintaining the Scale

- Clean the scale with a soft dry cloth or a cloth moistened with water and a mild detergent. Never use alcohol, benzine, thinner or other harsh chemicals to clean the scale.
- Remove the batteries from the battery compartment, when the scale is not going to be used for a long time.

Before Requesting Service

| Problems | Corrective Action |
|---|--|
| Nothing is displayed by pressing the measurement switch. | Check the battery installation. Replace all four batteries with new ones. |
| “88888” remains displayed. “E-0” is displayed. The difference between an estimated weight and a measured weight is excessive. | Remove and reinstall the batteries. Place the scale on a solid level surface. Remove any foreign objects that might be touching the bottom of the scale. When the scale is placed on a carpet, be sure that the add-on feet are attached or try moving the scale to a level surface such as tile or wood. |
|  is displayed. | Replace all four batteries with new ones. |

If you can not locate and fix the problem, contact your supplier, or the A&D service group. The A&D service group will support authorized suppliers with technical information, spare parts and units.



A&D Company, Limited

1-243 Asahi, Kitamoto-shi, Saitama 364-8585 JAPAN
Telephone: [81] (48) 593-1111 Fax: [81] (48) 593-1119

A&D INSTRUMENTS LTD.

Unit 24/26 Blacklands Way, Abingdon Business Park, Abingdon, Oxfordshire OX14 1DY United Kingdom
Telephone: [44] (1235) 550420 Fax: [44] (1235) 550485

A&D ENGINEERING, INC.

1756 Automation Parkway, San Jose, California 95131 U.S.A.
Telephone: [1] (408) 263-5333 Fax: [1] (408)263-0119

A&D Australasia Pty Ltd.

32 Dew Street, Thebarton, South Australia 5031 AUSTRALIA
Telephone: [61] (8) 8301-8100 Fax: [61] (8) 8352-7409

A&D KOREA Limited

한국에이.엔.디(주)
대한민국 서울시 영등포구 여의도동 36-2 맨하탄 B/D 8층
(8th Floor, Manhattan Bldg. 36-2 Yoido-dong, Youngdeungpo-ku, Seoul, KOREA)
전화: [82] (2) 780-4101 팩스: [82] (2) 782-4280