

GP SERIES OPTIONS

GP-04 (Comparator output/RS-232C/
Current loop output)

GP-06 (Analog output/Current loop output)

INSTRUCTION MANUAL

AND
A&D Company, Limited

© 2001 A&D Company Ltd. All rights reserved.

No part of this publication may be reproduced, transmitted, transcribed, or translated into any language in any form by any means without the written permission of A&D Company Ltd.

The contents of this manual and the specifications of the instrument covered by this manual are subject to change for improvement without notice.

CONTENTS

| | |
|------------------------------------------------------------------------|-----------|
| 1. INTRODUCTION | 2 |
| 1-1 Description of the Options | 2 |
| 1-2 Accessories..... | 3 |
| | |
| 2. FUNCTION TABLE | 4 |
| 2-1 Structure and Sequence of the Function Table..... | 4 |
| 2-2 Display and Keys | 4 |
| 2-3 Details of the Function Table | 5 |
| | |
| 3. COMPARATOR OUTPUT (GP-04) | 8 |
| 3-1 Installing the GP-04 Option..... | 8 |
| 3-2 Specifications..... | 9 |
| 3-3 Using the Comparator Output..... | 10 |
| 3-4 Setting the Upper and Lower Limit Values | 11 |
| 3-5 Example of Use | 14 |
| | |
| 4. SERIAL OUTPUT | 15 |
| 4-1 RS-232C (GP-04) Specifications | 15 |
| 4-2 Current Loop Output (GP-04/GP-06) Specifications | 17 |
| 4-3 Connection to the AD-8121 Printer..... | 18 |
| 4-4 Description of the Item "Data output mode"..... | 18 |
| 4-5 Description of the Item "Data format" | 20 |
| 4-6 Description of the Data Format Added to the Weighing Data | 22 |
| 4-7 Data Format Examples..... | 23 |
| 4-8 Connection to a Computer..... | 24 |
| 4-9 Using Windows Communication Tools (WinCT)..... | 25 |
| 4-10 Using the WinCT software, the balance can do the following: | 25 |
| 4-11 Commands..... | 26 |
| 4-12 Acknowledge Code and Error Codes | 27 |
| 4-13 Control Using CTS and RTS..... | 27 |
| 4-14 Settings Related to RS-232C..... | 27 |
| | |
| 5. ANALOG OUTPUT (GP-06) | 28 |
| 5-1 Installing the GP-06 Option..... | 28 |
| 5-2 Analog Output (GP-06) Specifications | 29 |
| 5-3 Analog Output (<i>R_{out}</i>)..... | 30 |
| 5-4 Switching Output Voltage..... | 32 |
| 5-5 Output Voltage Fine Adjustment | 32 |
| 5-6 Fixed Output Voltage | 33 |

1. INTRODUCTION

This manual describes how the GP series options, GP-04 and GP-06 work, and how to get the most out of them in terms of performance.

Read this manual thoroughly before using either option and keep it at hand for future reference.

1-1 Description of the Options

The description of the options is as follows:

- GP-04: Comparator output with a buzzer / RS-232C / Current loop output
- GP-06: Analog output / Current loop output

Functions and panel view

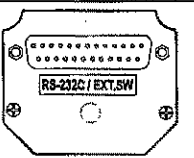
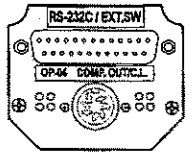
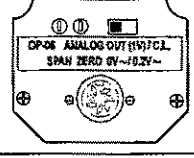
| | Function | | | | Panel view |
|--------------------------------------------------------------------|----------|---------------------|-------------------|---------------|---------------------------------------------------------------------------------------|
| | RS-232C | Current loop output | Comparator output | Analog output | |
| Standard • RS-232C | ○ | - | - | - |  |
| GP-04 • Comparator output • RS-232C • Current loop output | ○ | ○ | ○ | - |  |
| GP-06 • Analog output • Current loop output | - | ○ | - | ○ |  |

○:Available, -:Not available

Notes

Options GP-04 and GP-06 can not be used at the same time. The current loop interface is of the passive type, and an external power supply that provides 20 mA, is required. The external power supply is not necessary when connecting an AD-8121 printer with this current loop interface.

When option GP-04 or GP-06 is used, the display does not comply with IP65 (Dust-tight and Protected Against Water Jets). So, handle the scale with much care when either option is installed.

■ Comparator output

Contact-outputs, output the comparison results between the weighing data and upper/lower limit values, using **HI**, **OK**, and **LO**

Whether or not to sound a buzzer, depending on the results, can be selected.

■ Analog output

Two modes are available: To convert the specified weight value digits to voltage, and to convert the weight value, in the range from zero to the weighing capacity, to voltage.

Output voltage range selection: Using the slide switch located on the option panel, the output voltage range can be switched between 0-1 V and 0.2-1V. The default setting at shipment is 0-1V.

■ RS-232C

The RS-232C interface is used to communicate with a printer or a personal computer. Using the RS-232C interface, the following operations are available through a command from the computer:

- | | |
|----------------------------|---------------------------------|
| Outputs the weighing data. | Enters balance settings. |
| Controls the balance. | Retrieves the balance settings. |

■ Current loop



Current loop is a data output interface, mainly used as a printer interface.

■ GLP output

GLP-compliant data output is available for RS-232C and current loop. Refer to the balance instruction manual for details about GLP output.

1-2 Accessories

Each option is provided with the following accessories.

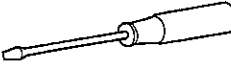
- | | | |
|------------------------------------|---------|---------------------------------------------------------------------------------------|
| • GP-04: DIN connector (plug) | 1 piece |  |
| Instruction manual (this document) | 1 copy | |
| • GP-06: DIN connector (plug) | 1 piece |  |
| Screwdriver | 1 piece |  |
| Instruction manual (this document) | 1 copy | |

2. FUNCTION TABLE

The function table reads or rewrites the parameters that are stored in the balance. When GP-04 or GP-06 is used, set the function table to specify the balance performance. These parameters are maintained in non-volatile memory, even if the AC adapter is removed.

2-1 Structure and Sequence of the Function Table

The function table menu consists of two layers. The first layer is the "Class" and the second layer is the "Item". Each item stores a parameter.

Example

This example sets "Stores weighing data" for "Data memory" and "1 minute" for "Interval time".

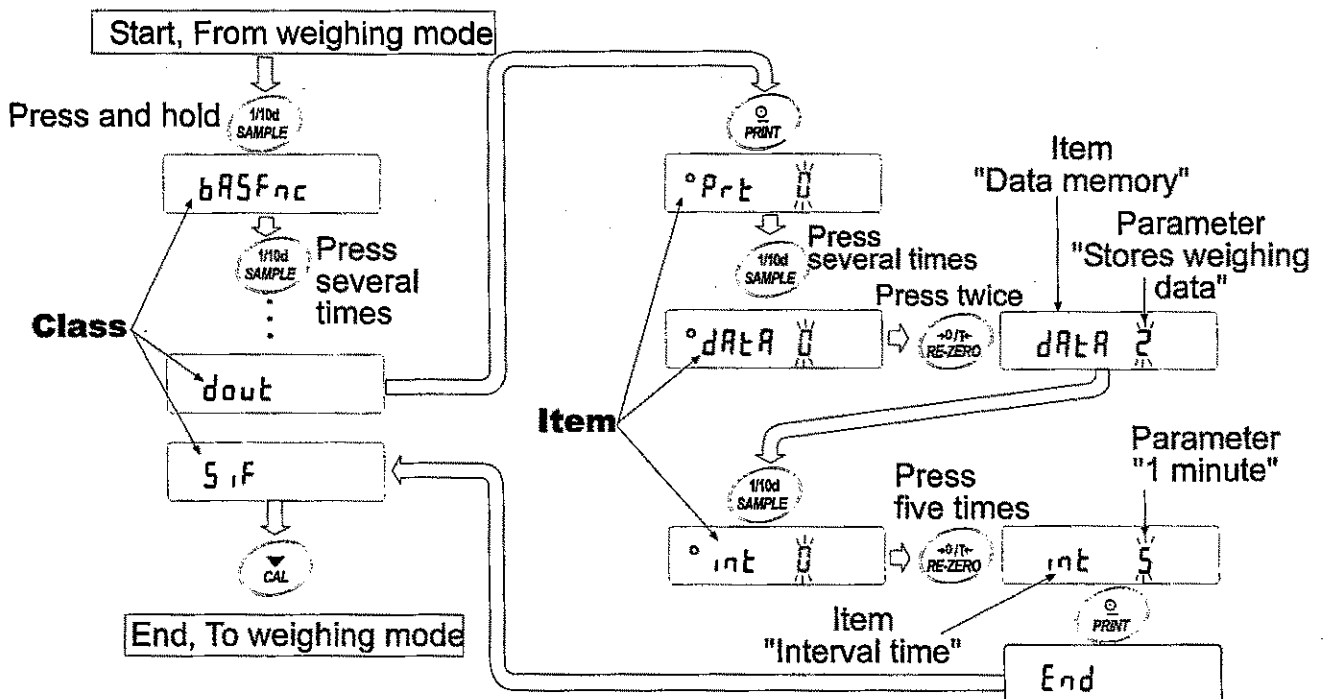

Note

The balance may not function properly, depending on the settings and the operating environment. Be sure to set the parameters correctly.

2-2 Display and Keys

| Display/Key | Description |
|-------------|------------------------------------------------------------------------------------------------------------------------------------------------------------------------------|
| | The symbol "○" indicates that the parameter displayed is in effect. |
| | When pressed and held in the weighing mode, enters the function table mode. Selects the class or item in the function table mode. |
| | Changes the parameter. |
| | When a class is displayed, moves to an item in the class. When an item is displayed, stores the new parameter and displays the next class. |
| | When an item is displayed, cancels the new parameter and displays the next class. When a class is displayed, exits the function table mode and returns to the weighing mode. |

2-3 Details of the Function Table

| Class | Item | Parameter | Description | | | |
|----------------------------------------------------|------------------------------|-----------------------------------|-----------------------------------------------------------------------|------|---------------------------------------------------------------------------------------------|-------------------------------------------------------------------------------------------------------------------------------------|
| bRSFnc Environment Display | Cond Condition | 0 | Fast response, sensitive value | FAST | Can be changed by response adjustment. With "HoLd 1" sets the averaging time. | |
| | | 1 | | MID. | | |
| | | 2 | Slow response, stable value | SLOW | | |
| | St-b Stability band width | 0 | Stable when within ± 1 digit | | | The stabilization indicator illuminates with the display fluctuation within the range. With "HoLd 1", sets the stabilization range. |
| | | 1 | | | | |
| | | 2 | Stable when within ± 3 digits | | | |
| | HoLd Hold function | 0 | OFF | | | Holds the display when stable in animal mode. With "HoLd 1", [ANIMAL] turns on. |
| | | 1 | ON | | | |
| | Zrc Zero tracking | 0 | OFF | | | Keeps zero display by tracking zero drift. |
| | | 1 | ON | | | |
| | SPd Display refresh rate | 0 | 5 times/second | | | Period to refresh the display |
| | | 1 | 10 times/second | | | |
| | Pnt Decimal point | 0 | Point (.) | | | Decimal point format |
| 1 | | Comma (,) | | | | |
| P-on Auto display-ON | 0 | OFF | | | Turns on the weighing mode display when AC adapter is connected. | |
| | 1 | ON | | | | |
| P-off Auto display-OFF | 0 | OFF | | | Turns off the display after 10 minutes of inactivity. | |
| | 1 | ON (10 minutes) | | | | |
| CS Capacity indicator | 0 | OFF | | | Capacity indicator. Zero: 0% Maximum capacity: 100% | |
| | 1 | ON | | | | |
| Add Accumulation function | 0 | OFF | | | Displays and outputs the total value of the weighing data. | |
| | 1 | ON | | | | |
| rnc Display at start | 0 | Does not display | | | Select whether or not to display the smallest displayable weighing value at weighing start. | |
| | 1 | Displays | | | | |
| CL Add Clock | | | See the balance instruction manual, "9-9 Clock and Calendar Function" | | Confirms and sets the time and date. The time and date are added to output data. | |
| CP Fnc Comparator | CP Comparator mode | 0 | No comparison | | | |
| | | 1 | Comparison, excluding "near zero" when stable value or overloaded | | | |
| | | 2 | Comparison, including "near zero" when stable value or overloaded | | | |
| | | 3 | Continuous comparison, excluding "near zero" | | | |
| | | 4 | Continuous comparison, including "near zero" | | | |
| CP in Data input method | 0 | Sets the upper/lower limit values | | | Select CP hi or CP Lo. | |
| | 1 | Sets the reference value | | | Select CP rEF or CP Lnt. | |
| CP-r Comparison results | 0 | Added | | | Select whether or not to add the comparison results to the output data. | |
| | 1 | Not added | | | | |
| CP-b Main display comparison | 0 | OFF | | | Displays the results on the main portion of the display in place of the weight value. | |
| | 1 | ON | | | | |
| Displayed only when the GP-04 option is installed. | bEP- LO buzzer | 0 | OFF | | Select whether or not to sound the LO buzzer. | |
| | bEP- OK buzzer | 0 | OFF | | Select whether or not to sound the OK buzzer. | |
| | bEP- HI buzzer | 0 | OFF | | Select whether or not to sound the HI buzzer. | |

▪ Factory setting Note: "Digit" is a unit of minimum weighing value.

| Class | Item | Parameter | Description | |
|-------------------------------|---------------------------------|---------------------------------------------------------------|------------------------------------------------------------------------------------------------------------------------------------|----------------------------------------------------------------------------------|
| CP_{Hi} Upper limit | | See the balance instruction manual "9-10 Comparator Function" | Displayed when $CP_{in 0}$ is selected. | |
| CP_{Lo} Lower limit | | | | |
| CP_{rEF} Reference value | | See the balance instruction manual "9-10 Comparator Function" | Displayed when $CP_{in 1}$ is selected. | |
| CP_{Lnt} Tolerance | | | | |
| $dout$ Data output | Prt Data output mode | 0 | Key mode | Accepts the PRINT key only when the display is stable. |
| | | 1 | Auto print mode A (Reference = zero) | Outputs data when the display is stable and |
| | | 2 | Auto print mode B (Reference = last stable value) | conditions of $AP-P$, $AP-b$ and the reference value are met. |
| | | 3 | Stream mode / Interval memory mode | With $dRAA 0$, outputs data continuously; with $dRAA 2$, uses interval memory. |
| | $AP-P$ Auto print polarity | 0 | Plus only | Displayed value > Reference |
| | | 1 | Minus only | Displayed value < Reference |
| | | 2 | Both | Regardless of displayed value |
| | $AP-b$ Auto print difference | 0 | 10 digits | Difference between reference value and displayed value |
| | | 1 | 100 digits | |
| | | 2 | 1000 digits | |
| | $dRAA$ Data memory | 0 | Not used | Related items: Prt , int , $d-na$, $S-td$, $info$ |
| | | 1 | Stores unit mass in counting mode | |
| | | 2 | Stores weighing data | |
| | | 3 | Stores calibration data | |
| | | 4 | Stores comparator settings | |
| | int Interval time | 0 | Every measurement | Interval time in the interval memory mode (with $Prt 3$, $dRAA 2$) |
| | | 1 | 2 seconds | |
| | | 2 | 5 seconds | |
| | | 3 | 10 seconds | |
| | | 4 | 30 seconds | |
| | | 5 | 1 minute | |
| | | 6 | 2 minutes | |
| | | 7 | 5 minutes | |
| | $d-na$ Data number output | 0 | No output | See "11 DATA MEMORY". |
| 1 | | Output | | |
| $S-td$ Time/Date output | 0 | No output | Selects whether or not the time or date is added to the weighing data. For details, refer to "9-9 Clock and Calendar Function". | |
| | 1 | Time only | | |
| | 2 | Date only | | |
| $S-id$ ID number output | 0 | No output | Selects whether or not the ID number is output. | |
| | 1 | Output | | |

■ Factory setting

| Class | Item | Parameter | | Description |
|------------------------------------------------|--------------------------------------|-------------------------------------------------------------------|---------------------------------------------|---------------------------------------------------------------------------------------------------------------------------------------------------|
| <i>dout</i> Data output | <i>PUSE</i> Data output pause | 0 | No pause | Selects the data output interval. |
| | | 1 | Pause (1.6 seconds) | |
| | <i>AE-F</i> Auto feed | 0 | Not used | Selects whether or not auto feed is performed. |
| | | 1 | Used | |
| | <i>inFo</i> GLP output | 0 | No output | Selects GLP output method. For how to set time and date to be added, refer to the balance instruction manual, "9-9: Clock and Calendar Function". |
| | | 1 | AD-8121 format | |
| | | 2 | General data format | |
| | <i>Ar-d</i> Zero after output | 0 | Not used | Adjusts zero automatically after data is output |
| 1 | | Used | | |
| <i>SIF</i> Serial interface | <i>bPS</i> Baud rate | 0 | 600 bps | |
| | | 1 | 1200 bps | |
| | | 2 | 2400 bps | |
| | | 3 | 4800 bps | |
| | | 4 | 9600 bps | |
| | | 5 | 19200 bps | |
| | <i>bPr</i> Data bit, parity bit | 0 | 7 bits, even | |
| | | 1 | 7 bits, odd | |
| | | 2 | 8 bits, none | |
| | <i>CrLF</i> Terminator | 0 | CR LF | CR: ASCII code 0Dh LF: ASCII code 0Ah |
| | | 1 | CR | |
| | <i>TYPE</i> Data format | 0 | A&D standard format | See the balance instruction manual, "9-6 Description of Item "Data Format". |
| | | 1 | DP format | |
| 2 | | KF format | | |
| 3 | | MT format | | |
| 4 | | NU format | | |
| 5 | | CSV format | | |
| <i>t-UP</i> Timeout | 0 | No limit | Selects the wait time to receive a command. | |
| | 1 | 1 second | | |
| <i>ErCd</i> AK, Error code | 0 | No output | AK: ASCII code 06h | |
| | 1 | Output | | |
| <i>cts</i> CTS, RTS control | 0 | Not used | Controls CTS and RTS. | |
| | 1 | Used | | |
| <i>dS Fnc</i> Density function | <i>Ldin</i> Liquid density input | 0 | Water temperature | Available only when density mode is selected. |
| | | 1 | Liquid density | |
| <i>nLE</i> Programmable-unit (Multi-unit) | | Sets an arbitrary coefficient. | | Available only when programmable unit mode is selected. |
| <i>Unit</i> Unit | | See the balance instruction manual, "4. WEIGHING UNITS". | | |
| <i>CS in</i> Internal mass value correction | | See the balance instruction manual, "7. CALIBRATION". | | Displayed only when the internal mass value correction switch is set to 1. |
| <i>Rowt</i> Analog output | <i>An</i> Analog output mode | 0 | 2-digit output | Displayed only when the GP-06 option is installed. |
| | | 1 | 3-digit output | |
| | | 2 | Net full scale output | |
| | | 3 | Gross full scale output | |
| | <i>SEL</i> Output digit selection | 0 | First digit | Displayed only when the GP-06 option is installed. |
| | | 1 | Second digit | |
| | | 2 | Third digit | |
| | | 3 | Fourth digit | |
| | | 4 | Fifth digit | |
| | | 5 | Sixth digit | |
| <i>id</i> ID number setting | | See the balance instruction manual "10. ID NUMBER AND GLP REPORT" | | |

▪ Factory setting

Caution

The balance may not transmit the data completely at the specified refresh rate, depending on the baud rate or data added to the weighing data such as time, date and ID number.

3. COMPARATOR OUTPUT (GP-04)

Comparator output, is the function to output the comparison results between the weighing data and upper/lower limit values. Whether or not to sound the buzzer when the contact output is shorted can be set.

3-1 Installing the GP-04 Option

Install the GP-04 option in the following procedures:

1. Remove the option cover, and then remove the RS-232C board.

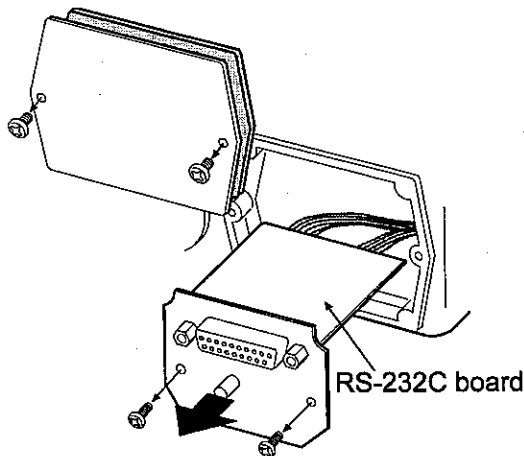

2. Turn the board over so that the connectors can be accessed.
Remove the connectors from the RS-232C board.
They are difficult to remove, so use care.

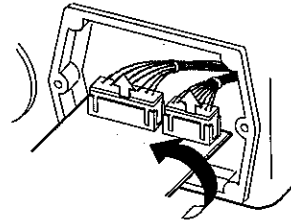

3. Connect the cables, removed from the RS-232C board, to the GP-04 board.

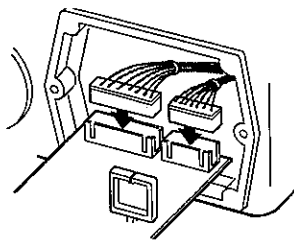

4. Secure the cables in the wire clip.

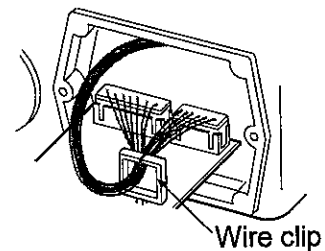

5. Turn the GP-04 board over so that the connectors face downward.
Insert the board into the display casing.
When inserting, lower the edge of the GP-04 board so that the GP-04 board will not touch the board located in the upper side of the casing.
Fasten the GP-04 panel with screws.

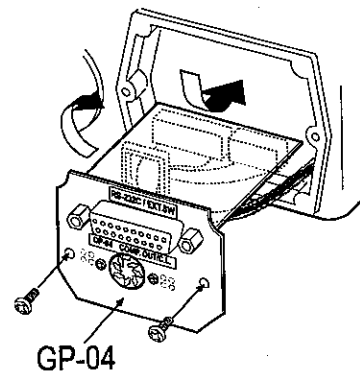

3-2 Specifications

The specifications of the comparator output are as follows:

Maximum contact voltage: 100 VDC

Maximum contact current: 100 mA DC

Maximum contact resistance: 20 Ω

Comparator output judgement conditions (when upper limit value \geq lower limit value):

Weighing data $>$ upper limit value: Activates the HI comparator output.

Upper limit value \geq weighing data \geq lower limit value: Activates the OK comparator output.

Weighing data $<$ lower limit value: Activates the LO comparator output.

Reference value setting: Input the upper and lower limit values digitally or using a sample.

Contact output: Select whether or not to and how to compare, using "CP", comparator mode of the balance function table.

Buzzer: Select whether or not to sound the buzzer, using "bEP", buzzer mode of the balance function table.

Panel view

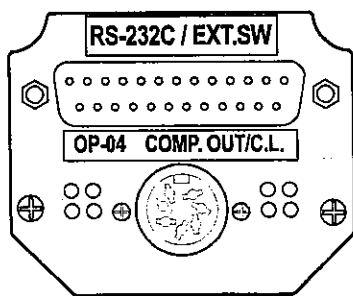

Circuit

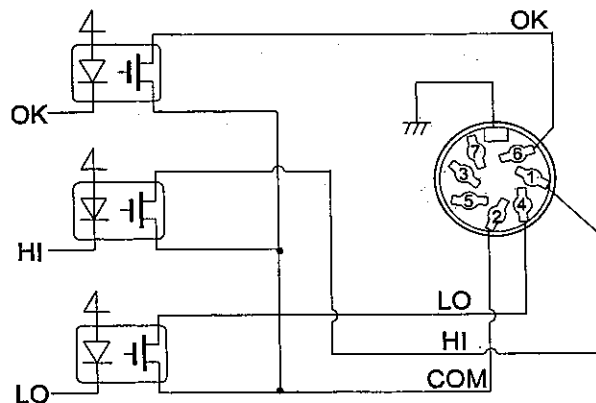

Pin assignments

| Pin No. | Description |
|---------|-----------------------------|
| 1 | HI (Comparator) |
| 2 | COM (Comparator) |
| 3 | Sending loop (Current loop) |
| 4 | LO (Comparator) |
| 5 | Sending loop (Current loop) |
| 6 | OK (Comparator) |
| 7 | No connection |
| Housing | Shield |

For details on current loop, pins 3 and 5, see "4-2 Current Loop Output (GP-04/GP-06) Specifications" on page 17.

3-3 Using the Comparator Output

To use the comparator output, perform the following four steps.

1. Connect the peripheral to the option's 7-pin DIN connector.
2. Set the "Comparator (EP_{Fnc})" of the balance function table. For details, see "2. FUNCTION TABLE".
3. Set the upper and lower limit values. For details, see "3-4 Setting the Upper and Lower Limit values".
4. Perform a weighing. The comparison results will be output.

When the weighing data is equal to or less than the upper limit value, and equal to or greater than the lower limit value, the OK comparator will be output.

| Comparator output | LO | OK | HI |
|-----------------------------------------------------|-------|-------|-------|
| Weighing data > upper limit | Open | Open | Short |
| Upper limit \geq weighing data \geq lower limit | Open | Short | Open |
| Weighing data < lower limit | Short | Open | Open |

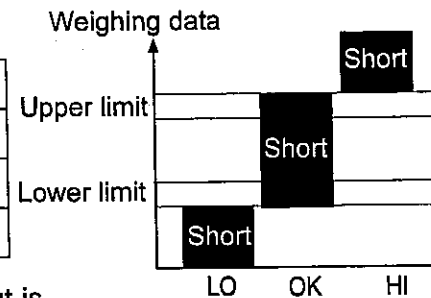

Whether or not to sound the buzzer when the contact output is shorted can be set in the "Buzzer mode (bEP)" of the "Comparator (EP_{Fnc})".

Note

When setting the upper and lower limit values, make sure that the upper limit value is greater than the lower limit value.

Comparator output

| Class | Item | Parameter | Description | |
|----------------------------------------------------|---------------------------------|--------------------------------------------------------------------|-------------------------------------------------------------------|---------------------------------------------------------------------------------------|
| [P Fnc Comparator | [P Comparator mode | 0 | No comparison | |
| | | 1 | Comparison, excluding "near zero" when stable value or overloaded | |
| | | 2 | Comparison, including "near zero" when stable value or overloaded | |
| | | 3 | Continuous comparison, excluding "near zero" | |
| | | 4 | Continuous comparison, including "near zero" | |
| | [P in Data input method | 0 | Sets the upper/lower limit values | Select [P h ₁ or [P L ₀ . |
| | | 1 | Sets the reference value | Select [P rEF or [P Lnt. |
| | [P-r Comparison results | 0 | OFF | Select whether or not to add the comparison results to the output data. |
| | | 1 | ON | |
| | [P-b Main display comparison | 0 | OFF | Displays the results on the main portion of the display in place of the weight value. |
| 1 | | ON | | |
| Displayed only when the GP-04 option is installed. | [P- LO buzzer | 0 | OFF | Select whether or not to sound the LO buzzer. |
| | [P- OK buzzer | 0 | OFF | Select whether or not to sound the OK buzzer. |
| | [P- HI buzzer | 0 | OFF | Select whether or not to sound the HI buzzer. |
| [P H ₁ Upper limit | | See "3-4 Setting the Upper and Lower Limit Values" of this manual. | Displayed when [P in 0 is selected. | |
| [P L ₀ Lower limit | | | | |
| [P rEF Reference value | | See "3-4 Setting the Upper and Lower Limit Values" of this manual. | Displayed when [P in 1 is selected. | |
| [P Lnt Tolerance | | | | |

■ Factory setting

3-4 Setting the Upper and Lower Limit Values

The results of the comparison are indicated by **HI** **OK** **LO** on the display.

Operating conditions: ● No comparison

- Comparison when the weighing data is stable or overloaded, excluding "near zero"
- Comparison when the weighing data is stable or overloaded, including "near zero"
- Continuous comparison, excluding "near zero"
- Continuous comparison, including "near zero"

To compare, use:

- Upper limit value and lower limit value
- Reference value and tolerance value

Input method:

- Digital input
- Weighing input

Setting example 1

(Comparison when the weighing data is stable or overloaded, excluding "near zero", upper limit and lower limit)

Selecting a comparator mode

- 1 Press and hold the **SAMPLE** key until **bRSFnC** of the function table is displayed, then release the key.
- 2 Press the **SAMPLE** key several times to display **[P Fnc]**.
- 3 Press the **PRINT** key.
- 4 Press the **RE-ZERO** key several times to display **[P 1]**.
- 5 Press the **SAMPLE** key to display **[P in]**.
- 6 Press the **RE-ZERO** key several times to display **[P in 0]**.
- 7 Press the **PRINT** key to store the selected mode.

Entering the upper and lower limit values

- 8 With **[P H,]** displayed, press the **PRINT** key. The current setting of the upper limit value is displayed with all of the digits blinking.
 - When the current setting is not to be changed, press the **PRINT** or **CAL** key to proceed to step 9.
 - When the current setting is to be changed, press the **RE-ZERO** key. The balance is now in the digital input mode. To use the weighing input mode, press and hold the **MODE** key.

Digital input mode

Change the setting using the following keys.

| | |
|--------------------|---------------------------------------------|
| SAMPLE key | To select the digit to change the value. |
| RE-ZERO key | To change the value of the digit selected. |
| MODE key | To switch the polarity. |
| PRINT key | To store the new setting and go to step 9. |
| CAL key | To cancel the new setting and go to step 9. |

Weighing input mode

Press the **RE-ZERO** key. The balance displays **00 g**. Place a sample, with a mass that corresponds to the upper limit value, on the pan. Press the **PRINT** key to store the upper limit value. Remove the sample. The balance displays **[P L_u]**.

- 9 With **[P L_u]** displayed, press the **PRINT** key. The current setting of the lower limit value is displayed with all of the digits blinking.
 - When the current setting is not to be changed, press the **PRINT** or **CAL** key to proceed to step 10.
 - When the current setting is to be changed, press the **RE-ZERO** key. The balance is now in the digital input mode. To use the weighing input mode, press and hold the **MODE** key.
Enter the lower limit value in the same way as described in step 8. Then, go to step 10.
- 10 Press the **CAL** key to exit the comparator function and return to the weighing mode.

Setting example 2

(Continuous comparison, including "near zero", reference value and tolerance value)

Selecting a comparator mode

- 1 Press and hold the **SAMPLE** key until **bRSFnC** of the function table is displayed, then release the key.
- 2 Press the **SAMPLE** key several times to display **CP FnC**.
- 3 Press the **PRINT** key.
- 4 Press the **RE-ZERO** key several times to display **CP 4**.
- 5 Press the **SAMPLE** key to display **CP in**.
- 6 Press the **RE-ZERO** key several times to display **CP in 1**.
- 7 Press the **PRINT** key to store the selected mode.

Entering the reference and tolerance values

- 8 With **CP rEF** displayed, press the **PRINT** key. The current setting of the reference value is displayed with all the digits blinking.
 - When the current setting is not to be changed, press the **PRINT** or **CAL** key to proceed to step 9.
 - When the current setting is to be changed, press the **RE-ZERO** key. The balance is now in the digital input mode. To use the weighing input mode, press and hold the **MODE** key.

Digital input mode

Change the setting using the following keys.

| | |
|--------------------|---------------------------------------------|
| SAMPLE key | To select the digit to change the value. |
| RE-ZERO key | To change the value of the digit selected. |
| MODE key | To switch the polarity. |
| PRINT key | To store the new setting and go to step 9. |
| CAL key | To cancel the new setting and go to step 9. |

Weighing input mode

Press the **RE-ZERO** key. The balance displays **00 g**. Place a sample, with a mass that corresponds to the reference value, on the pan. Press the **PRINT** key to store the reference value. Remove the sample and go to step 9.

- 9 With **CP Lnt** displayed, press the **PRINT** key. The current setting of the tolerance value is displayed with all the digits blinking.
 - When the current setting is not to be changed, press the **PRINT** or **CAL** key to proceed to step 10.
 - When the current setting is to be changed, press the **RE-ZERO** key. The balance is now in the digital input mode. Change the setting using the following keys.

| | |
|--------------------|----------------------------------------------|
| SAMPLE key | To select the digit to change the value. |
| RE-ZERO key | To change the value of the digit selected. |
| PRINT key | To store the new setting and go to step 10. |
| CAL key | To cancel the new setting and go to step 10. |

Notes: Enter the tolerance value in percentage, with the reference value as 100%.

Only the digital input mode is available for setting the tolerance value.

The **MODE key is not used to set the tolerance value.**

- 10 Press the **CAL** key to exit the comparator function and return to the weighing mode.

Notes

When Pound/Ounce is selected as a weighing unit, enter the values in ounces for comparison.

In the density mode, comparison is performed to the density obtained.

3-5 Example of Use

The following example uses the AD-8951 comparator light, which is sold separately, to display the comparison result in red, green, or orange.

- 1 Using the AX-KO507-W200 cable, which is sold separately, connect the comparator light to the balance as shown below.

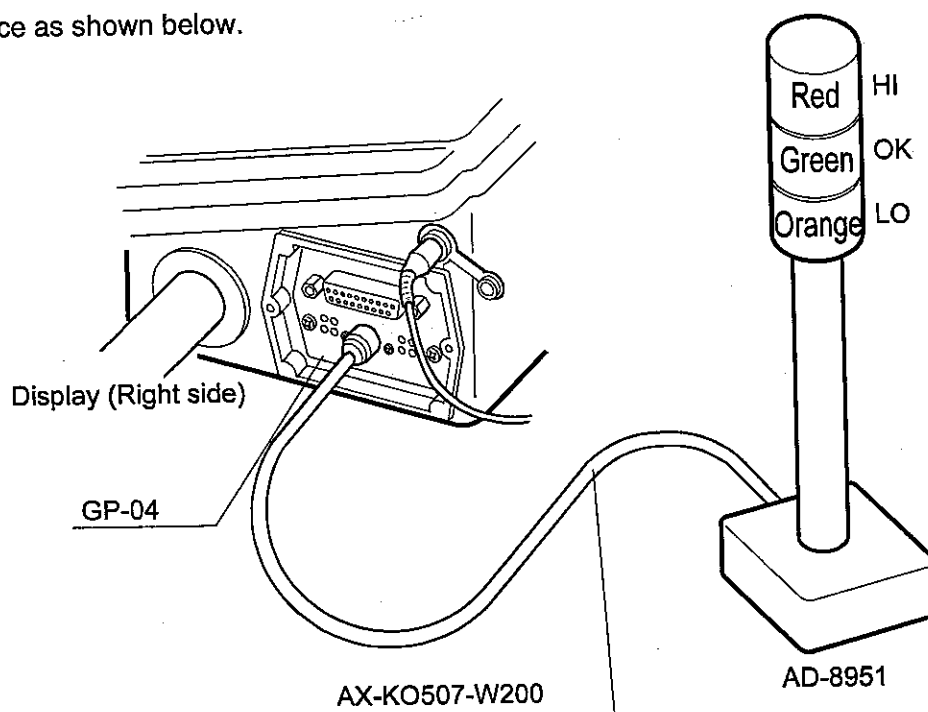

2. Set the "Comparator (CP Fnc)" of the balance function table as follows:
 - [P 3] Compares the result excluding the data near zero continuously.
 - [P in 0] Inputs the upper or lower limit values.
 - bEP- 1 Sounds the buzzer for LO.
 - bEP- 0 Does not sound the buzzer for OK.
 - bEP- 1 Sounds the buzzer for HI.

3. Set the upper and lower limit values as follows:

[P Hi] 10.100 kg (Upper limit)

[P Lo] 9.900 kg (Lower limit)

4. The comparator and buzzer functions as follows, depending on the comparison result.

| Weighing data | Comparator light | Buzzer |
|---------------|------------------|----------------|
| 9.000 kg | Orange | Sounds |
| 10.000 kg | Green | Does not sound |
| 11.000 kg | Red | Sounds |

4. SERIAL OUTPUT

4-1 RS-232C (GP-04) Specifications

D-Sub 25 pin numbers

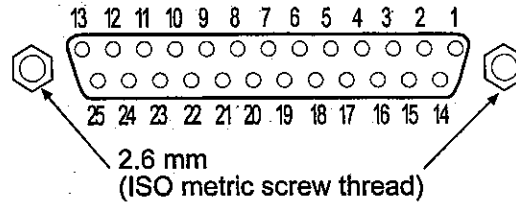

D-Sub 25 pin assignments

| Pin No. | Signal name | Interface type | Direction | Description |
|---------|-------------|--------------------------------|-----------|-------------------------|
| 1 | FG | | | Frame ground |
| 2 | RXD | RS-232C | Input | Receive data |
| 3 | TXD | RS-232C | Output | Transmit data |
| 4 | RTS | RS-232C | Input | Ready to send |
| 5 | CTS | RS-232C | Output | Clear to send |
| 6 | DSR | RS-232C | Output | Data set ready |
| 7 | SG | RS-232C/external contact input | - | Signal ground |
| 18 | PRINT | External contact input | Input | Same as the PRINT key |
| 19 | RE-ZERO | External contact input | Input | Same as the RE-ZERO key |
| Others | - | - | - | No connection |

RS-232C

The balance is a DCE device. Connect the balance to a personal computer (DTE) using a straight through cable.

- Transmission system : EIA RS-232C
- Transmission form : Asynchronous, bi-directional, half duplex
- Transmission rate : 10 times/second or 5 times/second (same as data refresh rate)
- Data format :
 - Baud rate : 600, 1200, 2400, 4800, 9600, 19200bps
 - Data bits : 7 or 8 bits
 - Parity : Even, Odd (Data 7 bits)
None (Data 8 bits)
 - Stop bit : 1 bit
(When sending, 2 bits; receiving, 1 bit.
A personal computer will function with either setting.)
 - Code : ASCII

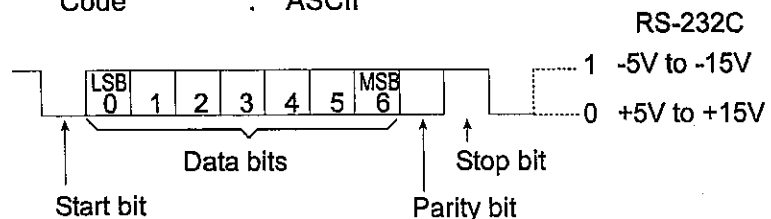

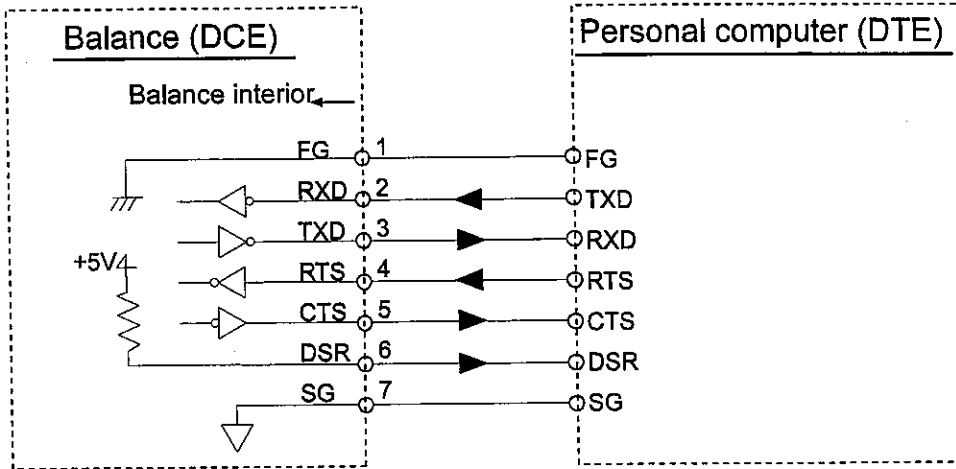

External contact input

By connecting pin 18 to pin 7, or pin 19 to pin 7, for more than 100 ms, the same operation as performed by pressing the **RE-ZERO** key or the **PRINT** key, will be performed.

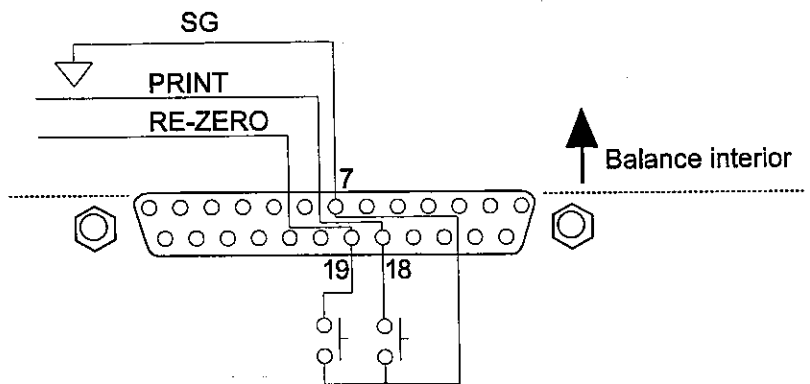

Use of example

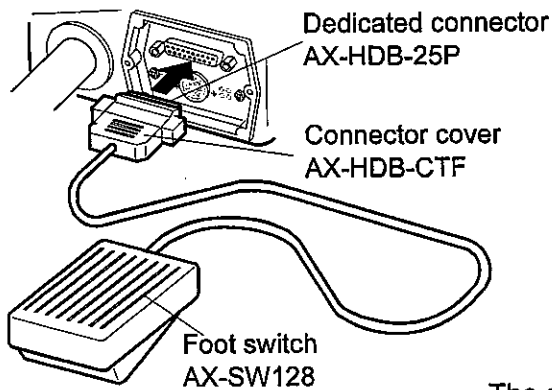

The external input connector (AX-HDB-25P/CTF) and the foot switch (AX-SW128) are sold separately.

4-2 Current Loop Output (GP-04/GP-06) Specifications

The specifications of the current loop interface are as follows:

| | |
|---------------------|-------------------------------------------------------|
| Transmission system | 20 mA current loop (Passive) |
| Transmission | Asynchronous, uni-directional (Only from the balance) |
| Data format | Baud rate: 600, 1200, 2400, 4800, 9600, 19200 bps |
| | Data: 7 or 8 bits |
| | Parity: Even, Odd (Data 7 bits) |
| | None (Data 8 bits) |
| | Stop bit: 1 bit |
| | Code: ASCII |

| Data | Current loop (20 mA) |
|------|----------------------|
| 1 | 20 mA |
| 0 | 0 mA |

Notes

To use current loop, an external power supply that provides 20 mA, is required.

The maximum rated voltage of the current loop is 25 V.

When a baud rate of 4800 bps or higher is used, communication may not be performed properly.

Circuit

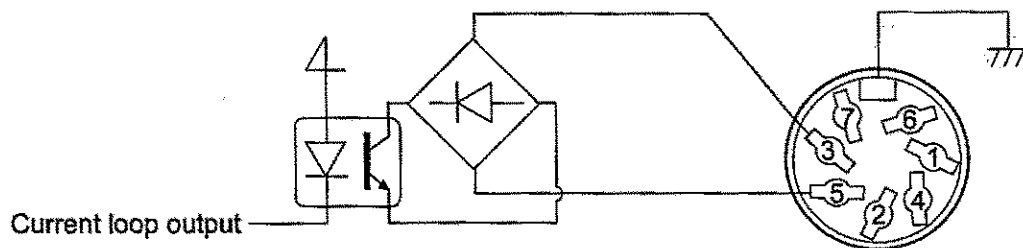

Pin assignments

GP-04

| Pin No. | Description |
|---------|------------------------------------|
| 1 | HI |
| 2 | COM |
| 3 | Sending loop (Current loop) |
| 4 | LO |
| 5 | Sending loop (Current loop) |
| 6 | OK |
| 7 | No connection |
| Housing | Shield |

GP-06

| Pin No. | Description |
|---------|------------------------------------|
| 1 | No connection |
| 2 | Analog GND |
| 3 | Sending loop (Current loop) |
| 4 | No connection |
| 5 | Sending loop (Current loop) |
| 6 | No connection |
| 7 | Analog output |
| Housing | Shield |

4-3 Connection to the AD-8121 Printer

Set the following parameters to use the AD-8121 printer.

| Function setting | Description |
|---------------------------------------|-----------------------------------------------|
| <i>dout Prt</i> 0-3 | Selects a print mode. |
| <i>dout RP-</i> P 0-2 | Selects the polarity for the auto print mode. |
| <i>dout RP-</i> b 0-2 | Selects the auto print difference. |
| <i>dout PUSE</i> 0,1 | Selects data output pause. |
| <i>S iF bPS</i> 2 Factory setting | 2400 bps |
| <i>S iF bPr</i> 0 Factory setting | 7 bits, Even parity check |
| <i>S iF CrLF</i> 0 Factory setting | CR, LF |
| <i>S iF Cts</i> 0 Factory setting | CTS and RTS control, not used |

| When "MODE 1" or "MODE 2" of the AD-8121 printer is used | |
|----------------------------------------------------------|---------------------|
| <i>S iF tYPE</i> 0 Factory setting | A&D standard format |

| When "MODE 3" of the AD-8121 printer is used. | |
|-----------------------------------------------|-----------|
| <i>S iF tYPE</i> 1 | DP format |

| When data is transmitted continuously. When all memory data is transmitted at one time. | |
|--------------------------------------------------------------------------------------------|-------------|
| <i>dout PUSE</i> 1 | Uses pause. |

AD-8121 Printer

- Compact thermal dot-matrix printer
- Statistical function, clock and calendar function, interval print function, graphic print function, terminal mode
- 5 x 7 dots, 16 characters per line
- Print paper (AX-PP143, 45 (W) x 50 (L) mm , ø65 mm)
- AC adapter or alkaline battery

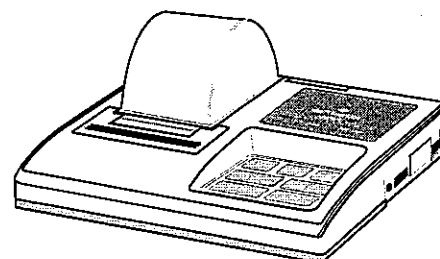

4-4 Description of the Item "Data output mode"

The parameter setting of the "Data output mode (*Prt*)" applies to the performance when the "Data memory (*dRtR*)" parameter is set to "2" (to store the weighing data) and when the data is transmitted using the RS-232C interface.

Key mode

When the **PRINT** key is pressed with the stabilization indicator turned on, the balance outputs or stores the weighing data and the display blinks one time.

Required setting *dout Prt* 0 Key mode

Auto print modes A and B

When the displayed value is stable and the conditions of "Auto print polarity", "Auto print difference" and reference value are met, the balance outputs or stores the weighing data.

When the **PRINT** key is pressed with the stabilization indicator turned on, the balance outputs or stores the data and the display blinks one time.

| | | | |
|--------------------------|-------------|--------------|--------------------------------------|
| Mode A: Required setting | <i>dout</i> | <i>Prt 1</i> | Auto print mode A (reference = zero) |
| | <i>dout</i> | <i>AP-P</i> | Auto print polarity |
| | <i>dout</i> | <i>AP-b</i> | Auto print difference |

Example "For weighing each time a sample is placed and removed, with "A-r-d" set to "1" (to adjust zero after the data is output)."

| | | | |
|--------------------------|-------------|--------------|------------------------------------------------------|
| Mode B: Required setting | <i>dout</i> | <i>Prt 2</i> | Auto print mode B (reference = last stable value) |
| | <i>dout</i> | <i>AP-P</i> | Auto print polarity |
| | <i>dout</i> | <i>AP-b</i> | Auto print difference |

Example "For weighing while a sample is added."

Stream mode

The balance outputs the weighing data continuously regardless of the display condition. The display does not blink in this mode. This mode is not available and the interval memory mode is used when the "Data memory (*dAtR*)" parameter is set to "2" (to store the weighing data).

| | | | |
|------------------|---------------|---------------|-----------------------------------|
| Required setting | <i>dout</i> | <i>Prt 3</i> | Stream mode |
| | <i>dout</i> | <i>dAtR 0</i> | Data memory function is not used. |
| | <i>bASFnC</i> | <i>SPd</i> | Display refresh rate |
| | <i>SIF</i> | <i>bPS</i> | Baud rate |

Example "For monitoring data on a computer"

Caution

The balance may not transmit the data completely at the specified refresh rate, depending on the baud rate or data added to the weighing data such as time, date and ID number.

Interval memory mode

The weighing data is periodically stored in memory.

| | | | |
|------------------|-------------|-------------------------|--------------------------------------------------------|
| Required setting | <i>dout</i> | <i>Prt 3</i> | Interval memory mode |
| | <i>dout</i> | <i>dAtR 2</i> | Data memory function is used. Stores weighing data. |
| | <i>dout</i> | <i>int</i> | Interval time |
| Optional setting | <i>dout</i> | <i>S-t d 1, 2, or 3</i> | Adds the time and date. |

Example "For periodical weighing without a computer command and to output all of the data, to a computer, at one time"

4-5 Description of the Item "Data format"

A&D standard format *SIF TYPE 0*

This format is used when the peripheral equipment can receive the A&D format. If an AD-8121 is used, set the printer to MODE 1 or 2.

- This format consists of fifteen characters excluding the terminator.
- A header of two characters indicates the balance condition.
- The polarity sign is placed before the data with the leading zeros. If the data is zero, the plus sign is used.
- The unit, consisting of three characters, follows the data.

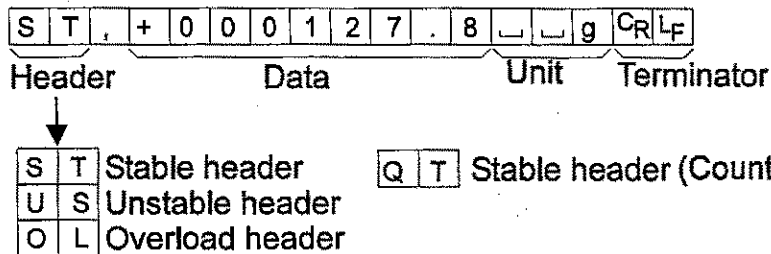

DP (Dump print) format *SIF TYPE 1*

This format is used when the peripheral equipment can not receive the A&D format. If an AD-8121 is used, set the printer to MODE 3.

- This format consists of sixteen characters excluding the terminator.
- A header of two characters indicates the balance condition. No overload header is used.
- The polarity sign is placed before the data, with spaces in place of leading zeros, if the data is not zero or overloaded.
- The unit, consisting of three characters, follows the data.

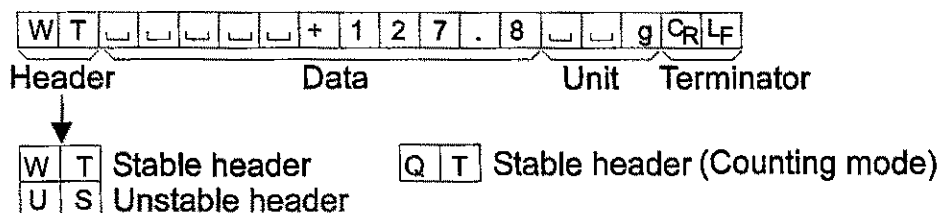

KF format *SIF TYPE 2*

This is the Karl-Fischer moisture meter format and is used when the peripheral equipment can only communicate using this format.

- This format consists of fourteen characters excluding the terminator.
- This format has no header characters.
- The polarity sign is placed before the data, with spaces in place of leading zeros, if the data is not zero or overloaded.
- This format outputs the unit only for a stable value.

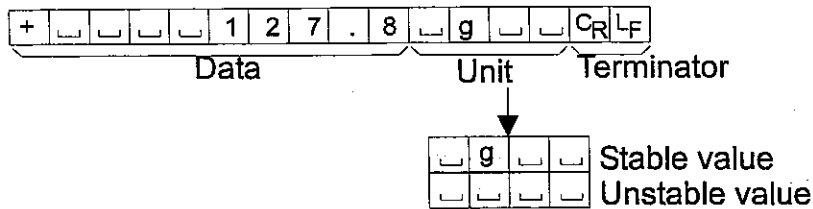

MT format *S, F TYPE 3*

- A header of two characters indicates the balance condition.
- The polarity sign is used only for negative data.
- The weighing data uses spaces in place of the leading zeros.
- The character length of this format changes dependent upon the unit

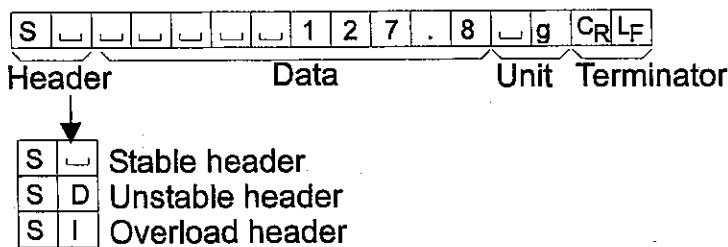

NU (numerical) format *S, F TYPE 4*

This format outputs only numerical data.

- This format consists of nine characters excluding the terminator.
- The polarity sign is placed before the data with the leading zeros. If the data is zero, the plus sign is used.

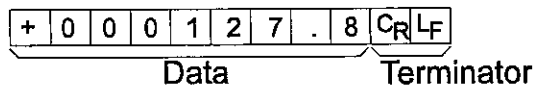

CSV format *S, F TYPE 5*

- Separates the data of A&D standard format and the unit by a comma (,).
- Outputs the unit even when the data is overloaded.
- When ID number, data number, time and date are added, outputs ID number, data number, date, time and weighing data in this order and separates each item by a comma and treats all the items as one group of data.

LAB-123,
 No,012,
 2001/12/31,
 12:34:56,
 ST,
 +000127.8,
 g <CR><LF>

ID number Data number Date Time Weighing data

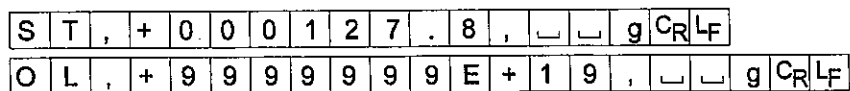

4-6 Description of the Data Format Added to the Weighing Data

ID number *dout S-id 1*

The number to identify a specific balance.

- This format consists of seven characters excluding the terminator.

| | | | | | | | | |
|---|---|---|---|---|---|---|----------------|----------------|
| L | A | B | - | 1 | 2 | 3 | C _R | L _F |
|---|---|---|---|---|---|---|----------------|----------------|

Data number *dout d-no 1*

This format outputs the data number just before the data is transmitted using the RS-232C interface.

- This format consists of six characters excluding the terminator.
- When CSV format (*SIF TYPE 5*) is selected, the period (.) is replaced with a comma (,).

| | | | | | | | |
|---|---|---|---|---|---|----------------|----------------|
| N | 0 | . | 0 | 0 | 1 | C _R | L _F |
|---|---|---|---|---|---|----------------|----------------|

Data number Terminator

Date *dout S-td 2 or 3*

- The date output order can be changed in "Clock (*CL ADJ*)". Outputs the year in four-digit format.

| | | | | | | | | | | | |
|---|---|---|---|---|---|---|---|---|---|----------------|----------------|
| 2 | 0 | 0 | 1 | / | 1 | 2 | / | 3 | 1 | C _R | L _F |
|---|---|---|---|---|---|---|---|---|---|----------------|----------------|

Time *dout S-td 1 or 3*

- Outputs time in 24-hour format.

| | | | | | | | | | |
|---|---|---|---|---|---|---|---|----------------|----------------|
| 1 | 2 | : | 3 | 4 | : | 5 | 6 | C _R | L _F |
|---|---|---|---|---|---|---|---|----------------|----------------|

Tare value *dout DATA 5*

- When the tare value in memory is recalled, the tare value is output before the weighing data.

| | | | | | | | | | | | | | | | | |
|---|---|---|---|---|---|---|---|---|---|---|---|---|---|---|----------------|----------------|
| P | T | , | + | 0 | 0 | 0 | 1 | 2 | 3 | . | 4 | □ | □ | g | C _R | L _F |
|---|---|---|---|---|---|---|---|---|---|---|---|---|---|---|----------------|----------------|

Comparison results

- By setting "Comparison results (*CP-r*)" of the function table to "I", the comparison results can be added to the data output using the RS-232C serial interface. Use A&D standard format (*TYPE 0*). The AD-8121 printer can not be used.

The comparison results are added after the header in A&D standard format as below.

| | | | | | | | | | | | | | | | | | | | |
|---|---|---|---|---|---|---|---|---|---|---|---|---|---|---|---|---|---|----------------|----------------|
| S | T | , | O | K | , | + | 0 | 1 | 2 | . | 3 | 4 | 5 | 6 | □ | k | g | C _R | L _F |
|---|---|---|---|---|---|---|---|---|---|---|---|---|---|---|---|---|---|----------------|----------------|

Header Comparison Data Unit Terminator
results

↓

| | | |
|---|---|----------------------------------|
| H | I | When the comparison result is HI |
| O | K | When the comparison result is OK |
| L | O | When the comparison result is LO |
| - | - | Not applicable |

Note

When the data described above is added to the weighing data, the output is in the following order: ID number, Data number, Date, Time and Weighing data.

4-7 Data Format Examples

Stable

° 12.7 9

| | | | | | | | | | | | | | | | | | | |
|-----|---|---|---|---|---|---|---|---|---|----------------|----------------|---|---|---|---|----------------|----------------|----------------|
| A&D | S | T | , | + | 0 | 0 | 0 | 0 | 1 | 2 | . | 7 | ␣ | ␣ | g | C _R | L _F | |
| DP | W | T | ␣ | ␣ | ␣ | ␣ | ␣ | ␣ | + | 1 | 2 | . | 7 | ␣ | ␣ | g | C _R | L _F |
| KF | + | ␣ | ␣ | ␣ | ␣ | ␣ | 1 | 2 | . | 7 | ␣ | g | ␣ | ␣ | ␣ | C _R | L _F | |
| MT | S | ␣ | ␣ | ␣ | ␣ | ␣ | ␣ | ␣ | 1 | 2 | . | 7 | ␣ | ␣ | g | C _R | L _F | |
| NU | + | 0 | 0 | 0 | 0 | 1 | 2 | . | 7 | C _R | L _F | | | | | | | |

Unstable

-1836.9 9

| | | | | | | | | | | | | | | | | | | |
|-----|---|---|---|---|---|---|---|---|---|----------------|----------------|---|---|---|---|----------------|----------------|----------------|
| A&D | U | S | , | - | 0 | 0 | 1 | 8 | 3 | 6 | . | 9 | ␣ | ␣ | g | C _R | L _F | |
| DP | U | S | ␣ | ␣ | ␣ | ␣ | - | 1 | 8 | 3 | 6 | . | 9 | ␣ | ␣ | g | C _R | L _F |
| KF | - | ␣ | ␣ | ␣ | 1 | 8 | 3 | 6 | . | 9 | ␣ | ␣ | ␣ | ␣ | ␣ | C _R | L _F | |
| MT | S | D | ␣ | ␣ | ␣ | - | 1 | 8 | 3 | 6 | . | 9 | ␣ | ␣ | g | C _R | L _F | |
| NU | - | 0 | 0 | 1 | 8 | 3 | 6 | . | 9 | C _R | L _F | | | | | | | |

Overload Positive error

E 9

| | | | | | | | | | | | | | | | | | |
|-----|---|---|---|----------------|----------------|---|---|---|---|----------------|----------------|---|---|---|---|----------------|----------------|
| A&D | O | L | , | + | 9 | 9 | 9 | 9 | 9 | 9 | 9 | E | + | 1 | 9 | C _R | L _F |
| DP | ␣ | ␣ | ␣ | ␣ | ␣ | ␣ | ␣ | ␣ | ␣ | ␣ | ␣ | ␣ | ␣ | ␣ | ␣ | C _R | L _F |
| KF | ␣ | ␣ | ␣ | ␣ | ␣ | ␣ | H | ␣ | ␣ | ␣ | ␣ | ␣ | ␣ | ␣ | ␣ | C _R | L _F |
| MT | S | I | + | C _R | L _F | | | | | | | | | | | | |
| NU | + | 9 | 9 | 9 | 9 | 9 | 9 | 9 | 9 | C _R | L _F | | | | | | |

Overload Negative error

-E 9

| | | | | | | | | | | | | | | | | | |
|-----|---|---|---|----------------|----------------|---|---|---|---|----------------|----------------|---|---|---|----------------|----------------|----------------|
| A&D | O | L | , | - | 9 | 9 | 9 | 9 | 9 | 9 | E | + | 1 | 9 | C _R | L _F | |
| DP | ␣ | ␣ | ␣ | ␣ | ␣ | ␣ | - | E | ␣ | ␣ | ␣ | ␣ | ␣ | ␣ | ␣ | C _R | L _F |
| KF | ␣ | ␣ | ␣ | ␣ | ␣ | ␣ | L | ␣ | ␣ | ␣ | ␣ | ␣ | ␣ | ␣ | ␣ | C _R | L _F |
| MT | S | I | - | C _R | L _F | | | | | | | | | | | | |
| NU | - | 9 | 9 | 9 | 9 | 9 | 9 | 9 | 9 | C _R | L _F | | | | | | |

- ␣ Space, ASCII 20h
- C_R Carriage Return, ASCII 0Dh
- L_F Line Feed, ASCII 0Ah

| Units | | A&D | D.P. | KF | MT |
|------------------------------|---------|------|------|--------|------|
| g | g | ┌┌g | ┌┌g | ┌g┌┌ | ┌g |
| kg | kg | ┌kg | ┌kg | ┌kg┌ | ┌kg |
| Counting mode | pcs | ┌PCS | ┌PCS | ┌pc s | ┌PCS |
| Precent mode | % | ┌┌% | ┌┌% | ┌%┌┌ | ┌% |
| Ounce (Avoir) | oz | ┌oz | ┌oz | ┌oz┌ | ┌oz |
| Pound | lb | ┌lb | ┌lb | ┌lb┌ | ┌lb |
| Pound Ounce | ┌oz | ┌oz | ┌oz | ┌oz┌ | ┌oz |
| Troy Ounce | ozt | ┌ozt | ┌ozt | ┌ozt | ┌ozt |
| Metric Carat | ct | ┌ct | ┌ct | ┌ct┌ | ┌ct |
| Momme | mom | ┌mom | ┌mom | ┌mom | ┌mo |
| Pennyweight | dwt | ┌dwt | ┌dwt | ┌dwt | ┌dwt |
| Tael (HK general, Singapore) | TL | ┌tl | ┌tl | ┌tl s | ┌tl |
| Tael (HK, jewelry) | TL | ┌tl | ┌tl | ┌tl h | ┌tl |
| Tael (Taiwan) | TL | ┌tl | ┌tl | ┌tl t | ┌tl |
| Tael (China) | TL | ┌tl | ┌tl | ┌tl c | ┌tl |
| Tola (India) | t | ┌┌t | ┌┌t | ┌t o l | ┌t |
| Messghal | MS | ┌mes | ┌mes | ┌MS┌ | ┌m |
| Density | DS | ┌DS | ┌DS | ┌DS┌ | ┌DS |
| Multi | (Blank) | ┌┌┌ | ┌┌┌ | ┌┌┌┌ | ┌ |

┌ Space, ASCII 20h

Note

When "Pound Ounce" is selected, the data is output with the unit of ounce (oz).

4-8 Connection to a Computer

The GP series balance is of the DCE type (Data Communication Equipment), which can be connected to a personal computer using the RS-232C interface.

Before connection, read the personal computer manual thoroughly.

Use a standard DCE cable for connection (cable type: straight-through).

When the personal computer type is a DOS/V with a 9-pin port, use a straight-through cable with a 25-pin male connector and a 9-pin female connector.

4-9 Using Windows Communication Tools (WinCT)

When Windows 95 or 98 is used as an operating system in a personal computer, the provided WinCT software can be used to transmit the weighing data to the personal computer.

The WinCT software has two communication methods: "RsCom" and "RsKey". For details on WinCT, refer to the WinCT instruction manual.

- RsCom**
- Can transmit commands to control the balance.
 - Can make bi-directional communication between the balance and a personal computer using the RS-232C interface.
 - Can display or store the data using a text file format. Can also print the data using a printer connected to the personal computer.
 - When several ports of a personal computer have balances connected, can communicate with each balance simultaneously.
 - Can share a personal computer with other application software.
 - Can receive the balance GLP report.

- RsKey**
- Can transmit the weighing data output from the balance directly to other application software such as Microsoft Excel.
 - Can be used with most application software.
 - Can receive the balance GLP report.

Note

Windows and Excel are registered trademarks of Microsoft Corporation.

4-10 Using the WinCT software, the balance can do the following:

- 1 Analyzing the weighing data and the statistics with "RsKey"
The weighing data can be input directly into an Excel worksheet. Then, Excel can analyze the data to obtain total, average, standard deviation, maximum and minimum value, and display them in a graph.
- 2 Controlling the balance using commands from a personal computer
By using "RsCom", the personal computer sends commands such as "re-zero" or "send weighing data" to the balance and controls the balance.
- 3 Printing the balance GLP report using your printer
The balance GLP report can be printed using a printer connected to the personal computer.
- 4 Receiving weighing data at a certain interval
The weighing data can be received at a certain interval and data characteristic with elapsed time can be obtained.
- 5 Using the GP series balance memory function
The data can be stored in the balance's memory. Of the data stored, the weighing data and calibration data can be transmitted to a personal computer at one time.
- 6 Using a personal computer as an external indicator
With the "RsKey" test mode function, a personal computer can be used as an external weight indicator for the balance. (To do this, set the balance data output mode to stream mode.)

4-11 Commands

Note

A command has a terminator added, that is specified using "SIF [rLF]" of the function table, and is sent to the balance.

| Commands to query weighing data | |
|--------------------------------------------------|--------------------------------------------------------------------------------------------------------------------------------------------------------------------------------------|
| C | Cancels the S or SIR command. |
| Q | Requests the weighing data immediately. |
| S | Requests the weighing data when stabilized. |
| SI | Requests the weighing data immediately. |
| SIR | Requests the weighing data continuously. |
| Commands to control the balance | |
| CAL | Same as the CAL key. |
| OFF | Turns the display off. |
| ON | Turns the display on. |
| P | Same as the ON:OFF key |
| PRT | Same as the PRINT key |
| R | Same as the RE-ZERO key |
| SMP | Same as the SAMPLE key. |
| U | Same as the MODE key |
| UN:mm | Recalls the unit mass values in memory. (mm indicates 01-50) |
| ?UN | Requests the unit mass numbers in memory. |
| UW:*****. * $\square\square$ g | Changes the unit mass value. (Only "g" is available as a unit.) Command e.g.: +002000.0 $\square\square$ g (Set the unit mass value to 2000.0 g: \square indicates a space.) |
| ?UW | Requests the unit mass value. |
| CN:mm | Recalls the upper/lower limit value in memory (mm indicates 01-20) |
| ?CN | Requests the upper/lower limit value code number of the selected value. |
| HI:*****. * $\square\square$ g | Sets the upper limit values. Command e.g.: HI:+002000.0 $\square\square$ g (To set the upper limit value to 2000.0 g: \square indicates a space.) |
| LO:*****. * $\square\square$ g | Sets the lower limit values. Command e.g.: LO:+001000.0 $\square\square$ g (To set the lower limit value to 1000.0 g: \square indicates a space.) |
| ?HI | Requests the upper limit value. |
| ?LO | Requests the lower limit value. |
| PN:mm | Recalls the tare value in memory. (mm indicates 01-20) |
| ?PN | Request the tare number of the selected value. (mm indicates 01-20) |
| PT:*****. * $\square\square$ g | Sets the tare value. Command e.g.: PT:+001000.0 $\square\square$ g (To set the tare value to 1000.0 g: \square indicates a space.) |
| ?PT | Request the tare value. |
| MCL | Deletes all data in memory. |
| MD:nnn | Deletes data with the data number nnn. |
| ?MA | Outputs all weighing data in memory. |
| ?MQnnn | Outputs data with the data number nnn. |
| ?MX | Outputs the number of data in memory (the last data number) |

Notes

When a unit is required in commands such as a "PT:" command, use the 3-digit unit code of the A&D standard format.

nnn indicates a three-digit numerical value.

4-12 Acknowledge Code and Error Codes

When the "Serial interface function (*S i F*)" parameter is set to "ErCd 1", the balance outputs <AK> code or error code to each command as follows:

<AK> (06h) Acknowledge in ASCII code.

- When the balance receives a command to request data and can not process it, the balance transmits an error code (EC, Exx).

When the balance receives a command to request data and can process it, the balance outputs the data.

- When the balance receives a command to control the balance and can not process it, the balance transmits an error code (EC, Exx).

When the balance receives a command to control the balance and can process it, the balance transmits the acknowledge code.

Among commands to control the balance, the following transmit the acknowledge code both when the balance receives the command and when the balance has accomplished the command. If the command can not be processed properly, the balance transmits an error code (EC, Exx). This error can be released using the CAL command.

CAL command (Calibration command) ON command (Display ON command)

P command (Display ON/OFF command) R command (RE-ZERO command)

- When a communication error has occurred due to external noise, or a parity error has occurred due to transmission error, the balance transmits an error code. In this case, send the command again.

4-13 Control Using CTS and RTS

Depending on the "CTS" parameter of "Serial interface (*S i F*)", the balance performs as follows:

CTS 0

Regardless of whether the balance can receive a command or not, the balance keeps the CTS line Hi. The balance outputs data regardless of the condition of the RTS line.

CTS 1

The CTS line is kept Hi normally. When the balance can not receive the next command (e.g. while the balance is processing last command), the balance sets the CTS line to Lo. The balance confirms the level of the RTS line before outputting a set of data. If the RTS level is Hi, the balance outputs data. If the RTS level is Lo, data is not output (The data is canceled).

4-14 Settings Related to RS-232C

Concerning the RS-232C, the balance has two functions: "Data output (*dout*)" and "Serial interface (*S i F*)". Set each function as necessary.

5. ANALOG OUTPUT (GP-06)

5-1 Installing the GP-06 Option

Install the GP-06 option in the following procedures:

1. Remove the option cover, then remove the RS-232C board.

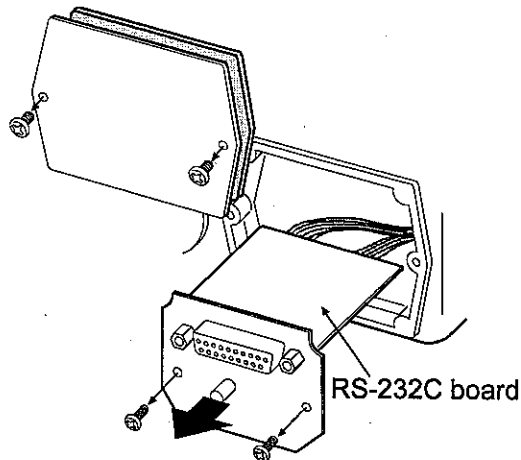

2. Turn the board over so that the connectors can be accessed.
Remove the connectors from the RS-232C board.
They are difficult to remove, so use care.

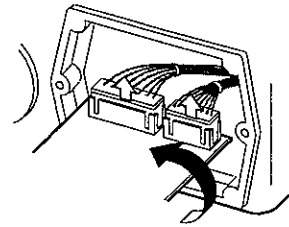

3. Connect the cables, removed from the RS-232C board, to the GP-06 board.

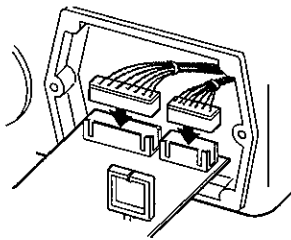

4. Secure the cables in the wire clip.

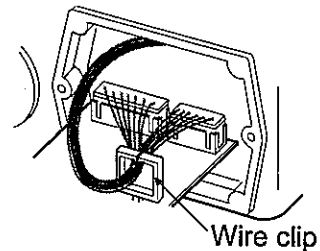

5. Turn the GP-06 board over so that the connectors face downward.
Insert the board into the display casing.
When inserting, lower the edge of the GP-06 board so that the GP-06 board will not touch the board located in the upper side of the casing.
Fasten the GP-06 panel with screws.

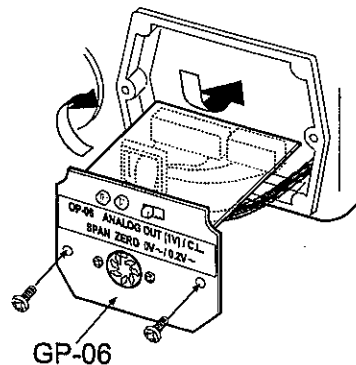

5-2 Analog Output (GP-06) Specifications

The specifications of the analog output unit (GP-06) are as follows:

| | |
|-----------------------------------------|--------------------------------------------------------------------------------------------------|
| Output impedance | 100 Ω or less |
| Linearity | $\pm 0.3\%$ or less |
| Output connector | 7-pin DIN connector |
| Pin connections | Output Pin 7 GND Pin 2 |
| Output range | 0 V-1 V (With the slide switch set to "0V~") 0.2 V-1 V (With the slide switch set to "0.2V~") |
| Input impedance of the device connected | 10 k Ω or greater |

Circuit

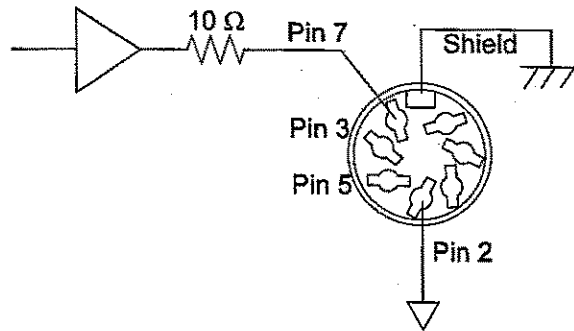

Current loop output specifications

The specifications of the current loop interface are as follows:

(For details, see "4-2 Current Loop Output (GP-04/GP-06) Specifications" on page 17.)

| | |
|---------------------|-------------------------------------------------------|
| Transmission system | 20 mA current loop (Passive) |
| Transmission | Asynchronous, uni-directional (Only from the balance) |
| Data format | Baud rate: 600, 1200, 2400, 4800, 9600 19200 bps |
| | Data: 7 or 8 bits |
| | Parity: Even, Odd (Data 7 bits) None (Data 8 bits) |
| | Stop bit: 1 bit or 2 bits |
| | Code: ASCII |

| Data | Current loop (20 mA) |
|------|----------------------|
| 1 | 20 mA |
| 0 | 0 mA |

Notes

To use current loop, an external power supply that provides 20 mA is required.

The maximum rated voltage of the current loop is 25 V.

When a baud rate of 4800 bps or higher is used, communication may not be performed properly.

Pin assignments

| Pin No. | Description |
|---------|-------------------------|
| 1 | No connection |
| 2 | Analog GND (0 V) |
| 3 | Sending loop |
| 4 | No connection |
| 5 | Sending loop |
| 6 | No connection |
| 7 | Analog output |
| Housing | Shield |

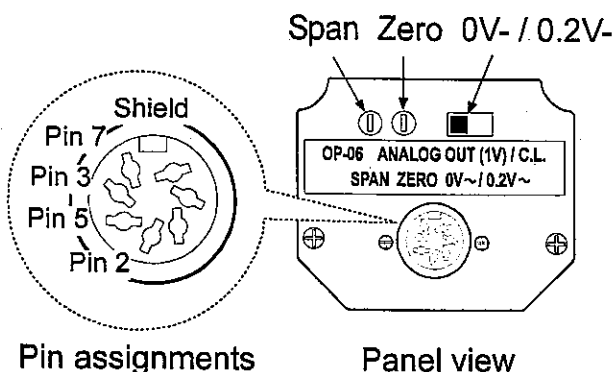

5-3 Analog Output (R_{out})

The "Analog output (R_{out})" of the function table can be selected when the GP-06 option is installed in the balance.

Analog output function table

| Item | Parameter | Description |
|---------------------------------|--------------------------------------|-------------------------------------------------------------------------------------------------------------------------------------------------------------------------------------------------------------------------------------------------------------------------------------------------------------------------------------|
| R_n Analog output mode | 0 | 2-digit output Converts the consecutive 2 digits, with the digit selected in SEL as the least, to voltage and outputs. |
| | 1 | 3-digit output Converts the consecutive 3 digits, with the digit selected in SEL as the least, to voltage and outputs. |
| | ▪ 2 | Net full scale output Outputs 0.000 V when the net weight is zero. Outputs 1.000 V when the net weight is full scale. Outputs 0.000 V when the display is set to zero using the RE-ZERO key. |
| | 3 | Gross full scale output Outputs 0.000 V when the gross weight is zero. Outputs 1.000 V when the gross weight is full scale. Tare operation using the RE-ZERO key will not affect the output. (Note: If the tare is extremely light, tare operation might change the zero point, thus it will affect the output.) |
| SEL Output digit selection | | Select the least digit to be output in the mode selected in R_n . Only available when 0 or 1 is selected as the output mode. |
| | ▪ 0 | Select the first digit as the least. |
| | 1 | Select the second digit as the least. |
| | 2 | Select the third digit as the least. |
| | 3 | Select the fourth digit as the least. |
| | 4 | Select the fifth digit as the least. |
| 5 | Select the sixth digit as the least. | |

▪ Factory setting

Setting example

When $R_n 0$ is set:

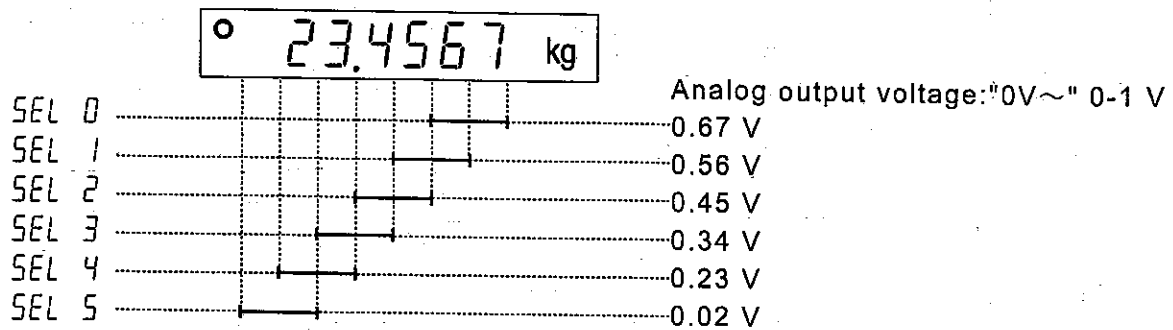

Notes

The invisible high-order digits are regarded as zero.

The invisible least digit is regarded as zero (when the minimum weighing value is turned off using the **SAMPEL** key).

When $R_n 1$ is set:

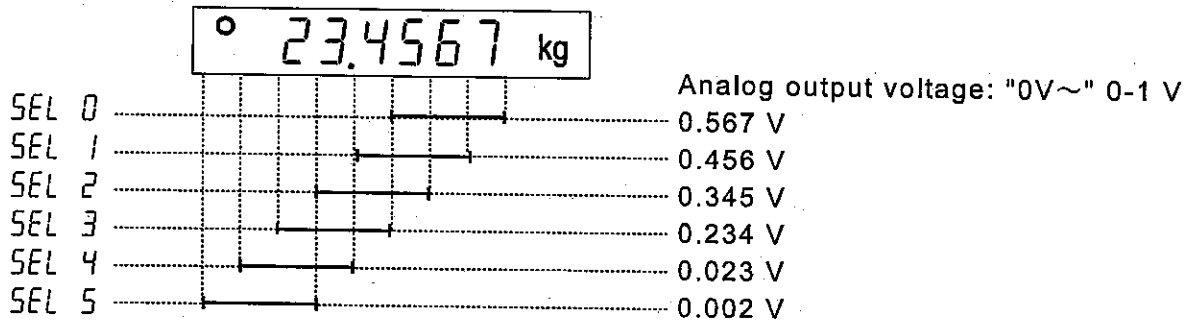

When $R_n 2$ or $R_n 3$ is set:

| Model | Full scale |
|---------------|------------|
| GP-12K | 12 kg |
| GP-20K | 20 kg |
| GP-22K | 20 kg |
| GP-30K/30KS | 30 kg |
| GP-40K | 40 kg |
| GP-60K | 60 kg |
| GP-100K/100KS | 100 kg |
| GP-102K | 100 kg |

For example, when the GP-20K displays 2 kg, the output voltage of $R_n 2$ is 0.1 V (when the slide switch is set to "0V~").

$$1.000 \text{ V} \times \frac{2 \text{ kg}}{20 \text{ kg}} = 0.100 \text{ V}$$

Note

"Full scale" of the full scale output mode indicates the full scale values shown in the table above. The output voltage may exceed 1.000 V, depending on the weighing data.

For example, when the GP-20K displays 21 kg, the output voltage is 1.05 V.

$$1.000 \text{ V} \times \frac{21 \text{ kg}}{20 \text{ kg}} = 1.05 \text{ V}$$

5-4 Switching Output Voltage

The output voltage can be switched using the slide switch on the GP-06 panel. "0V~" has been set at factory before shipment.

| | | | | |
|--------------------|---------|---------|---------------|---------|
| "0V~" (0-1 V): | At zero | 0.000 V | At full scale | 1.000 V |
| "0.2V~" (0.2-1 V): | At zero | 0.200 V | At full scale | 1.000 V |

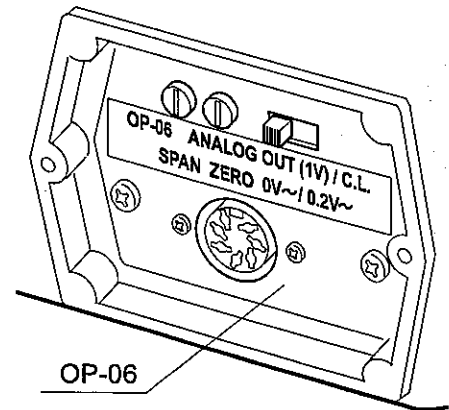

5-5 Output Voltage Fine Adjustment

The output voltage has been adjusted at the factory before shipment.

Using the ZERO and SPAN fine-adjustment knobs and a voltmeter, output voltage can be fine adjusted.

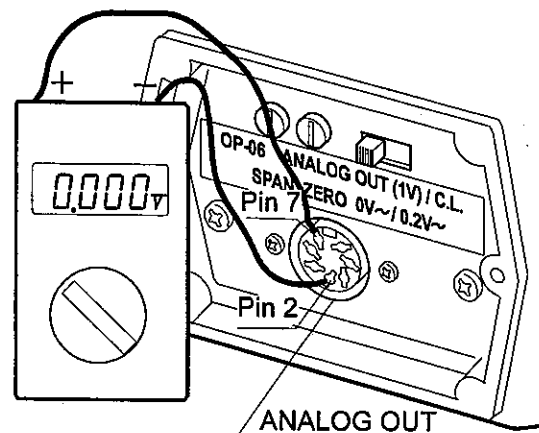

Fine-adjustment procedure

1. Turn the display off, using the **ON:OFF** key. At this time, the output voltage will be at zero. Turn the ZERO knob so that the voltmeter indicates 0.000 V when the slide switch is set to "0V~"; 0.200 V when the slide switch is set to "0.2V~".
2. While pressing and holding the **SAMPLE** and **PRINT** keys, press the **ON:OFF** key. The balance displays **P5**. At this time, a voltage of 1 V is generated. Turn the SPAN knob so that the voltmeter indicates 1.000 V.
3. Repeat steps 1 and 2 until the correct output voltage is obtained.

Display for setting the output to 0 V (0.2 V)



Display for setting the output to 1 V



5-6 Fixed Output Voltage

The output voltage is fixed under the following conditions:

1. During operations other than weighing (e.g., the display-off state, calibration) :0 V (or 0.2 V)
2. During the zeroing operation / $R_n \exists$:The previous output value is retained.
 $R_n 0 / R_n 1 / R_n 2$:0 V (or 0.2 V when the slide switch set to "0.2V~")
3. When "-E" (Weighing pan error) is being displayed: :0 V (or 0.2 V when the slide switch set to "0.2V~")
4. When "E" (Overload error) is being displayed: :Output voltage is as shown below.
 (when the slide switch is set to "0V~")

| Model | $R_n 2, R_n 3$ |
|---------------|----------------|
| GP-12K | 1.000 V |
| GP-20K | 1.050 V |
| GP-22K | 1.050 V |
| GP-30K/30KS | 1.033 V |
| GP-40K | 1.025 V |
| GP-60K | 1.018 V |
| GP-100K/100KS | 1.010 V |
| GP-102K | 1.010 V |

