

INSTRUCTION MANUAL

Assembled Scales:

MODELS: FV-15OKA1
FV-6OKA1
FV-6OKA2
FV-3OKA2
FV-15OKWP
FV-6OKWP
FV-3OKWP
FV-15OKSP
FV-6OKSP
FV-3OKSP

Display Pod &
Load Cell Kits:

FV-15OKK1
FV-6OKK1
FV-6OKK2
FV-3OKK2

A&D *Mercury*
PTY.LTD.

A&D MERCURY PTY. LTD.
32 Dew St, Thebarton, S.A., 5031

Telephone (08) 3523033

Facsimile (08) 3527409

CONTENTS

Introduction	Page 3
Specifications	Page 4
Installation	Page 4
Understanding your Scale	Page 5
Best Conditions for Weighing	Page 5
Understanding the Display	Page 6
Auto Power Off Function	Page 8
Zero Calibration	Page 9
Simple Weighing	Page 10
Counting Mode	Page 11
Comparator Mode	Page 12
The Optional RS-232C Interface	Page 14
Comparator	Page 15
Weighing Units	Page 16
Installing Option OP-01, OP-02	Page 17
Installing Remote Switch	Page 17

INTRODUCTION

Thank You For Your Purchase of an A&D Scale

The FV, FV-SP & FV-WP series of high resolution multi-function platform scales are the product of years of research, design, development and in-field testing. They incorporate the latest advances in electronic and mechanical engineering and offer increased features and increased functions all at a reduced cost. This manual will try to tell you in simple language how this scale works and how to get the most out of it in terms of performance.

The FV, FV-SP & FV-WP scales may be operated on six UM2 ('C' type) 1.5V dry batteries, or on rechargeable batteries of the same size (using an external charger). Continuous operation will be possible for between 100 to 150 hours on one set of batteries at 20°C/68°F. The Display Pod viewing angle is adjustable, and it can be removed for use as a desk top, or wall mounted weighing indicator (the Display Arm is also removable - however, the FV-WP comes with no Display Arm, but with a standard non-adjustable wall mount. An adjustable wall mount is optional for the FV & FV-SP).

The FV & FV-SP Display Pod viewing angle is adjustable, and it (along with the Display Arm) can be removed for use as a desk top, or wall mounted weighing indicator using the optional adapter kits. The FV-WP does not come with a Display Arm (one is available as an option OP-12), but comes with a standard non-tilting wall mount.

Battery operation permits the scale to be operated anywhere. The weighing platform is of a rugged washdown stainless steel type, and the FV-WP Stainless Steel Display Pod enclosure also permits washdown. The scale's unit conversions are from decimal pounds to kilograms and vice versa. The tare range is from zero to maximum capacity. There is also a counting function for counting up to 3,000 pieces. The check weighing display has "HI", "GO", and "LO" (LCD type annunciators), with two setpoints available for setting "HI" and "LO" limits. When the optional RS-232C Interface is installed a comparator buzzer can be heard and relay output control becomes possible via the 1st, 2nd, 4th and 6th pins of the 7-pin DIN output connector. The A/D converter is highly accurate and there is complete RFI shielding for the analog section.

Options include:

- OP-01 ... Wall Mounting Kit (tilting bracket) – not for FV-WP.
- OP-02 ... 5m/16.4ft Display Pod extension cable.
- OP-03 ... RS-232C and comparator buzzer/relay board – not for FV-WP.
- OP-05 ... AC adaptor AC100~120V. "A" type plug (2-pin/flat).
- OP-06 ... AC adaptor AC200~240V. "C" type plug (2-pin/round).
- OP-07 ... AC adaptor AC200~240V. "BF" type plug (3-pin/square).
- OP-08 ... AC adaptor AC200~240V. Without any plug.
- OP-09 ... AD-8117 cable & Display Pod mounting plate – not for FV-WP.
- OP-10 ... AC adaptor AC200~240V. "S" type plug (3-pin/flat).
- OP-11 ... FV-WP RS-232C and comparator buzzer/relay board.
- OP-12 ... FV-WP Display Arm.

SPECIFICATIONS

Model	FV-150KA1 FV-150KA1/SP/WP	FV-60KA1 FV-60KA1/SP/WP	FV-60KA2	FV-30KA2 FV-30KA2/SP/WP
Capacity kg	150kg	60kg	60kg	31kg
Resolution kg	50g	20g	20g	10g
Capacity lb	300lb	120lb	120lb	60lb
Resolution lb	0.1lb	0.05lb	0.05lb	0.02lb
Capacity oz	4,800oz	1,920oz	1,920oz	960oz
Resolution oz	2oz	1oz	1oz	0.5oz
Calibration weight kg	150kg or 100kg	60kg or 40kg	60kg or 40kg	30kg or 20kg
Calibration weight lb	300lb or 200lb	120lb or 80lb	120lb or 80lb	60lb or 40lb
Pan size mm	390mm x 530mm	390mm x 530mm	326mm x 420mm	326mm x 420mm
Pan size inches	15.4in x 20.8in	15.4in x 20.8in	12.8in x 16.5in	12.8in x 16.5in
Weight	17kg/37.5lb	17kg/37.5lb	12kg/26.5lb	12kg/26.5lb
Power	9V DC from 6 x UM2/ 'C' size batteries or optional AC adaptor			
Battery life	100~150 hrs at 20°C/68°F depending of type of battery			
Operating temperature	-5°C~35°C/23°F~95°F			
Maximum count	3000 at min. unit weight (which equals display resolution)			
Sample size	5,10,20,50,100 pieces (set at 5, selectable with HI/LO key)			
Check weight	Two setpoints with "HI", "GO", "LO" liquid crystal annunciators			

Specifications subject to change for improvement without notice.

INSTALLATION

- MODELS: • FV-150KA1, • FV-60KA1, • FV-60KA2, • FV-30KA2
• FV-150KSP, • FV-60KSP, • FV-30KSP.
• FV-150KWP, • FV-60KWP, • FV-30KWP.
 - Unpack the assembled or unassembled scale carefully and keep the packing material if you are likely to want to transport the scale again in the future.
 - In the carton you should find this manual, ASSEMBLY INSTRUCTIONS *plus*:
 - Weighing Platform Base.
 - Four screw-type feet.
 - Weighing Pan.
 - Display Pod.
 - FV Display Arm - or for the FV-WP, a Wall/Desk Mount.
 - Six UM-2/'C' size Batteries.
 - Assorted lock screws and sealing plates for Display Pod
 - Display Pod Waterproof Cover.*
 - Four hex bolts and hex wrench (to tighten the Display Arm hex bolts).*
 - Two black self-adhesive plastic cable clips for Display Arm.*
 - Mini 2-channel jack plug for remote TARE and ZERO.*
- *Not included with the FV-WP series scales.
- Place the assembled scale on a firm weighing table, or flat floor and turn the adjustable feet until the bubble level shows that the scale is level. Install the pan on the scale, insert the batteries and plug in the AC/DC adaptor if used. The DC output should be 9 Volts (please note that an alternative 9V DC power supply might not be stable enough for this scale).

UNDERSTANDING YOUR SCALE

How does the scale work?

When you put an object on the weighing pan it is pulled downwards under the action of gravity. This scale operates using a highly accurate and sensitive Load Cell. Load Cells work by detecting stress in the cell (a carefully machined metal bar) by means of strain gauge transducers bonded to the upper and lower surfaces. As the Load Cell bends, the analog output signal from the strain gauge varies. This signal is amplified and used as the input signal for an analog to digital converter. The final digital signal is used to calculate the weight for the display. In future we will call the object a "mass" and the measurement of its massiveness on Earth its "weight" (weight=mass times acceleration due to "g").

What is gravity?

Gravity is a force of attraction between material objects in space. The Earth is a large material object (mass) in space and things on its surface at sea level, in a vacuum, accelerate towards its center at a speed of about 9.80665m/s² (32.174ft/s²). Fortunately they don't get there because the surface of the Earth stops them. Unfortunately, this "g" value varies from location to location by about ±0.3% because the force decreases with altitude above sea level or, more correctly, the distance from the center of the Earth ("g" is inversely proportional to the square of the distance between masses). The North and South poles are closer to the center of the Earth than the equator so "g" is greater at the poles and changes with latitude. The sun and the moon have an inconsistent effect with regards to gravity. Air buoyancy acts against gravity by making a mass float upwards at a rate of ≈ 0.0012g (±10% @ 20°C) per cm³ of air displaced, but this also varies.

What is calibration?

When we weigh a mass we are trying to find its weight expressed as pounds or kilograms. Because "g" and other factors vary from location to location, we must calibrate the scale whenever we move it otherwise a mass of 30lb might display 30.00lb in one location and 30.08lb in another (ie: "g" may have changed by +0.267%. $w=m \times g$). This would be an error but it can be prevented by placing an accurate mass on the scale (say 30lb) and then telling the scale, in effect, "this is what 30lb weighs at this location so please display 30.00lb" - this is calibration.

Note: If this scale is used as a commercial scale, then the end user may not be permitted to calibrate it. In this case, calibration would be carried out by the responsible authorities, and the calibration settings would then be sealed. Recalibration should be carried out every six months, or if the scale is moved a substantial distance.

Best Conditions For Weighing

- The Scale must be level (check the bubble level under the pan).
- Best temperature is about 20°C/68°F at about 50% Relative Humidity.
- The weighing table should be of a solid construction.
- Corners of rooms are best as they are less prone to vibrations.
- Don't install the scale in direct sunshine.
- Try to ensure a stable AC power supply when using an adaptor.
- Clean the scale with mild soap and water (don't use solvents).

UNDERSTANDING THE DISPLAY

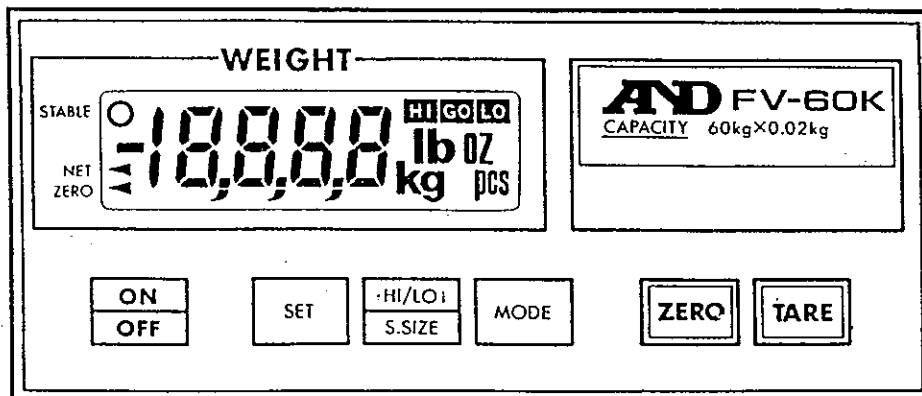

The FV, FV-SP & FV-WP scales use a sharp, 17mm high LCD display. You can make sure that all the display segments are working properly by pressing the ON/OFF key.



The ON/OFF Key

After pressing the ON/OFF key, you will see all segments appear for a couple of seconds. (Note: In some countries "lb", "oz" or "pcs" will not be available)

- Starting at the left end of the display you will see a circular stability indicator, a minus weight display symbol, a triangular NET indicator and ZERO indicator. Next you can see the main display "18.8.8.8".
- On the upper right you will see the abbreviations "HI", "GO", "LO" for the comparator. Below those are displayed "lb", "kg", "oz", or "pcs".
- After a few moments the circular stability indicator, zero indicator, main display (reading zero) and a unit ("lb", "kg", "oz", or "pcs") will remain.
- The scale will switch off automatically if the display remains at zero for three minutes, but this function can be deactivated.
- Also, "Lb" will be displayed on the main display if the power in the batteries is too low for reliable weighing and "E" ("lb", "kg", "oz", or "pcs") will be displayed if the scale is overloaded.



The SET Key

To the right of the ON/OFF key is the SET key. The SET key has three different uses:

- 1) In the Weighing Mode, it is pressed to activate or deactivate the comparator function (If the comparator has been deactivated, it will not be possible to access the high and low setpoint values with the **MODE** (or **UNITS**) key).
- 2) In the Counting Mode ("pcs"), it is pressed to register the unit weight of the sample (5, 10, 20, 50 or 100 pieces) in non-volatile memory.



The HI/LO-S.SIZE Key

Next to the SET key is the HI/LO-S.SIZE key, it has two different uses:

- 1) In the Comparator Mode, it is used to input setpoint values in conjunction with the SET key.
- 2) In the Counting Mode the sample size is normally 5, but by pressing HI/LO-S.SIZE you may select a sample size of 10, 20, 50 or 100 pieces.



The MODE (or UNITS) Key

Next, this key may be labeled MODE or UNITS depending on the model and location. It also has two different functions:

- 1) The MODE (or UNITS) key can be used to change the units in the following sequence: "lb" → "oz" → "kg" → "pcs" → "HI" → "LO". *Note: HI and LO are displayed only when the Comparator function is on (they are for setting the high/low setpoint limits when the scale is acting as a check weigher).*

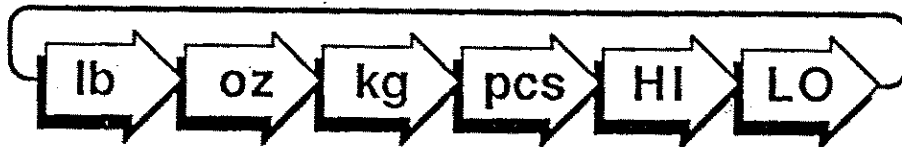

- 2) When the Comparator function is on (HI and LO setpoints are entered) the MODE (or UNITS) key can be used to set the values of these settings.



The ZERO Key

The ZERO key returns the scale to the center of zero when the weighing pan is empty, and should not be confused with the TARE key which re-zero's the display and places the scale in NET mode.

When the display shows a small deviation from zero and the weighing pan is empty (and the tare function is not being used), then press the ZERO key to return the display to "0.00". If there is a large deviation from zero, then there may be something else wrong, like the weighing pan touching something.

If "----" is displayed when the power is turned on, or if the ZERO key will not set the display to zero, then you should carry out ZERO CALIBRATION (see page 9)



The TARE Key

The TARE key re-ZERO's the display up to the maximum capacity of the scale, places the scale in NET mode, and should not be confused with The ZERO key which returns the scale to the center of zero when the weighing pan is empty. The TARE weight (container weight) subtracts from the range of the scale.



AUTOMATIC POWER OFF FUNCTION

The FV, FV-SP & FV-WP scales comes with an *automatic power-off function* which turns the main display off after three minutes to conserve battery power. It only works if the display shows "0.00" - any other reading and the scale will remain on. You can temporarily disable this function by:

- Placing an object on the weighing pan,
- Setting the Tare function so the display shows a negative number when an object is removed from the weighing pan (after the object's weight is set as a Tare).

You can also turn **OFF** the Automatic Power-Off Function using the software. By doing this, the scale will always remain **on** until it is turned off using the **ON/OFF** key. You can reactivate this function at any time.

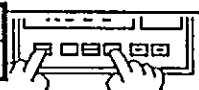
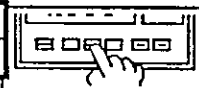
To turn OFF the Automatic Power-Off Function (until reactivated):

Step 1.	Turn the display OFF .	
Step 2.	<div style="display: flex; align-items: center;"> <div style="border: 1px solid black; padding: 2px; margin-right: 5px;">MODE*</div>  </div> <div style="font-size: 8px; margin-top: 2px;">* or units</div>	Press and hold the MODE (or UNITS) key.
Step 3.	<div style="display: flex; align-items: center;"> <div style="border: 1px solid black; padding: 2px; margin-right: 5px;">ON OFF</div>  </div>	While holding the MODE (or UNITS) key, press the ON/OFF key.
DISPLAY	<div style="border: 1px solid black; padding: 5px; width: 100px; margin: 0 auto;">F0 1</div>	will be displayed, which means the display will cut OFF after three minutes.
Step 4.	<div style="display: flex; align-items: center;"> <div style="border: 1px solid black; padding: 2px; margin-right: 5px;">HI/LO S.SIZE</div>  </div>	Press the HI/LO key.
DISPLAY	<div style="border: 1px solid black; padding: 5px; width: 100px; margin: 0 auto;">F0 0</div>	will be displayed, which means the automatic power-off function is now disabled.
Step 5.	<div style="display: flex; align-items: center;"> <div style="border: 1px solid black; padding: 2px; margin-right: 5px;">ZERO</div>  </div>	Press the ZERO key.
DISPLAY	<div style="border: 1px solid black; padding: 5px; width: 100px; margin: 0 auto;">End</div>	You have now disabled the function.
Step 6.	<div style="display: flex; align-items: center;"> <div style="border: 1px solid black; padding: 2px; margin-right: 5px;">ON OFF</div>  </div>	Press ON/OFF twice to return to normal weighing mode.
Note:	<i>The automatic power-off function is now disabled - the scale will remain ON until turned off.</i>	

To reactivate :

To reactivate the automatic power-off function, follow the above steps, but enter "F0 1" with the **HI/LO** key in Step 4.

ZERO CALIBRATION

Although the end user may not be permitted to carry out span calibration, he may carry out zero calibration by following the procedure below.

Zero calibration is needed if ---- is displayed when the power is turned on, or when the **ZERO** key will not set the display to zero.

Step 1. Remove all objects from the Weighing Pan and turn the display **ON**.

Step 2.  Press the **MODE** (or **UNITS**) key and **ZERO** key simultaneously.
* or units

DISPLAY CAL 0

Step 3.  Press the **ZERO** key and the zero point will be entered.

DISPLAY The display will then return to normal weighing mode.

NOTE: For span and gravity compensation calibration, with reference to global altitude and latitude, please see the booklet "FV, FV-SP & FV-WP CALIBRATION INSTRUCTIONS" (this may not be available for some commercial users).

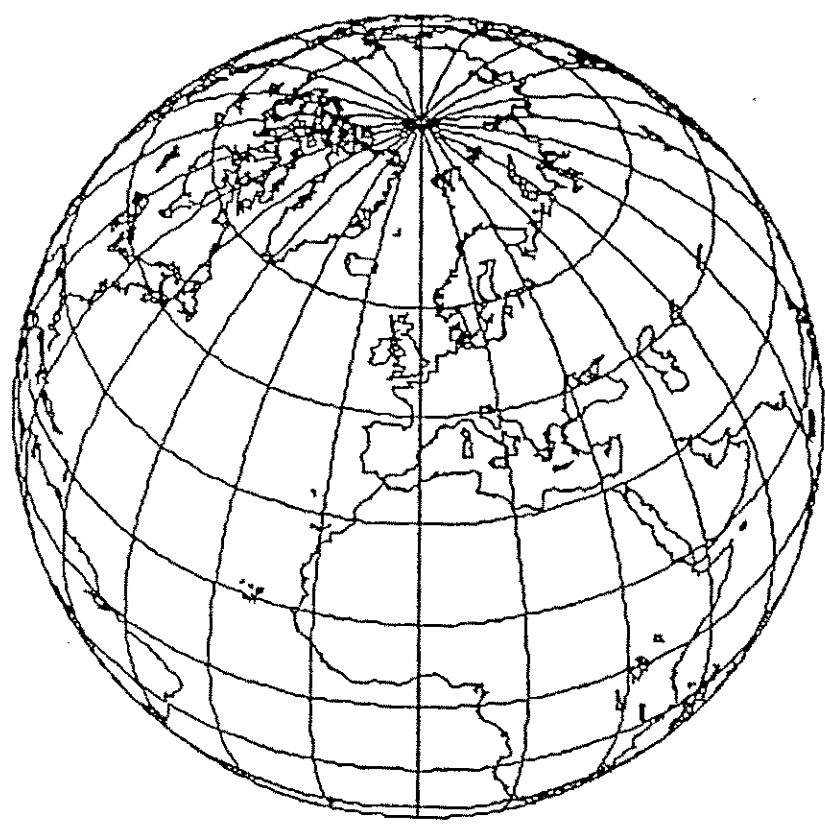

SIMPLE WEIGHING

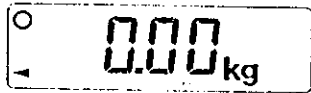
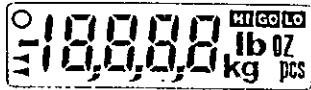

FV Series

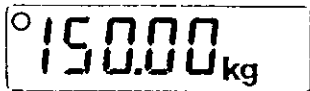
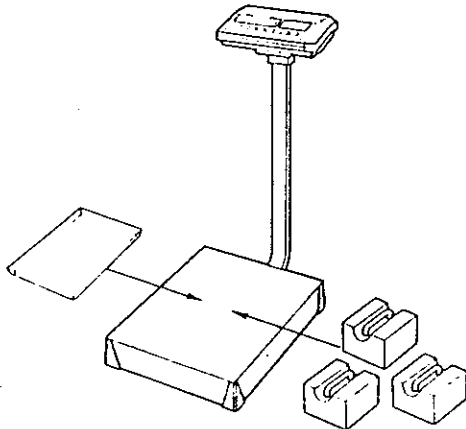

FV-WP Series

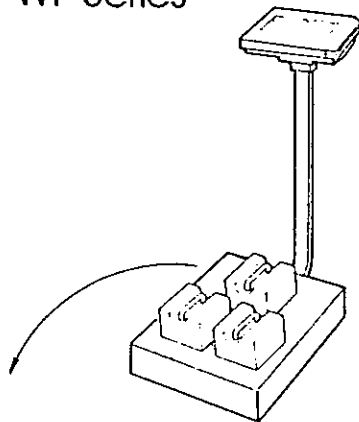

Simple Weighing

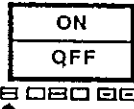
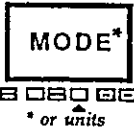
- 1)  Turn the display on via the ON/OFF key.
- 2)  Weigh in kilograms or select a different mode with the MODE (or UNITS) key.
* or units
- 3) Place the object(s) on the pan and read the weight when stable.

Weighing into a Container

- 1) Place the container on the pan.
- 2)  Press TARE to cancel the weight.
- 3) Fill the container until the target weight is reached. When adding more than one ingredient to the container, press TARE after each one.

Weighing out of a Container

- 1) Place the full container on the pan.
- 2)  Press TARE to cancel the weight.
- 3) Scoop the amount of material you need out of the container with reference to the negative display.

Devotional Weighing

- 1) Place a reference object on the pan.
 - 2)  Press TARE to cancel the weight.
- Comparative objects placed on the pan will now show their deviation from the reference weight (zero) in terms of a \pm weight display.

COUNTING MODE

"pcs"

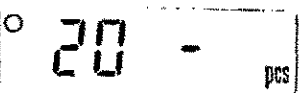
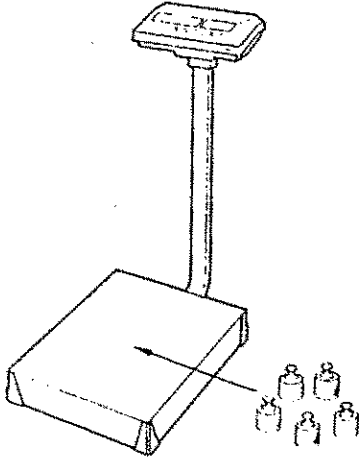
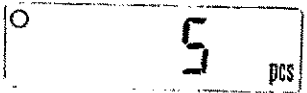
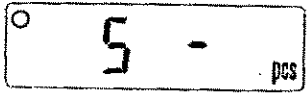

1) Weigh one unit of what is to be counted. If it is too small for the scale to detect ("0" stays displayed) then it is also too small to use with Counting Mode. We suggest in this case that you use 10 units and count them as one "pcs". So, a sample size of 5 pcs would be 50 units.

2)  Select "pcs" with the **MODE** (or **UNITS**) key.
* or units

3)  Press **ZERO** to zero the display.

4)  Press the **SET** key and "5 0 pcs" will be displayed. Place 5 units on the pan and the display will read "5 - pcs".

5)  Press the **SET** key again.

- Having established the unit weight of the parts you are counting, you may now count up to 3,000 pieces.

Note: The maximum capacity of FV, FV-SP & FV-WP scales in "pcs" mode is 3,000 pcs

- If 5 units is not enough weight, the display will show "Lo" when you press the **SET** key. This means that the unit weight is less than the scale can detect (see above).

- You can also use the **HI/LO-S.SIZE** key to display 10, 20, 50 or 100 units as a sample. As a rule, the higher the sample size, the more accurate the count, so use the largest sample size that is convenient for you.

Note: You should only use the Counting Mode to count pieces of the same weight.

COMPARATOR MODE

"HI", "GO", "LO"

The Comparator Mode can be used with "lb", "kg", "oz", or "pcs". The user should set the acceptable range - the highest limit acceptable, then the lowest.

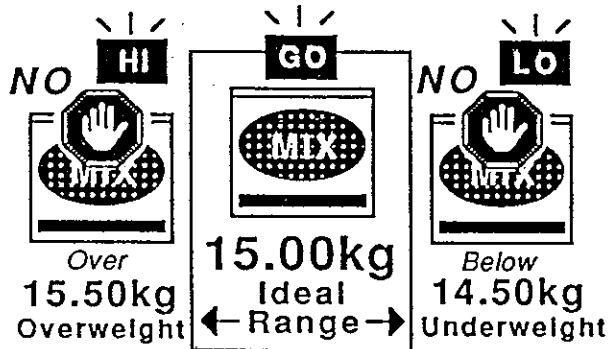

When the object(s) are placed on the weighing pan, the scale will display the weight/unit, and whether the object(s) are over the "HI" limit, under the "LO" limit, or within "GO" parameters.

If you are going to use the Comparator in Counting Mode, first enter the unit weight as explained in the Counting section above - then switch to weighing mode to set the Comparator, and finally switch back to the Counting ("pcs") Mode.

EXAMPLE

A box of mix has an ideal weight of 15.00kg. You wish to reject any box that contains more than 15.50kg of mix and less than 14.50kg.



1) Turn the scale on and press the **SET** key while in the weighing mode ("lb", "kg", or "oz"). "HI", "GO", or "LO" will be displayed.

2) Use the **MODE** (or **UNITS**) key to move through the units ("lb", "kg", "oz", "pcs") until "HI" appears and the display reads "0000" with the last "0" flashing

No decimal point or unit will be displayed when setting the comparator and the numbers entered will be valid for all weighing modes, including "pcs". If you have used the Comparator Mode previously, "HI" or "LO" may appear instead of "GO" and the previously used values will appear on the display.

3) Press **SET** to move the flashing "0" one unit to the left, since "0" is the first digit in our 15.50kg limit.



4) Press the **HI/LO-S.SIZE** key to increment the flashing digit until "0050" appears on the display, the second digit of our 15.50kg limit.



5) Press the **SET** key to move the flashing cursor one digit to the left and the third "0" will flash.



6) Use the **HI/LO-S.SIZE** key to increment the next digit. In this case press until "0550" appears on the display, the third digit of our 15.50kg limit.



7) Continue using the **SET** and **HI/LO-S.SIZE** keys to enter the remaining digits. In this case until "1550" appears on the display, this represents the 15.50kg.



8) After the high limit number has been entered, press the **MODE (or UNITS)** key again and the "LO" will appear.

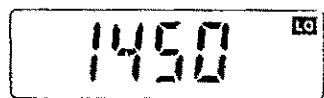

9) Enter in the low limit number in the same manner as above - in this case 14.50kg or "1450".



10) After the low limit number has been entered, use the **MODE (or UNITS)** key to move to the desired unit of measurement ("lb", "kg", "oz", "pcs"), in this case "kg".

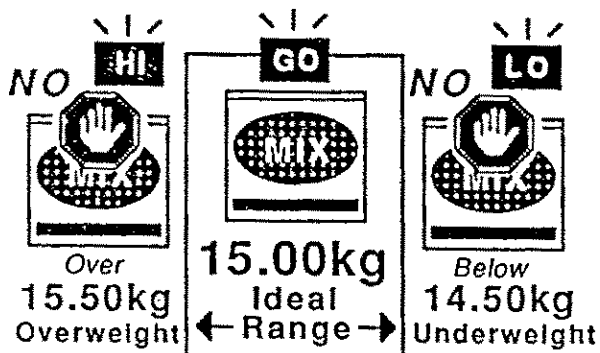

The scale has now been set so that when a box of mix containing 15.50kg or above is placed on the pan, the scale will display the weight and the "HI" will appear. If a box contains 14.50kg or less, the "LO" will appear. For every box within the range the scale will display "GO".



If the optional RS-232C output board is installed, a buzzer will sound when the HI/LO limits are exceeded (see page 16). Relay control will be possible through the same 7-pin DIN output connector used for the RS-232C Interface.

RS-232C INTERFACE OPTIONAL

Specifications

Type EIA-RS-232C
Method Asynchronous Transmission, Send Data Only.
Format Baud rate: 2400
 Data bit: 7
 Parity bit: 1 Even
 Stop bit: 1
 Code: ASCII

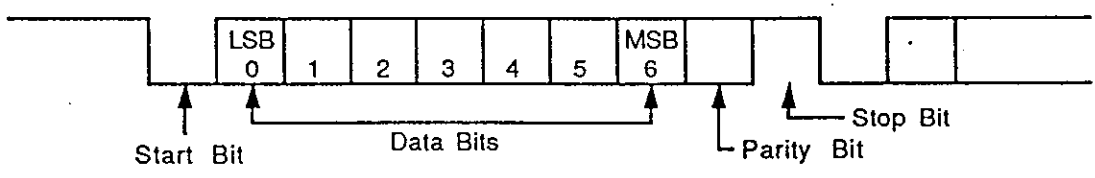

RS-232C	
1	-5V → -15V
0	+5V → +15V

Data Format

Four types of output **HEADER** are transmitted:

- OL - Overload/Underload (E, -E)
- ST - Display is Stable in oz, kg, or lb
- US - Display is Unstable (in-motion)
- QT - Display is Stable in counting mode

Data samples are transmitted by ASCII, including these codes:

- 2D (HEX) "-" (minus)
- 2B (HEX) "+" (plus)
- 2E (HEX) "." (decimal point)
- 45 (HEX) "E" (exponent)

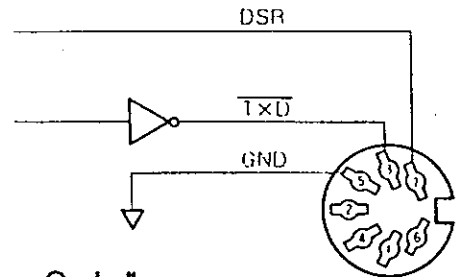

- Example data string: "ST , + 000.00 kg C_R L_F"
- Terminator will always be <CR> <LF> for transmission data. Data is transmitted continuously at the speed of the display update rate.
- Data is always transmitted as 7 digits, including ±000.00.
- Overload will be transmitted with "OL" as header and then "±999.99".
- There are four types of units "lb", "kg", "oz", or "pcs".

COMPARATOR

- When the RS-232C interface is installed, you will also gain a comparator buzzer and relay output control through the same 7-pin DIN connector used to transmit serial data to the AD-8117 compact printer, or to a computer.
- There are three kinds of output signal: "HI", "GO" and "LO".
- There are two transmission conditions:
 Transmit only when the scale is stable.
 Transmit when the scale is stable or unstable.
- The buzzer can be activated in the Comparator Mode with "HI", "GO" or "LO" signal. The following switches must be set by your dealer.

Comparator DIP Switch Settings		
1	OFF	Transmit when stable.
	ON	Transmit when stable, or unstable.
2	OFF	For "LO" signal buzzer OFF.
	ON	For "LO" signal buzzer ON.
3	OFF	For "GO" signal buzzer OFF.
	ON	For "GO" signal buzzer ON.
4	OFF	For "HI" signal buzzer OFF.
	ON	For "HI" signal buzzer ON.

- Input Specifications for the relay are:

50V DC Max.
 100 mA Max.

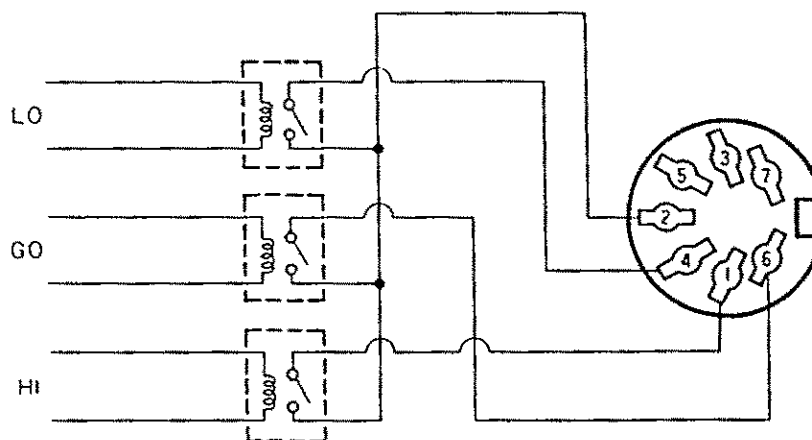

WEIGHING UNITS

- **DECIMAL POUNDS (lb).** Decimal pounds are a relatively modern invention since pounds (avoirdupois) are traditionally divided by units of 16 rather than 10. The pound can be traced back to Roman times when it was known as the "libra" weight unit and the "lb" abbreviation comes from this ancient unit. The lb is based on the average weight of 7000 grains of English corn (wheat not maize) and one "grain" unit equals 0.06479891 grams. 10 lb is the weight of 1 imperial gallon of water at 62°F. One pound has been defined as being equal to 0.45359237 kg so this is the conversion factor used to convert from kilograms to a decimal pound display or vice-versa. Decimal pounds are used in various industries because of simple decimal arithmetic.
- **OUNCES (oz).** Ounces (avoir.) are the traditional subdivision of pounds (lb). One pound contains 16 ounces and one ounce contains 16 drams. One ounce avoir is equal to 437½ grains or 28.349523125 grams and it is also the weight of one imperial fluid ounce of water at 62°F. There are 20 imperial fluid ounces to one pint and 8 pints to one gallon, so one gallon weighs 10 lb or 160 oz. One US gallon equals about 3.785 liters (3.785kg) so weighs about 133.5 oz. The abbreviation "oz" comes from "onza", meaning ounce, in old Italian.
- **KILOGRAMS (kg).** The kilogram (1,000 grams) is the SI base unit of mass and is the mass of a platinum-iridium cylinder at BIPM, Paris. It is almost but not quite, the weight of one cubic decimeter of water at 4°C. In fact, one liter of water (one kilogram) occupies a volume of 1.000028dm³ at standard atmospheric pressure of 1.01325 X 10⁵ N/m². The FV, FV-SP & FV-WP platform scales can be calibrated for span at maximum capacity (or 2/3 of maximum capacity) in kilograms or pounds (avoir).
- **"pcs" OR COUNTING.** The counting weighing mode permits you to use the scale as a pieces/parts counter in areas such as stock control departments. The scale does this by dividing a sample of 5, 10, 20, 50 or 100 pieces by the corresponding number of pieces (5, 10, 20, 50 or 100) to arrive at the average unit weight of each piece.
 - The minimum 'unit weight for counting' capacities of FV, FV-SP & FV-WP scales in "pcs" mode are:
 - FV-150/SP/WP = 50g •FV-60/SP/WP = 20g •FV-30/SP/WP = 10g
 - The maximum capacity of pieces of FV scales in "pcs" mode is 3,000 pcs.

Note: In some countries "lb", "oz" and "pcs" will not be available.

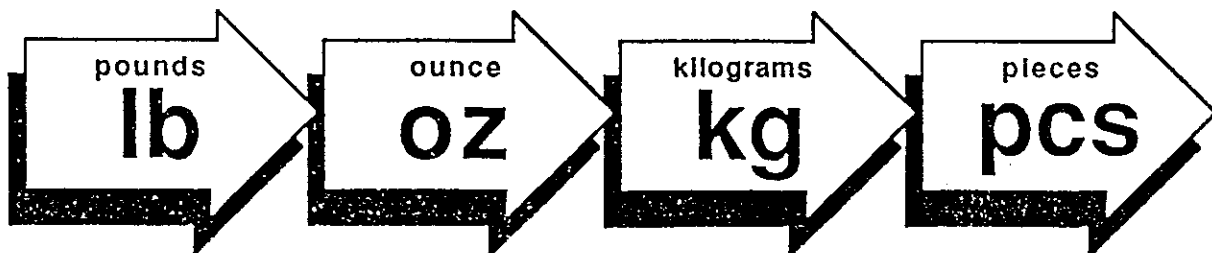

INSTALLING OPTIONS OP-01 OP-02

OP-01 Wall Mounting Kit

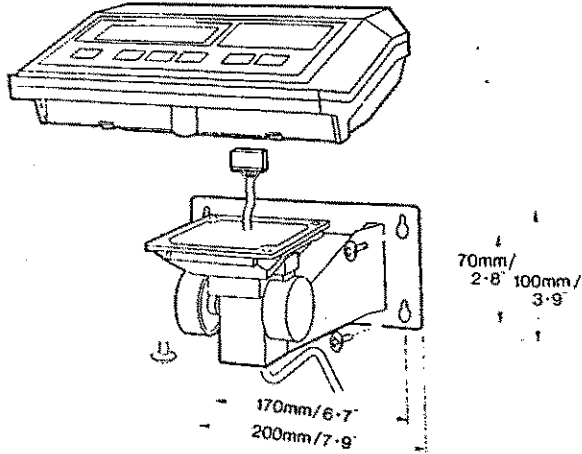

- 1) Attach the Wall Mounting Bracket to a wall (or other supportive surface) with self-tapping screws. In some wall surfaces, you will need to drill holes and use "Rawlplugs" (wall plugs) to provide a key for the screws.
- 2) Attach the Display Pod to the Wall Mounting Bracket.

This kit is not for FV-WP series

OP-02 Display Pod Extension Cable

If the Display Pod is to be used in a position remote from the platform, as a desk-top or wall mounted unit, then the standard Load Cell cable can be extended by 5 meters through the addition of this cable. The scale must be recalibrated for Zero and Span (see ZERO CALIBRATION section, page 9, and your dealer for Span Calibration) if this extension cable is used. A waterproof cover has been provided to protect the male/female connectors from splash - but a waterproof junction box may be required for some installations. Commercial scales will need to have the junction box sealed by the authorities.

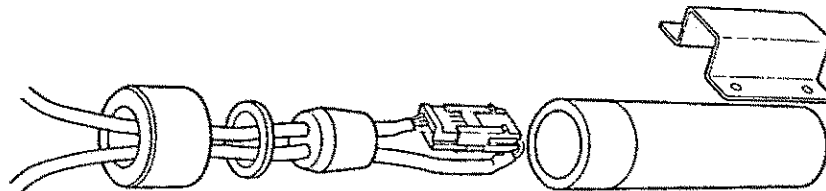

INSTALLING THE REMOTE SWITCH

This kit is not for FV-WP series

If you wish to use a remote TARE and/or ZERO switch, please connect one or two normally open switches to the remote jack plug provided with the Platform Scale. The wiring for this jack plug is shown below.

