

AD-8551R Modbus RTU Converter

Simplified Instruction Manual

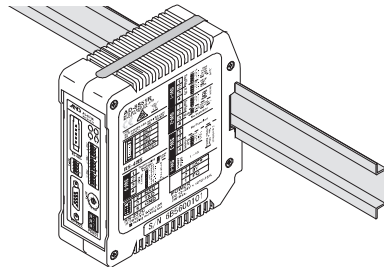

Refer to the instruction manual on the A&D home page.
URL: <https://www.aandd.jp/>

Caution

- (1) No part of this publication may be reproduced, transmitted, transcribed, or translated into any language in any form by any means without the written permission of A&D.
- (2) This manual is subject to change without notice at any time to improve the product.
- (3) The contents of this manual and the specifications of the instrument covered by this manual are subject to change for improvement without notice.
- (4) A&D bears no responsibility for claims of losses and benefits due to the operation of this device, regardless of the reason.



1WMPD4003929A

1. Introduction

This manual is an outline of the AD-8551R and the instructions for setting up and installing the equipment. Refer to the A&D website for more information on the compatible weighing devices and communication protocols. (<https://www.aandd.jp/>)

2. Features

- The AD-8551R converts RS-232C communications of the weighing device into RS-485 (Modbus RTU) communications (RS-232C/RS-485 converter).
- Use of the RS-485 enables the collection of data control of up to 31 weighing devices (addresses ranging from 1 to 63) by a single PLC.
- In addition to Modbus RTU, communications by ASCII commands can be used as the communications format. Refer to the A&D web site for details.
- The measurement value can be reset to zero (re-zero) by operation from the PLC.
- The hooks on the back of the AD-8551R allow one-touch mounting on a DIN rail.
- When connected to an AD-4212, etc., it is possible to change the response speed, perform calibration with an external weight, and supply power from the weighing device. Refer to the A&D website for compatible weighing devices.

3. Cautions

Before use, confirm the following articles for safe operation.

- This device is a precision instrument. Please handle with care.
- Avoid vibration, shock, extremely high temperature and humidity, direct sunlight, dust, splashing water, air containing salt or corrosive gases, places where inflammable gases are present.
- The operating temperature is -10°C to +50°C (14°F to 122°F).
- Ground the module.
- Keep cables away from power cables and other sources of electrical noise.
- Use a stable DC12 to DC24 V power source that does not include step down voltage and noise.
- Do not share the earth ground line and power line with other electrical power equipment.
- Do not turn on the converter until installation is complete. The converter is not equipped with a switch to turn off.
- To prevent foreign matter from entering this device, do not remove the protective cover until the installation and wiring are completed. Also, to prevent overheating, be sure to remove the protective cover before turning on the power after installation and wiring.

4. Specification

4.1. Specification

Voltage requirement	DC 12 to 24 V +10%, -15%
Power requirement	2 W Max.
Communication interface	RS-485 ×1 (For connection to control equipment) RS-232C ×1 (For connection to weighing device)
Operating conditions	-10°C to +50°C, Max 85 %RH (no condensation)
External dimensions	35.3 (W)×110.0 (H)×101.3 (D) mm
Accessory	RS-485 connector (power clamp wire mount socket)
Mass	Approximately 170 g

4.2. Modbus RTU communication specification

Item	RS-485 (Control device side)	RS-232C (Weighing device side)
Baud rate	9600~115200	2400~19200
Data bit length	8 bit fixed	7 bit fixed
parity	EVEN, ODD, NONE	EVEN fixed
Terminator (Terminal character)	Modbus RTU: A silent interval of at least 3.5 character times.	<CR><LF> fixed
Terminal resistance	Built-in (100Ω, select by switch)	
Address setting	1 to 63	

5. Front and Rear Panel

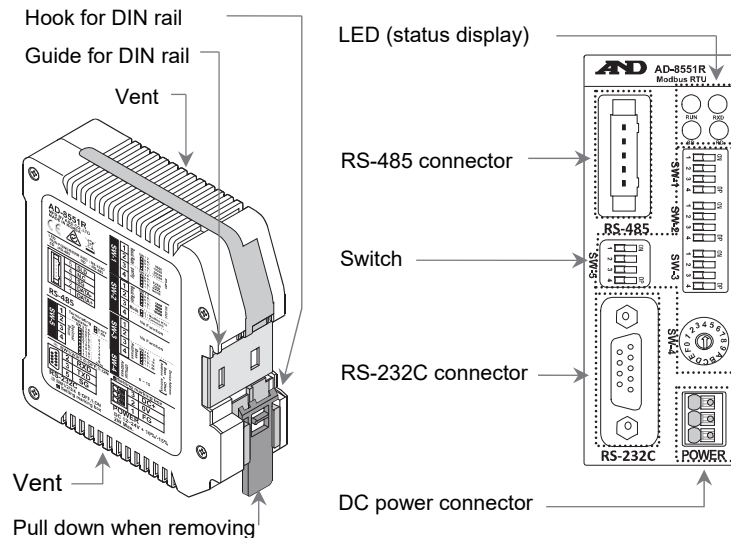

6. Connections

6.1. Power supply

Power supply wiring is not required when power is supplied from the weighing device (RS-232C connector).

※ Refer to "6.3. RS-232C"

Connections

When connecting and removing the cables, push the buttons with a driver etc.
We recommend use of rod type crimp terminals for the tips of cables.

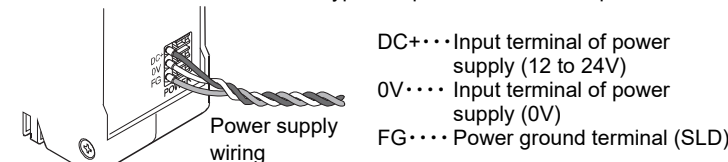

※Shields of the RS-485 connector and the shells (shields) of the RS-232C connector are connected internally to the FG of the power connector.

CAUTION

- Do not use the product at a voltage exceeding the rated voltage (DC12 to 24V +10%-15%).
- Ground the FG terminal of the switching power supply used for the power supply.

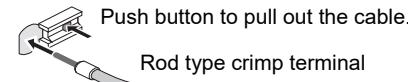

Clamp range (rated)	0.20 mm ² ~ 1.5mm ²	
Applicable wire	AWG	AWG24 ~ AWG16
	Solder plated wire	0.2 mm ² ~ 1.5mm ²
	Strand	0.2 mm ² ~ 1.5mm ²
	Bar crimp terminal DIN46228 Part1	0.25 mm ² ~ 1.5mm ²
Bar crimp terminal (With color) DIN46228 Part4	0.25 mm ² ~ 0.75mm ²	
Length	8mm	

6.2. RS-485

① RS-485 connector (Power clamp wire mount socket) ③ Branch connector

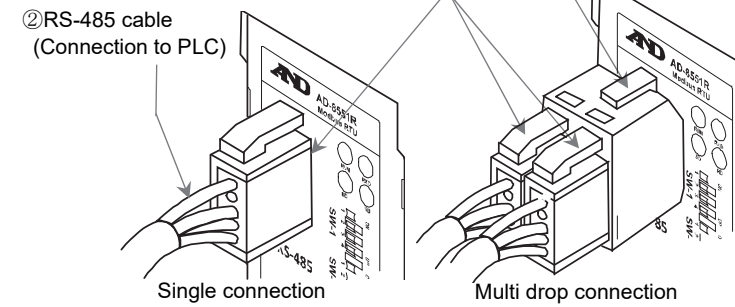

Item	Description	Accessory
① RS-485 connector (Power clamp wire mount socket)	Model:AX-35505-6200-A (Made by 3M 35505-6200-A00)	○ (1 piece)
② RS-485 cable	Twisted pair cable with shield (Wire conductor size AWG#20[0.50mm ²], Characteristic impedance 100Ω are recommended)	×
③ Branching connector	For multi drop connection Model:AX-35715-A (Made by 3M35715-L010-A00) ※RS-485 connector (power clamp wire mount socket) also needs to be purchased additionally.	×

Pin No.	Signal name	Direction	Description
1	DATA+	Input and output	Send / receive data
2	DATA-	Input and output	Send / receive data
3	SG	-	Signal ground
4	-	-	N.C
5	SLD	-	Shield

Wiring method of cable and connector (power clamp wire mount socket)

- Step 1 Insert the lead wire all the way in to the cover (yellow portion) without peeling off the cover of the lead wire. Wire the two signal lines (DATA +/-) in twisted pairs, and wire the shield to the 5-pin SLD terminal.

Step 2 Push the cover into the body and fix it.

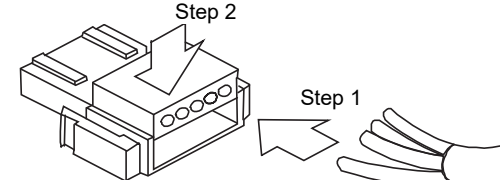

※If the host device does not have a signal ground, SG terminal wiring is not necessary.

6.3. RS-232C

RS-232C cable (Please check information on the A&D website for cables compatible with the individual measuring instrument.)

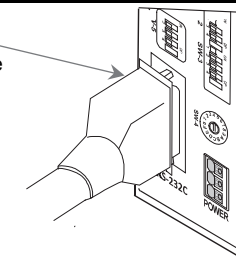

Pin No.	Signal	Direction	Description
1	(Vs)	Input	Input of power supply 0V*
2	RXD	Input	Received data
3	TXD	Output	Transmission data
5	SG	-	Signal ground
9	(Va)	Input	Input of power supply 12V*
Shell	-	-	Shield

※When using some weighing devices, such as AD-4212C, the power from the weighing weighing device can be used to operate the AD-8551R, eliminating the need for power supply wiring. Please check the A&D website for the models that can supply power.

7. Switch

Change the switch settings according to your operating environment. Be sure to turn off the AD-8551R after changing the setting. When the power is turned on, the switch setting change is reflected.

7.1. Communication setting for RS-485

SW-1	No.1	No.2	RS-485 baud rate
	OFF (0)	OFF (0)	9600
	OFF (0)	ON (1)	19200
	ON (1)	OFF (0)	38400
	ON (1)	ON (1)	115200
SW-2	No.3	No.4	RS-485 parity
	OFF (0)	OFF (0)	EVEN
	OFF (0)	ON (1)	ODD
	ON (1)	OFF (0)	No setting
	ON (1)	ON (1)	NONE
SW-3	Communication method		
	OFF (0)	Modbus RTU	
ON (1)	Command		
SW-4	No.3	No.4	Base address*1
	OFF (0)	OFF (0)	0
	OFF (0)	ON (1)	16
	ON (1)	OFF (0)	32
ON (1)	ON (1)	48	
SW-5	Offset address*		
	0 to F	0 to 15	
SW-5	Termination resistance		
	OFF (0)	None	
ON (1)	ON (1)	Yes(100Ω)	

※Device address = base address + Offset address

7.2. Communication setting of RS-232C

SW-2	No.1	No.2	RS-232C baud rate
	OFF (0)	OFF (0)	2400
	OFF (0)	ON (1)	4800
	ON (1)	OFF (0)	9600
ON (1)	ON (1)	19200	

7.3. Other settings

Setting of decimal point position (Only for Modbus RTU)

SW-5			Value stored in AD-8551R (Eg. Weighing output is 123.456 g)	
No.2	No.3	No.4	Decimal point	Weighing value
OFF (0)	OFF (0)	OFF (0)	0	123
OFF (0)	OFF (0)	ON (1)	1	1234
OFF (0)	ON (1)	OFF (0)	2	12345
OFF (0)	ON (1)	ON (1)	3	123456
ON (1)	OFF (0)	OFF (0)	4	1234560
ON (1)	OFF (0)	ON (1)	5	12345600
ON (1)	ON (1)	OFF (0)	6	123456000
ON (1)	ON (1)	ON (1)	2 (AUTO*)	12345

※The decimal point value is automatically set according to the weighing value input.

8. Confirmation

Supply power to the AD-8551R to start communication. It is possible to confirm that the wiring of each cable is connected by the LEDs of the AD-8551R.

RUN	Lights up or blinks when power is supplied	RUN	RXD
RXD	Lights up while receiving data from weighing device	SD	RD
SD	Lights up while transmitting data to PLC etc.		
RD	Lights up while receiving data from PLC etc.		

9. Communication protocol

Please check the A&D website for details on the communication protocol.